

x86-64
Assembly Language
Programming
with
Ubuntu



Ed Jorgensen
Version 1.1.13
September 2018

Cover image:

Top view of an Intel central processing unit Core i7 Skylake type core, model 6700K, released in June 2015.

Source: Eric Gaba, <https://commons.wikimedia.org/wiki/File:>

[Intel CPU Core i7 6700K Skylake top.jpg](https://commons.wikimedia.org/wiki/File:Intel_CPU_Core_i7_6700K_Skylake_top.jpg)

Cover background:

By Benjamint444 (Own work)

Source: http://commons.wikimedia.org/wiki/File%3ASwirly_belt444.jpg

Copyright © 2015, 2016, 2017, 2018 by Ed Jorgensen

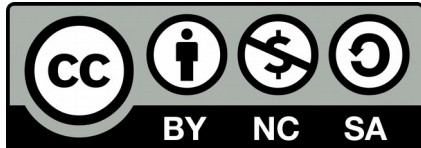

You are free:

to Share — to copy, distribute and transmit the work

to Remix — to adapt the work

Under the following conditions:

Attribution — You must attribute the work in the manner specified by the author or licensor (but not in any way that suggests that they endorse you or your use of the work).

Noncommercial — You may not use this work for commercial purposes.

Share Alike — If you alter, transform, or build upon this work, you may distribute the resulting work only under the same or similar license to this one.

Table of Contents

- 1.0 Introduction.....1**
- 1.1 Prerequisites.....1
- 1.2 What is Assembly Language.....2
- 1.3 Why Learn Assembly Language.....2
 - 1.3.1 Gain a Better Understanding of Architecture Issues.....3
 - 1.3.2 Understanding the Tool Chain.....3
 - 1.3.3 Improve Algorithm Development Skills.....3
 - 1.3.4 Improves Understanding of Functions/Procedures.....3
 - 1.3.5 Gain an Understanding of I/O Buffering.....4
 - 1.3.6 Understand Compiler Scope.....4
 - 1.3.7 Introduction to Multi-processing Concepts.....4
 - 1.3.8 Introduction to Interrupt Processing Concepts.....4
- 1.4 Additional References.....4
 - 1.4.1 Ubuntu References.....5
 - 1.4.2 BASH Command Line References.....5
 - 1.4.3 Architecture References.....5
 - 1.4.4 Tool Chain References.....5
 - 1.4.4.1 YASM References.....6
 - 1.4.4.2 DDD Debugger References.....6
- 2.0 Architecture Overview.....7**
- 2.1 Architecture Overview.....7
- 2.2 Data Storage Sizes.....8
- 2.3 Central Processing Unit.....9
 - 2.3.1 CPU Registers.....10
 - 2.3.1.1 General Purpose Registers (GPRs).....10
 - 2.3.1.2 Stack Pointer Register (RSP).....12
 - 2.3.1.3 Base Pointer Register (RBP).....12
 - 2.3.1.4 Instruction Pointer Register (RIP).....12
 - 2.3.1.5 Flag Register (rFlags).....12
 - 2.3.1.6 XMM Registers.....13
 - 2.3.2 Cache Memory.....14
- 2.4 Main Memory.....15
- 2.5 Memory Layout.....16

Table of Contents

| | | |
|------------|---|-----------|
| 2.6 | Memory Hierarchy..... | 17 |
| 2.7 | Exercises..... | 19 |
| 2.7.1 | Quiz Questions..... | 19 |
| 3.0 | Data Representation..... | 21 |
| 3.1 | Integer Representation..... | 21 |
| 3.1.1 | Two's Complement..... | 23 |
| 3.1.2 | Byte Example..... | 23 |
| 3.1.3 | Word Example..... | 24 |
| 3.2 | Unsigned and Signed Addition..... | 24 |
| 3.3 | Floating-point Representation..... | 24 |
| 3.3.1 | IEEE 32-bit Representation..... | 25 |
| 3.3.1.1 | IEEE 32-bit Representation Examples..... | 26 |
| 3.3.1.1.1 | Example $\rightarrow -7.75_{10}$ | 26 |
| 3.3.1.1.2 | Example $\rightarrow -0.125_{10}$ | 26 |
| 3.3.1.1.3 | Example $\rightarrow 41440000_{16}$ | 27 |
| 3.3.2 | IEEE 64-bit Representation..... | 27 |
| 3.3.3 | Not a Number (NaN)..... | 27 |
| 3.4 | Characters and Strings..... | 28 |
| 3.4.1 | Character Representation..... | 28 |
| 3.4.1.1 | American Standard Code for Information Interchange..... | 28 |
| 3.4.1.2 | Unicode..... | 29 |
| 3.4.2 | String Representation..... | 29 |
| 3.5 | Exercises..... | 29 |
| 3.5.1 | Quiz Questions..... | 30 |
| 4.0 | Program Format..... | 33 |
| 4.1 | Comments..... | 33 |
| 4.2 | Numeric Values..... | 33 |
| 4.3 | Defining Constants..... | 34 |
| 4.4 | Data Section..... | 34 |
| 4.5 | BSS Section..... | 35 |
| 4.6 | Text Section..... | 36 |
| 4.7 | Example Program..... | 37 |
| 4.8 | Exercises..... | 39 |
| 4.8.1 | Quiz Questions..... | 39 |
| 5.0 | Tool Chain..... | 41 |
| 5.1 | Assemble/Link/Load Overview..... | 41 |
| 5.2 | Assembler..... | 43 |

Table of Contents

| | | |
|------------|---|-----------|
| 5.2.1 | Assemble Commands..... | 43 |
| 5.2.2 | List File..... | 43 |
| 5.2.3 | Two-Pass Assembler..... | 45 |
| 5.2.3.1 | First Pass..... | 46 |
| 5.2.3.2 | Second Pass..... | 46 |
| 5.2.4 | Assembler Directives..... | 47 |
| 5.3 | Linker..... | 47 |
| 5.3.1 | Linking Multiple Files..... | 48 |
| 5.3.2 | Linking Process..... | 48 |
| 5.3.3 | Dynamic Linking..... | 50 |
| 5.4 | Assemble/Link Script..... | 50 |
| 5.5 | Loader..... | 52 |
| 5.6 | Debugger..... | 52 |
| 5.7 | Exercises..... | 53 |
| 5.7.1 | Quiz Questions..... | 53 |
| 6.0 | DDD Debugger..... | 55 |
| 6.1 | Starting DDD..... | 55 |
| 6.1.1 | DDD Configuration Settings..... | 57 |
| 6.2 | Program Execution with DDD..... | 57 |
| 6.2.1 | Setting Breakpoints..... | 57 |
| 6.2.2 | Executing Programs..... | 58 |
| 6.2.2.1 | Run / Continue..... | 60 |
| 6.2.2.2 | Next / Step..... | 60 |
| 6.2.3 | Displaying Register Contents..... | 60 |
| 6.2.4 | DDD/GDB Commands Summary..... | 62 |
| 6.2.4.1 | DDD/GDB Commands, Examples..... | 64 |
| 6.2.5 | Displaying Stack Contents..... | 65 |
| 6.2.6 | Debugger Commands File (interactive)..... | 65 |
| 6.2.6.1 | Debugger Commands File (non-interactive)..... | 66 |
| 6.2.6.2 | Debugger Commands File (non-interactive)..... | 67 |
| 6.3 | Exercises..... | 67 |
| 6.3.1 | Quiz Questions..... | 67 |
| 6.3.2 | Suggested Projects..... | 68 |
| 7.0 | Instruction Set Overview..... | 71 |
| 7.1 | Notational Conventions..... | 71 |
| 7.1.1 | Operand Notation..... | 72 |
| 7.2 | Data Movement..... | 73 |

Table of Contents

| | | |
|------------|---|------------|
| 7.3 | Addresses and Values..... | 75 |
| 7.4 | Conversion Instructions..... | 76 |
| 7.4.1 | Narrowing Conversions..... | 76 |
| 7.4.2 | Widening Conversions..... | 76 |
| 7.4.2.1 | Unsigned Conversions..... | 77 |
| 7.4.2.2 | Signed Conversions..... | 78 |
| 7.5 | Integer Arithmetic Instructions..... | 80 |
| 7.5.1 | Addition..... | 80 |
| 7.5.1.1 | Addition with Carry..... | 83 |
| 7.5.2 | Subtraction..... | 86 |
| 7.5.3 | Integer Multiplication..... | 89 |
| 7.5.3.1 | Unsigned Multiplication..... | 90 |
| 7.5.3.2 | Signed Multiplication..... | 93 |
| 7.5.4 | Integer Division..... | 97 |
| 7.6 | Logical Instructions..... | 104 |
| 7.6.1 | Logical Operations..... | 105 |
| 7.6.2 | Shift Operations..... | 106 |
| 7.6.2.1 | Logical Shift..... | 106 |
| 7.6.2.2 | Arithmetic Shift..... | 108 |
| 7.6.3 | Rotate Operations..... | 110 |
| 7.7 | Control Instructions..... | 111 |
| 7.7.1 | Labels..... | 112 |
| 7.7.2 | Unconditional Control Instructions..... | 112 |
| 7.7.3 | Conditional Control Instructions..... | 112 |
| 7.7.3.1 | Jump Out Of Range..... | 115 |
| 7.7.4 | Iteration..... | 118 |
| 7.8 | Example Program, Sum of Squares..... | 120 |
| 7.9 | Exercises..... | 121 |
| 7.9.1 | Quiz Questions..... | 122 |
| 7.9.2 | Suggested Projects..... | 125 |
| 8.0 | Addressing Modes..... | 129 |
| 8.1 | Addresses and Values..... | 129 |
| 8.1.1 | Register Mode Addressing..... | 130 |
| 8.1.2 | Immediate Mode Addressing..... | 130 |
| 8.1.3 | Memory Mode Addressing..... | 130 |
| 8.2 | Example Program, List Summation..... | 133 |
| 8.3 | Example Program, Pyramid Areas and Volumes..... | 135 |
| 8.4 | Exercises..... | 140 |

Table of Contents

| | |
|--|------------|
| 8.4.1 Quiz Questions..... | 140 |
| 8.4.2 Suggested Projects..... | 143 |
| 9.0 Process Stack..... | 145 |
| 9.1 Stack Example..... | 145 |
| 9.2 Stack Instructions..... | 146 |
| 9.3 Stack Implementation..... | 147 |
| 9.3.1 Stack Layout..... | 148 |
| 9.3.2 Stack Operations..... | 149 |
| 9.4 Stack Example..... | 151 |
| 9.5 Exercises..... | 152 |
| 9.5.1 Quiz Questions..... | 152 |
| 9.5.2 Suggested Projects..... | 154 |
| 10.0 Program Development..... | 155 |
| 10.1 Understand the Problem..... | 155 |
| 10.2 Create the Algorithm..... | 156 |
| 10.3 Implement the Program..... | 158 |
| 10.4 Test/Debug the Program..... | 160 |
| 10.5 Error Terminology..... | 161 |
| 10.5.1 Assembler Error..... | 161 |
| 10.5.2 Run-time Error..... | 161 |
| 10.5.3 Logic Error..... | 162 |
| 10.6 Exercises..... | 162 |
| 10.6.1 Quiz Questions..... | 162 |
| 10.6.2 Suggested Projects..... | 162 |
| 11.0 Macros..... | 165 |
| 11.1 Single-Line Macros..... | 165 |
| 11.2 Multi-Line Macros..... | 166 |
| 11.2.1 Macro Definition..... | 166 |
| 11.2.2 Using a Macro..... | 166 |
| 11.3 Macro Example..... | 167 |
| 11.4 Debugging Macros..... | 169 |
| 11.5 Exercises..... | 169 |
| 11.5.1 Quiz Questions..... | 169 |
| 11.5.2 Suggested Projects..... | 170 |
| 12.0 Functions..... | 171 |
| 12.1 Updated Linking Instructions..... | 171 |

Table of Contents

| | | |
|-------------|--|------------|
| 12.2 | Debugger Commands..... | 172 |
| 12.2.1 | Debugger Command, <i>next</i> | 172 |
| 12.2.2 | Debugger Command, <i>step</i> | 172 |
| 12.3 | Stack Dynamic Local Variables..... | 172 |
| 12.4 | Function Declaration..... | 173 |
| 12.5 | Standard Calling Convention..... | 173 |
| 12.6 | Linkage..... | 174 |
| 12.7 | Argument Transmission..... | 175 |
| 12.8 | Calling Convention..... | 175 |
| 12.8.1 | Parameter Passing..... | 176 |
| 12.8.2 | Register Usage..... | 177 |
| 12.8.3 | Call Frame..... | 178 |
| 12.8.3.1 | Red Zone..... | 180 |
| 12.9 | Example, Statistical Function 1 (leaf)..... | 180 |
| 12.9.1 | Caller..... | 181 |
| 12.9.2 | Callee..... | 181 |
| 12.10 | Example, Statistical Function2 (non-leaf)..... | 183 |
| 12.10.1 | Caller..... | 183 |
| 12.10.2 | Callee..... | 184 |
| 12.11 | Stack-Based Local Variables..... | 187 |
| 12.12 | Summary..... | 190 |
| 12.13 | Exercises..... | 192 |
| 12.13.1 | Quiz Questions..... | 192 |
| 12.13.2 | Suggested Projects..... | 193 |
| 13.0 | System Services..... | 197 |
| 13.1 | Calling System Services..... | 197 |
| 13.2 | Newline Character..... | 198 |
| 13.3 | Console Output..... | 199 |
| 13.3.1 | Example, Console Output..... | 200 |
| 13.4 | Console Input..... | 203 |
| 13.4.1 | Example, Console Input..... | 204 |
| 13.5 | File Open Operations..... | 208 |
| 13.5.1 | File Open..... | 209 |
| 13.5.2 | File Open/Create..... | 210 |
| 13.6 | File Read..... | 211 |
| 13.7 | File Write..... | 211 |
| 13.8 | File Operations Examples..... | 212 |
| 13.8.1 | Example, File Write..... | 212 |

Table of Contents

| | | |
|-------------|--|------------|
| 13.8.2 | Example, File Read..... | 217 |
| 13.9 | Exercises..... | 223 |
| 13.9.1 | Quiz Questions..... | 223 |
| 13.9.2 | Suggested Projects..... | 224 |
| 14.0 | Multiple Source Files..... | 227 |
| 14.1 | Extern Statement..... | 227 |
| 14.2 | Example, Sum and Average..... | 228 |
| 14.2.1 | Assembly Main..... | 228 |
| 14.2.2 | Function Source..... | 230 |
| 14.2.3 | Assemble and Link..... | 231 |
| 14.3 | Interfacing with a High-Level Language..... | 232 |
| 14.3.1 | Example, C++ Main / Assembly Function..... | 232 |
| 14.3.2 | Compile, Assemble, and Link..... | 234 |
| 14.4 | Exercises..... | 234 |
| 14.4.1 | Quiz Questions..... | 235 |
| 14.4.2 | Suggested Projects..... | 235 |
| 15.0 | Stack Buffer Overflow..... | 237 |
| 15.1 | Understanding a Stack Buffer Overflow..... | 238 |
| 15.2 | Code to Inject..... | 239 |
| 15.3 | Code Injection..... | 242 |
| 15.4 | Code Injection Protections..... | 243 |
| 15.4.1 | Data Stack Smashing Protector (or Canaries)..... | 244 |
| 15.4.2 | Data Execution Prevention..... | 244 |
| 15.4.3 | Data Address Space Layout Randomization..... | 244 |
| 15.5 | Exercises..... | 244 |
| 15.5.1 | Quiz Questions..... | 244 |
| 15.5.2 | Suggested Projects..... | 245 |
| 16.0 | Command Line Arguments..... | 247 |
| 16.1 | Parsing Command Line Arguments..... | 247 |
| 16.2 | High-Level Language Example..... | 248 |
| 16.3 | Argument Count and Argument Vector Table..... | 249 |
| 16.4 | Assembly Language Example..... | 250 |
| 16.5 | Exercises..... | 254 |
| 16.5.1 | Quiz Questions..... | 254 |
| 16.5.2 | Suggested Projects..... | 255 |
| 17.0 | Input/Output Buffering..... | 257 |

Table of Contents

| | | |
|-------------|---|------------|
| 17.1 | Why Buffer..... | 257 |
| 17.2 | Buffering Algorithm..... | 259 |
| 17.3 | Exercises..... | 262 |
| 17.3.1 | Quiz Questions..... | 262 |
| 17.3.2 | Suggested Projects..... | 263 |
| 18.0 | Floating-Point Instructions..... | 265 |
| 18.1 | Floating-Point Values..... | 265 |
| 18.2 | Floating-Point Registers..... | 266 |
| 18.3 | Data Movement..... | 266 |
| 18.4 | Integer / Floating-Point Conversion Instructions..... | 268 |
| 18.5 | Floating-Point Arithmetic Instructions..... | 270 |
| 18.5.1 | Floating-Point Addition..... | 270 |
| 18.5.2 | Floating-Point Subtraction..... | 272 |
| 18.5.3 | Floating-Point Multiplication..... | 273 |
| 18.5.4 | Floating-Point Division..... | 275 |
| 18.5.5 | Floating-Point Square Root..... | 277 |
| 18.6 | Floating-Point Control Instructions..... | 279 |
| 18.6.1 | Floating-Point Comparison..... | 280 |
| 18.7 | Floating-Point Calling Conventions..... | 283 |
| 18.8 | Example Program, Sum and Average..... | 283 |
| 18.9 | Example Program, Absolute Value..... | 285 |
| 18.10 | Exercises..... | 286 |
| 18.10.1 | Quiz Questions..... | 286 |
| 18.10.2 | Suggested Projects..... | 287 |
| 19.0 | Parallel Processing..... | 289 |
| 19.1 | Distributed Computing..... | 290 |
| 19.2 | Multiprocessing..... | 290 |
| 19.2.1 | POSIX Threads..... | 291 |
| 19.2.2 | Race Conditions..... | 292 |
| 19.3 | Exercises..... | 295 |
| 19.3.1 | Quiz Questions..... | 295 |
| 19.3.2 | Suggested Projects..... | 296 |
| 20.0 | Interrupts..... | 297 |
| 20.1 | Multi-user Operating System..... | 297 |
| 20.1.1 | Interrupt Classification..... | 298 |
| 20.1.2 | Interrupt Timing..... | 298 |
| 20.1.2.1 | Asynchronous Interrupts..... | 298 |

Table of Contents

| | | |
|-------------|--|------------|
| 20.1.2.2 | Synchronous Interrupts..... | 298 |
| 20.1.3 | Interrupt Categories..... | 299 |
| 20.1.3.1 | Hardware Interrupt..... | 299 |
| 20.1.3.1.1 | Exceptions..... | 299 |
| 20.1.3.2 | Software Interrupts..... | 300 |
| 20.2 | Interrupt Types and Levels..... | 300 |
| 20.2.1 | Interrupt Types..... | 300 |
| 20.2.2 | Privilege Levels..... | 300 |
| 20.3 | Interrupt Processing..... | 302 |
| 20.3.1 | Interrupt Service Routine (ISR)..... | 302 |
| 20.3.2 | Processing Steps..... | 302 |
| 20.3.2.1 | Suspension..... | 302 |
| 20.3.2.2 | Obtaining ISR Address..... | 302 |
| 20.3.2.3 | Jump to ISR..... | 303 |
| 20.3.2.4 | Suspension Execute ISR..... | 303 |
| 20.3.2.5 | Resumption..... | 304 |
| 20.4 | Suspension Interrupt Processing Summary..... | 304 |
| 20.5 | Exercises..... | 305 |
| 20.5.1 | Quiz Questions..... | 305 |
| 20.5.2 | Suggested Projects..... | 306 |
| 21.0 | Appendix A – ASCII Table..... | 307 |
| 22.0 | Appendix B – Instruction Set Summary..... | 309 |
| 22.1 | Notation..... | 309 |
| 22.2 | Data Movement Instructions..... | 310 |
| 22.3 | Data Conversion instructions..... | 310 |
| 22.4 | Integer Arithmetic Instructions..... | 311 |
| 22.5 | Logical, Shift, and Rotate Instructions..... | 313 |
| 22.6 | Control Instructions..... | 315 |
| 22.7 | Stack Instructions..... | 317 |
| 22.8 | Function Instructions..... | 317 |
| 22.9 | Floating-Point Data Movement Instructions..... | 317 |
| 22.10 | Floating-Point Data Conversion Instructions..... | 318 |
| 22.11 | Floating-Point Arithmetic Instructions..... | 320 |
| 22.12 | Floating-Point Control Instructions..... | 323 |
| 23.0 | Appendix C – System Services..... | 325 |
| 23.1 | Return Codes..... | 325 |
| 23.2 | Basic System Services..... | 325 |

Table of Contents

| | | |
|-------------|--|------------|
| 23.3 | File Modes..... | 327 |
| 23.4 | Error Codes..... | 328 |
| 24.0 | Appendix D – Quiz Question Answers..... | 331 |
| 24.1 | Quiz Question Answers, Chapter 1..... | 331 |
| 24.2 | Quiz Question Answers, Chapter 2..... | 331 |
| 24.3 | Quiz Question Answers, Chapter 3..... | 332 |
| 24.4 | Quiz Question Answers, Chapter 4..... | 334 |
| 24.5 | Quiz Question Answers, Chapter 5..... | 335 |
| 24.6 | Quiz Question Answers, Chapter 6..... | 336 |
| 24.7 | Quiz Question Answers, Chapter 7..... | 337 |
| 24.8 | Quiz Question Answers, Chapter 8..... | 340 |
| 24.9 | Quiz Question Answers, Chapter 9..... | 341 |
| 24.10 | Quiz Question Answers, Chapter 10..... | 341 |
| 24.11 | Quiz Question Answers, Chapter 11..... | 342 |
| 24.12 | Quiz Question Answers, Chapter 12..... | 342 |
| 24.13 | Quiz Question Answers, Chapter 13..... | 343 |
| 24.14 | Quiz Question Answers, Chapter 14..... | 343 |
| 24.15 | Quiz Question Answers, Chapter 15..... | 344 |
| 24.16 | Quiz Question Answers, Chapter 16..... | 344 |
| 24.17 | Quiz Question Answers, Chapter 17..... | 345 |
| 24.18 | Quiz Question Answers, Chapter 18..... | 345 |
| 24.19 | Quiz Question Answers, Chapter 19..... | 346 |
| 24.20 | Quiz Question Answers, Chapter 20..... | 346 |
| 25.0 | Alphabetical Index..... | 349 |

Illustration Index

| | |
|---|-----|
| Illustration 1: Computer Architecture..... | 7 |
| Illustration 2: CPU Block Diagram..... | 15 |
| Illustration 3: Little-Endian Data Layout..... | 16 |
| Illustration 4: General Memory Layout..... | 17 |
| Illustration 5: Memory Hierarchy..... | 18 |
| Illustration 6: Overview: Assemble, Link, Load..... | 42 |
| Illustration 7: Little-Endian, Multiple Variable Data Layout..... | 44 |
| Illustration 8: Linking Multiple Files..... | 49 |
| Illustration 9: Initial Debugger Screen..... | 56 |
| Illustration 10: Debugger Screen with Breakpoint Set..... | 58 |
| Illustration 11: Debugger Screen with Green Arrow..... | 59 |
| Illustration 12: DDD Command Bar..... | 60 |
| Illustration 13: Register Window..... | 61 |
| Illustration 14: MOV Instruction Overview..... | 73 |
| Illustration 15: Integer Multiplication Overview..... | 90 |
| Illustration 16: Integer Division Overview..... | 99 |
| Illustration 17: Logical Operations..... | 105 |
| Illustration 18: Logical Shift Overview..... | 107 |
| Illustration 19: Logical Shift Operations..... | 107 |
| Illustration 20: Arithmetic Left Shift..... | 109 |
| Illustration 21: Arithmetic Right Shift..... | 109 |
| Illustration 22: Process Memory Layout..... | 148 |
| Illustration 23: Process Memory Layout Example..... | 149 |
| Illustration 24: Stack Frame Layout..... | 179 |
| Illustration 25: Stack Frame Layout with Red Zone..... | 180 |
| Illustration 26: Stack Call Frame Example..... | 238 |
| Illustration 27: Stack Call Frame Corruption..... | 243 |
| Illustration 28: Argument Vector Layout..... | 250 |
| Illustration 29: Privilege Levels..... | 301 |
| Illustration 30: Interrupt Processing Overview..... | 304 |

Table of Contents

If you give someone a program, you will frustrate them for a day; if you teach them to program, you will frustrate them for a lifetime.

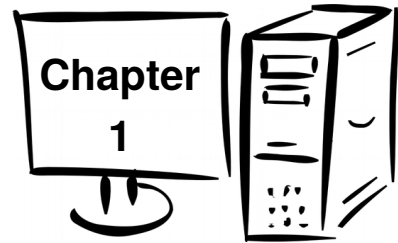

1.0 Introduction

The purpose of this text is to provide a reference for University level assembly language and systems programming courses. Specifically, this text addresses the x86-64¹ instruction set for the popular x86-64 class of processors using the Ubuntu 64-bit Operating System (OS). While the provided code and various examples should work under any Linux-based 64-bit OS, they have only been tested under Ubuntu 14.04 LTS (64-bit).

The x86-64 is a Complex Instruction Set Computing (CISC²) CPU design. This refers to the internal processor design philosophy. CISC processors typically include a wide variety of instructions (sometimes overlapping), varying instructions sizes, and a wide range of addressing modes. The term was retroactively coined in contrast to Reduced Instruction Set Computer (RISC³).

1.1 Prerequisites

It must be noted that the text is not geared toward learning how to program. It is assumed that the reader has already become proficient in a high-level programming language. Specifically, the text is generally geared toward a compiled, C-based high-level language such as C, C++, or Java. Many of the explanations and examples assume the reader is already familiar with programming concepts such as declarations, arithmetic operations, control structures, iteration, function calls, functions, indirection (i.e., pointers), and variable scoping issues.

Additionally, the reader should be comfortable using a Linux-based operating system including using the command line. If the reader is new to Linux, the Additional References section has links to some useful documentation.

1 For more information, refer to: <http://en.wikipedia.org/wiki/X86-64>

2 For more information, refer to: http://en.wikipedia.org/wiki/Complex_instruction_set_computing

3 For more information, refer to: http://en.wikipedia.org/wiki/Reduced_instruction_set_computing

1.2 What is Assembly Language

The typical question asked by students is 'why learn assembly?'. Before addressing that question, let's clarify what exactly assembly language is.

Assembly language is machine specific. For example, code written for an x86-64 processor will not run on a different processor such as a RISC processor (popular in tablets and smart-phones).

Assembly language is a “low level” language and provides the basic instructional interface to the computer processor. Assembly language is as close to the processor as you can get as a programmer. Programs written in a high-level language are translated into assembly language in order for the processor to execute the program. The high-level language is an abstraction between the language and the actual processor instructions. As such, the idea that “assembly is dead” is nonsense.

Assembly language gives you direct control of the system's resources. This involves setting processor registers, accessing memory locations, and interfacing with other hardware elements. This requires a significantly deeper understanding of exactly how the processor and memory work.

1.3 Why Learn Assembly Language

The goal of this text is to provide a comprehensive introduction to programming in assembly language. The reasons for learning assembly language are more about understanding how a computer works instead of developing large programs. Since assembly language is machine specific, the lack of portability is very limiting for programming projects.

The process of actually learning assembly language involves writing non-trivial programs to perform specific low-level actions including arithmetic operations, function calls, using stack-dynamic local variables, and operating system interaction for activities such as input/output. Just looking at small assembly language programs will not be enough.

In the long run, learning the underlying principles, including assembly language, is what makes the difference between a coding technician unable to cope with changing languages and a computer scientist who is able to adapt to the ever-changing technologies.

The following sections provide some detail on the various, more specific reasons for learning assembly language.

1.3.1 Gain a Better Understanding of Architecture Issues

Learning and spending some time working at the assembly language level provides a richer understanding of the underlying computer architecture. This includes the basic instruction set, processor registers, memory addressing, hardware interfacing, and Input/Output. Since ultimately all programs execute at this level, knowing the capabilities of assembly language provides useful insights into what is possible, what is easy, and what might be more difficult or slower.

1.3.2 Understanding the Tool Chain

The tool chain is the name for the process of taking code written by a human and converting it into something that the computer can directly execute. This includes the compiler, or assembler in our case, the linker, the loader, and the debugger. In reference to compiling, beginning programmers are told “just do this” with little explanation of the complexity involved in the process. Working at the low level can help provide the basis for understanding and appreciating the details of the tool chain.

1.3.3 Improve Algorithm Development Skills

Working with assembly language and writing low-level programs helps programmers improve algorithm development skills by practicing with a language that requires more thought and more attention to detail. In the highly unlikely event that a program does not work the first time, debugging assembly language also provides practice debugging and requires a more nuanced approach since just adding a bunch of output statements is more difficult at the assembly language level. This typically involves a more comprehensive use of a debugger which is a useful skill for any programmer.

1.3.4 Improves Understanding of Functions/Procedures

Working with assembly language provides a greatly improved understanding of how function/procedure calls work. This includes the contents and structure of the function call frame, also referred to as the activation record. Depending on the specific instance, the activation record might include stack-based arguments, preserved registers, and/or stack dynamic local variables. There are some significant implementation and security implications regarding stack dynamic local variables that are best understood working at a low level. Due to the security implications, it would be appropriate to remind readers to always use their powers for good. Additionally, use of the stack and the associated call frame is the basis for recursion and understanding the fairly straightforward implementation of recursive functions.

1.3.5 Gain an Understanding of I/O Buffering

In a high-level language, input/output instructions and the associated buffering operations can appear magical. Working at the assembly language level and performing some low-level input/output operations provides a more detailed understanding of how input/output and buffering really works. This includes the differences between interactive input/output, file input/output, and the associated operating system services.

1.3.6 Understand Compiler Scope

Programming with assembly language, after having already learned a high-level language, helps ensure programmers understand the scope and capabilities of a compiler. Specifically, this means learning what the compiler does and does not do in relation to the computer architecture.

1.3.7 Introduction to Multi-processing Concepts

This text will also provide a brief introduction to multi-processing concepts. The general concepts of distributed and multi-core programming are presented with the focus being placed on shared memory, threaded processing. It is the author's belief that truly understanding the subtle issues associated with threading such as shared memory and race conditions is most easily understood at the low-level.

1.3.8 Introduction to Interrupt Processing Concepts

The underlying fundamental mechanism in which modern multi-user computers work is based on interrupts. Working at a low-level is the best place to provide an introduction to the basic concepts associated with interrupt handling, interrupt service handles, and vector interrupts.

1.4 Additional References

Some key references for additional information are noted in the following sections. These references provide much more extensive and detailed information.

If any of these locations change, a web search will be able to find the new location.

1.4.1 Ubuntu References

There is significant documentation available for the Ubuntu OS. The principal user guide is as follows:

- [Ubuntu Community Wiki](#)
- [Getting Started with Ubuntu 16.04](#)

In addition, there are many other sites dedicated to providing help using Ubuntu (or other Linux-based OS's).

1.4.2 BASH Command Line References

BASH is the default shell for Ubuntu. The reader should be familiar with basic command line operations. Some additional references are as follows:

- [Linux Command Line](#) (on-line Tutorial and text)
- [An Introduction to the Linux Command Shell For Beginners](#) (pdf)

In addition, there are many other sites dedicated to providing information regarding the BASH command shell.

1.4.3 Architecture References

Some key references published by Intel provide a detailed technical description of the architecture and programming environment of Intel processors supporting IA-32 and Intel 64 Architectures.

- [Intel® 64 and IA-32 Architectures Software Developer's Manual: Basic Architecture.](#)
- [Intel 64 and IA-32 Architectures Software Developer's Manual: Instruction Set Reference.](#)
- [Intel 64 and IA-32 Architectures Software Developer's Manual: System Programming Guide.](#)

If the embedded links do not work, an Internet search can help find the new location.

1.4.4 Tool Chain References

The tool chain includes the assembler, linker, loader, and debugger. Chapter 5, Tool Chain, provides an overview of the tool chain being used in this text. The following references provide more detailed information and documentation.

1.4.4.1 YASM References

The YASM assembler is an open source assembler commonly available on Linux-based systems. The YASM references are as follows:

- [Yasm Web Site](#)
- [Yasm Documentation](#)

Additional information regarding YASM may be at a number of assembly language sites and can be found through an Internet search.

1.4.4.2 DDD Debugger References

The DDD debugger is an open source debugger capable of supporting assembly language.

- [DDD Web Site](#)
- [DDD Documentation](#)

Additional information regarding DDD may be at a number of assembly language sites and can be found through an Internet search.

Warning, keyboard not found. Press enter to continue.

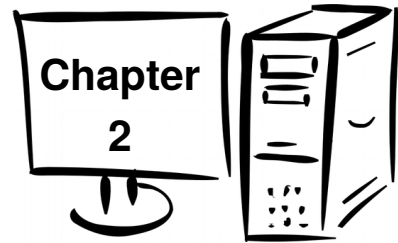

2.0 Architecture Overview

This chapter presents a basic, general overview of the x86-64 architecture. For a more detailed explanation, refer to the additional references noted in Chapter 1, Introduction.

2.1 Architecture Overview

The basic components of a computer include a Central Processing Unit (CPU), Primary Storage or Random Access Memory (RAM), Secondary Storage, Input/Output devices (e.g., screen, keyboard, mouse), and an interconnection referred to as the Bus.

A very basic diagram of the computer architecture is as follows:

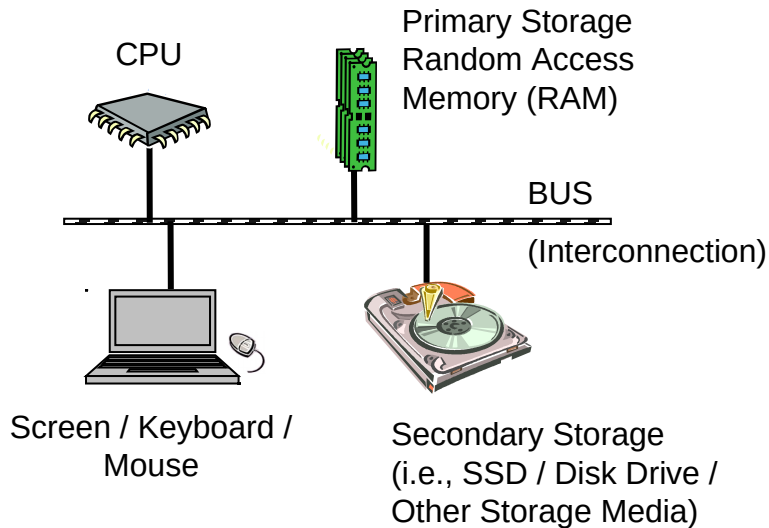

Illustration 1: Computer Architecture

The architecture is typically referred to as the Von Neumann Architecture⁴, or the Princeton architecture, and was described in 1945 by the mathematician and physicist John von Neumann.

Programs and data are typically stored on secondary storage (e.g., disk drive or solid state drive). When a program is executed, it must be copied from secondary storage into the primary storage or main memory (RAM). The CPU executes the program from primary storage or RAM.

Primary storage or main memory is also referred to as volatile memory since when power is removed, the information is not retained and thus lost. Secondary storage is referred to as non-volatile memory since the information is retained when powered off.

For example, consider storing a term paper on secondary storage (i.e., disk). When the user starts to write or edit the term paper, it is copied from the secondary storage medium into primary storage (i.e., RAM or main memory). When done, the updated version is typically stored back to the secondary storage (i.e., disk). If you have ever lost power while editing a document (assuming no battery or uninterruptable power supply), losing the unsaved work will certainly clarify the difference between volatile and non-volatile memory.

2.2 Data Storage Sizes

The x86-64 architecture supports a specific set of data storage size elements, all based on powers of two. The supported storage sizes are as follows:

| Storage | Size (bits) | Size (bytes) |
|-----------------|-------------|--------------|
| Byte | 8-bits | 1 byte |
| Word | 16-bits | 2 bytes |
| Double-word | 32-bits | 4 bytes |
| Quadword | 64-bits | 8 bytes |
| Double quadword | 128-bits | 16 bytes |

Lists or arrays (sets of memory) can be reserved in any of these types.

These storage sizes have a direct correlation to variable declarations in high-level languages (e.g., C, C++, Java, etc.).

⁴ For more information, refer to: http://en.wikipedia.org/wiki/Von_Neumann_architecture

For example, C/C++ declarations are mapped as follows:

| C/C++ Declaration | Storage | Size (bits) | Size (bytes) |
|-------------------|-------------|-------------|--------------|
| char | Byte | 8-bits | 1 byte |
| short | Word | 16-bits | 2 bytes |
| int | Double-word | 32-bits | 4 bytes |
| unsigned int | Double-word | 32-bits | 4 bytes |
| long ⁵ | Quadword | 64-bits | 8 bytes |
| long long | Quadword | 64-bits | 8 bytes |
| char * | Quadword | 64-bits | 8 bytes |
| int * | Quadword | 64-bits | 8 bytes |
| float | Double-word | 32-bits | 4 bytes |
| double | Quadword | 64-bits | 8 bytes |

The asterisk indicates an address variable. For example, **int *** means the address of an integer. Other high-level languages typically have similar mappings.

2.3 Central Processing Unit

The Central Processing Unit⁶ (CPU) is typically referred to as the “brains” of the computer since that is where the actual calculations are performed. The CPU is housed in a single chip, sometimes called a processor, chip, or die⁷. The cover image shows one such CPU.

The CPU chip includes a number of functional units, including the Arithmetic Logic Unit⁸ (ALU) which is the part of the chip that actually performs the arithmetic and logical calculations. In order to support the ALU, processor registers⁹ and cache¹⁰ memory are also included “on the die” (term for inside the chip). The CPU registers and cache memory are described in subsequent sections.

It should be noted that the internal design and configuration of a modern processor is

⁵ *Note*, the 'long' type declaration is compiler dependent. Type shown is for **gcc** and **g++** compilers.

⁶ For more information, refer to: http://en.wikipedia.org/wiki/Central_processing_unit

⁷ For more information, refer to: [http://en.wikipedia.org/wiki/Die_\(integrated_circuit\)](http://en.wikipedia.org/wiki/Die_(integrated_circuit))

⁸ For more information, refer to: http://en.wikipedia.org/wiki/Arithmetic_logic_unit

⁹ For more information, refer to: http://en.wikipedia.org/wiki/Processor_register

¹⁰ For more information, refer to: [http://en.wikipedia.org/wiki/Cache_\(computing\)](http://en.wikipedia.org/wiki/Cache_(computing))

quite complex. This section provides a very simplified, high-level view of some key functional units within a CPU. Refer to the footnotes or additional references for more information.

2.3.1 CPU Registers

A CPU register, or just register, is a temporary storage or working location built into the CPU itself (separate from memory). Computations are typically performed by the CPU using registers.

2.3.1.1 General Purpose Registers (GPRs)

There are sixteen, 64-bit General Purpose Registers (GPRs). The GPRs are described in the following table. A GPR register can be accessed with all 64-bits or some portion or subset accessed.

| 64-bit register | Lowest 32-bits | Lowest 16-bits | Lowest 8-bits |
|-----------------|----------------|----------------|---------------|
| rax | eax | ax | al |
| rbx | ebx | bx | bl |
| rcx | ecx | cx | cl |
| rdx | edx | dx | dl |
| rsi | esi | si | sil |
| rdi | edi | di | dil |
| rbp | ebp | bp | bpl |
| rsp | esp | sp | spl |
| r8 | r8d | r8w | r8b |
| r9 | r9d | r9w | r9b |
| r10 | r10d | r10w | r10b |
| r11 | r11d | r11w | r11b |
| r12 | r12d | r12w | r12b |
| r13 | r13d | r13w | r13b |
| r14 | r14d | r14w | r14b |
| r15 | r15d | r15w | r15b |

Additionally, some of the GPR registers are used for dedicated purposes as described in the later sections.

When using data element sizes less than 64-bits (i.e., 32-bit, 16-bit, or 8-bit), the lower portion of the register can be accessed by using a different register name as shown in the table.

For example, when accessing the lower portions of the 64-bit **rax** register, the layout is as follows:

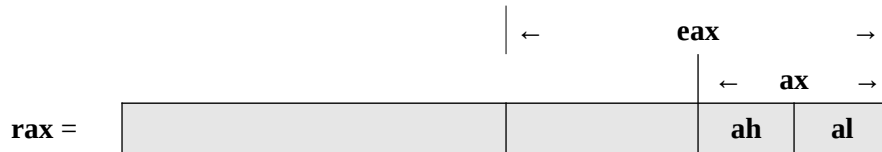

As shown in the diagram, the first four registers, **rax**, **rbx**, **rcx**, and **rdx** also allow the bits 8-15 to be accessed with the **ah**, **bh**, **ch**, and **dh** register names. This is provided for legacy support and will not be used in this text.

The ability to access portions of the register means that, if the quadword **rax** register is set to $50,000,000,000_{10}$ (fifty billion), the **rax** register would contain the following value in hex.

rax = 0000 000B A43B 7400

If a subsequent operation sets the word **ax** register to $50,000_{10}$ (fifty-thousand, which is $C350_{16}$), the **rax** register would contain the following value in hex.

rax = 0000 000B A43B C350

In this case, when the lower 16-bit **ax** portion of the 64-bit **rax** register is set, the upper 48-bits are unaffected. Note the change in AX (from 7400_{16} to $C350_{16}$).

If a subsequent operation sets the byte sized **al** register to 50_{10} (fifty, which is 32_{16}), the **rax** register would contain the following value in hex.

rax = 0000 000B A43B C332

When the lower 8-bit **al** portion of the 64-bit **rax** register is set, the upper 56-bits are unaffected. Note the change in AL (from 50_{16} to 32_{16}).

For 32-bit register operations, the upper 32-bits is cleared (set to zero's). Generally, this is not an issue since operations on 32-bit registers do not use the upper 32-bits of the register. For unsigned values, this can be useful to convert from 32-bits to 64-bits.

However, this will not work for signed conversions from 32-bit to 64-bit values. Specifically, it will potentially provide incorrect results for numbers negative values. Refer to Chapter 3, Data Representation for additional information regarding the representation of signed values.

2.3.1.2 Stack Pointer Register (RSP)

One of the CPU registers, **rsp**, is used to point to the current top of the stack. The **rsp** register should not be used for data or other uses. Additional information regarding the stack and stack operations is provided in Chapter 9, Process Stack.

2.3.1.3 Base Pointer Register (RBP)

One of the CPU registers, **rbp**, is used as a base pointer during function calls. The **rbp** register should not be used for data or other uses. Additional information regarding the functions and function calls is provided in Chapter 12, Functions.

2.3.1.4 Instruction Pointer Register (RIP)

In addition to the GPRs, there is a special register, **rip**, that is used by the CPU to point to the *next instruction to be executed*. Specifically, since the **rip** points to the next instruction, that means the instruction being pointed to by **rip**, and shown in the debugger, has not yet been executed. This is an important distinction which can be confusing when reviewing code in a debugger.

2.3.1.5 Flag Register (rFlags)

The flag register, **rFlags**, is used for status and CPU control information. The **rFlag** register is updated by the CPU after each instruction and not directly accessible by programs. This register stores status information about the instruction that was just executed. Of the 64-bits in the **rFlag** register, many are reserved for future use.

The following table shows some of the status bits in the flag register.

| Name | Symbol | Bit | Use |
|--------|--------|-----|--|
| Carry | CF | 0 | Used to indicate if the previous operation resulted in a carry. |
| Parity | PF | 2 | Used to indicate if the last byte has an even number of 1's (i.e., even parity). |
| Adjust | AF | 4 | Used to support Binary Coded Decimal operations. |

| | | | |
|-----------|----|----|---|
| Zero | ZF | 6 | Used to indicate if the previous operation resulted in a zero result. |
| Sign | SF | 7 | Used to indicate if the result of the previous operation resulted in a 1 in the most significant bit (indicating negative in the context of signed data). |
| Direction | DF | 10 | Used to specify the direction (increment or decrement) for some string operations. |
| Overflow | OF | 11 | Used to indicate if the previous operation resulted in an overflow. |

There are a number of additional bits not specified in this text. More information can be obtained from the additional references noted in Chapter 1, Introduction.

2.3.1.6 XMM Registers

There are a set of dedicated registers used to support 64-bit and 32-bit floating-point operations and Single Instruction Multiple Data (SIMD) instructions. The SIMD instructions allow a single instruction to be applied simultaneously to multiple data items. Used effectively, this can result in a significant performance increase. Typical applications include some graphics processing and digital signal processing.

The XMM registers as follows:

| 128-bit Registers |
|-------------------|
| xmm0 |
| xmm1 |
| xmm2 |
| xmm3 |
| xmm4 |
| xmm5 |
| xmm6 |
| xmm7 |
| xmm8 |
| xmm9 |

| |
|---------------|
| xmm.10 |
| xmm.11 |
| xmm.12 |
| xmm.13 |
| xmm.14 |
| xmm.15 |

Note, some of the more recent X86-64 processors support 256-bit XMM registers. This will not be an issue for the programs in this text.

Additionally, the XMM registers are used to support the Streaming SIMD Extensions (SSE). The SSE instructions are out of the scope of this text. More information can be obtained from the Intel references (as noted in Chapter 1, Introduction).

2.3.2 Cache Memory

Cache memory is a small subset of the primary storage or RAM located in the CPU chip. If a memory location is accessed, a copy of the value is placed in the cache. Subsequent accesses to that memory location that occur in quick succession are retrieved from the cache location (internal to the CPU chip). A memory read involves sending the address via the bus to the memory controller, which will obtain the value at the requested memory location, and send it back through the bus. Comparatively, if a value is in cache, it would be much faster to access that value.

A cache hit occurs when the requested data can be found in a cache, while a cache miss occurs when it cannot. Cache hits are served by reading data from the cache, which is faster than reading from main memory. The more requests that can be served from cache, the faster the system will typically perform. Successive generations of CPU chips have increased cache memory and improved cache mapping strategies in order to improve overall performance.

A block diagram of a typical CPU chip configuration is as follows:

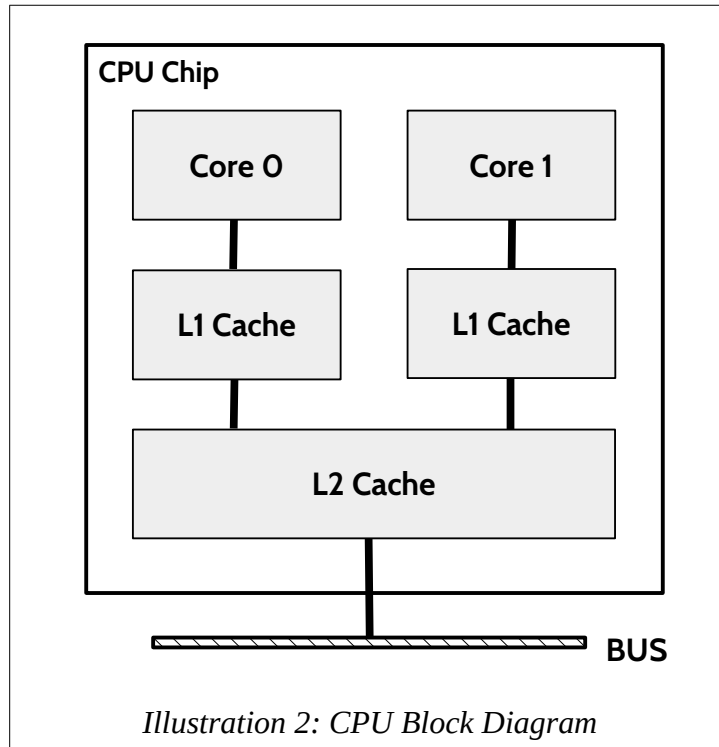

Current chip designs typically include an L1 cache per core and a shared L2 cache. Many of the newer CPU chips will have an additional L3 cache.

As can be noted from the diagram, all memory accesses travel through each level of cache. As such, there is a potential for multiple, duplicate copies of the value (CPU register, L1 cache, L2 cache, and main memory). This complication is managed by the CPU and is not something the programmer can change. Understanding the cache and associated performance gain is useful in understanding how a computer works.

2.4 Main Memory

Memory can be viewed as a series of bytes, one after another. That is, memory is *byte addressable*. This means each memory address holds one byte of information. To store a double-word, four bytes are required which use four memory addresses.

Additionally, architecture is *little-endian*. This means that the Least Significant Byte (LSB) is stored in the lowest memory address. The Most Significant Byte (MSB) is stored in the highest memory location.

Chapter 2.0 ◀ Architecture Overview

For a double-word (32-bits), the MSB and LSB are allocated as shown below.

| | | | | | | | | | | | | | | | | | | | | | | | | | | | | | | | |
|------------|----|----|----|----|----|----|----|----|----|----|----|----|----|----|----|------------|----|----|----|----|----|---|---|---|---|---|---|---|---|---|---|
| 31 | 30 | 29 | 28 | 27 | 26 | 25 | 24 | 23 | 22 | 21 | 20 | 19 | 18 | 17 | 16 | 15 | 14 | 13 | 12 | 11 | 10 | 9 | 8 | 7 | 6 | 5 | 4 | 3 | 2 | 1 | 0 |
| MSB | | | | | | | | | | | | | | | | LSB | | | | | | | | | | | | | | | |

For example, assuming the value of, $5,000,000_{10}$ ($004C4B40_{16}$), is to be placed in a double-word variable named **var1**.

For a little-endian architecture, the memory picture would be as follows:

| variable name | value | Address (in hex) |
|----------------------|--------------|-------------------------|
| | ? | 0100100C |
| | 00 | 0100100B |
| | 4C | 0100100A |
| | 4B | 01001009 |
| var1 → | 40 | 01001008 |
| | ? | 01001007 |

Illustration 3: Little-Endian Data Layout

Based on the little-endian architecture, the LSB is stored in the lowest memory address and the MSB is stored in the highest memory location.

2.5 Memory Layout

The general memory layout for a program is as shown:

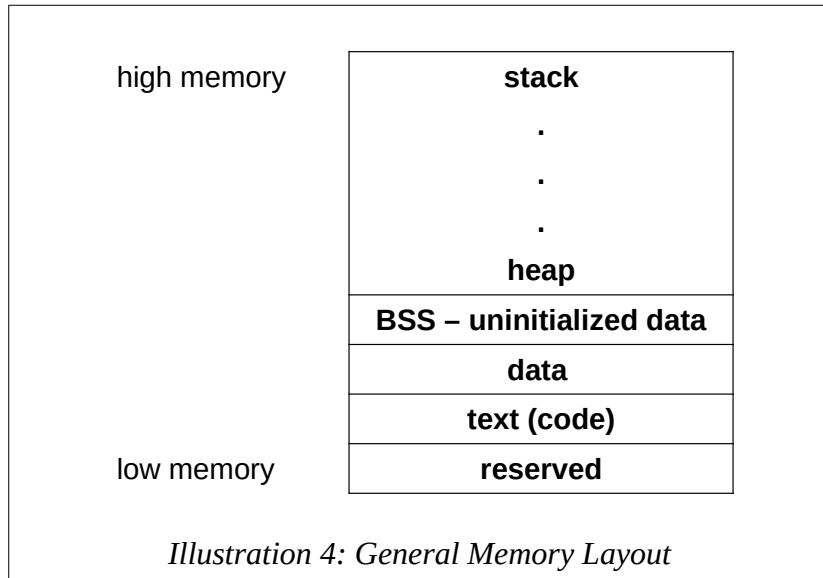

The reserved section is not available to user programs. The text (or code) section is where the machine language¹¹ (i.e., the 1's and 0's that represent the code) is stored. The data section is where the initialized data is stored. This includes declared variables that have been provided an initial value at assemble time. The uninitialized data section, typically called BSS section, is where declared variables that have not been provided an initial value are stored. If accessed before being set, the value will not be meaningful. The heap is where dynamically allocated data will be stored (if requested). The stack starts in high memory and grows downward.

Later sections will provide additional detail for the text and data sections.

2.6 Memory Hierarchy

In order to fully understand the various different memory levels and associated usage, it is useful to review the memory hierarchy¹². In general terms, faster memory is more expensive and slower memory blocks are less expensive. The CPU registers are small, fast, and expensive. Secondary storage devices such as disk drives and Solid State Drives (SSD's) are larger, slower, and less expensive. The overall goal is to balance performance with cost.

11 For more information, refer to: http://en.wikipedia.org/wiki/Machine_code

12 For more information, refer to: http://en.wikipedia.org/wiki/Memory_hierarchy

An overview of the memory hierarchy is as follows:

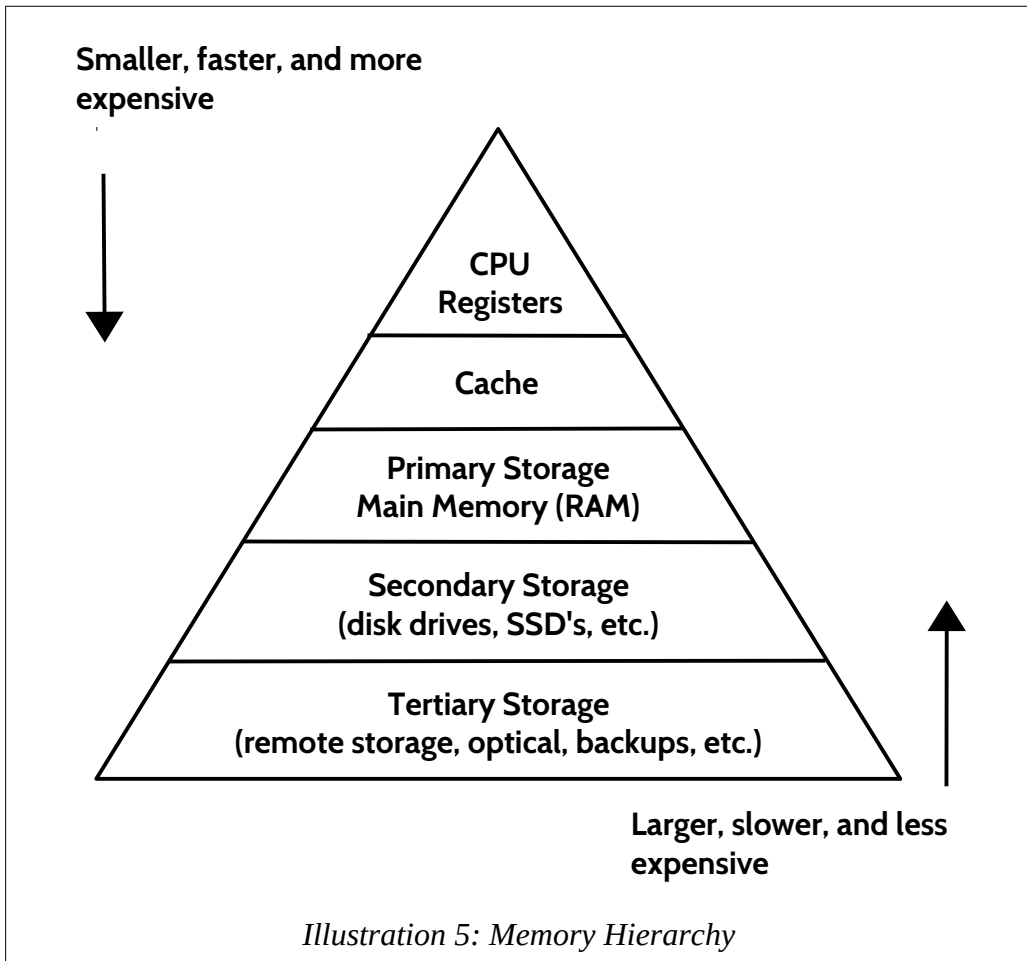

Where the top of the triangle represents the fastest, smallest, and most expensive memory. As we move down levels, the memory becomes slower, larger, and less expensive. The goal is to use an effective balance between the small, fast, expensive memory and the large, slower, and cheaper memory.

Some typical performance and size characteristics are as follows:

| Memory Unit | Example Size | Typical Speed |
|--|---|----------------------------------|
| Registers | 16, 64-bit registers | ~1 nanoseconds ¹³ |
| Cache Memory | 4 - 8+ Megabytes ¹⁴ (L1 and L2) | ~5-60 nanoseconds |
| Primary Storage (i.e., main memory) | 2 – 32+ Gigabytes ¹⁵ | ~100-150 nanoseconds |
| Secondary Storage (i.e., disk, SSD's, etc.) | 500 Gigabytes – 4+ Terabytes ¹⁶ | ~3-15 milliseconds ¹⁷ |

Based on this table, a primary storage access at 100 nanoseconds (100×10^{-9}) is 30,000 times faster than a secondary storage access, at 3 milliseconds (3×10^{-3}).

The typical speeds improve over time (and these are already out of date). The key point is the relative difference between each memory unit is significant. This difference between the memory units applies even as newer, faster SSDs are being utilized.

2.7 Exercises

Below are some questions based on this chapter.

2.7.1 Quiz Questions

Below are some quiz questions.

- 1) Draw a picture of the VonNeumann Architecture.
- 2) What architecture component connects the memory to the CPU?
- 3) Where are programs stored when the computer is turned off?
- 4) Where must programs be located when they are executing?
- 5) How does cache memory help overall performance?
- 6) How many bytes does a C++ integer declared with the declaration **int** use?

13 For more information, refer to: <http://en.wikipedia.org/wiki/Nanosecond>

14 For more information, refer to: <http://en.wikipedia.org/wiki/Megabyte>

15 For more information, refer to: <http://en.wikipedia.org/wiki/Gigabyte>

16 For more information, refer to: <http://en.wikipedia.org/wiki/Terabyte>

17 For more information, refer to: <http://en.wikipedia.org/wiki/Millisecond>

Chapter 2.0 ◀ Architecture Overview

- 7) On the Intel X86-64 architecture, how many **bytes** can be stored at each address?
- 8) Given the 32-bit hex $004C4B40_{16}$ what is the:
 1. Least Significant Byte (LSB)
 1. Most Significant Byte (MSB)
- 9) Given the 32-bit hex $004C4B40_{16}$, show the little-endian memory layout showing each byte in memory.
- 10) Draw a picture of the layout for the **rax** register.
- 11) How many bits does each of the following represent:
 1. **al**
 2. **rcx**
 3. **bx**
 4. **edx**
 5. **r11**
 6. **r8b**
 7. **sil**
 8. **r14w**
- 12) Which register points to the next instruction to be executed?
- 13) Which register points to the current top of the stack?
- 14) If **al** is set to 05_{16} and **ax** is set to 0007_{16} , **eax** is set to 00000020_{16} , and **rax** is set to 0000000000000000_{16} , and show the final complete contents of the complete **rax** register.
- 15) If the **rax** register is set to $81,985,529,216,486,895_{10}$ ($123456789ABCDEF_{16}$), what are the contents of the following registers in **hex**?
 1. **al**
 2. **ax**
 3. **eax**
 4. **rax**

*There are 10 types of people in the world;
those that understand binary and those that
don't.*

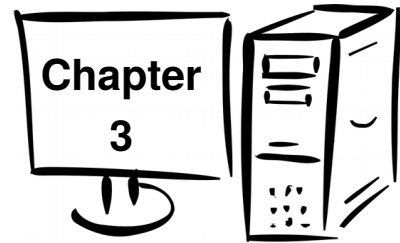

3.0 Data Representation

Data representation refers to how information is stored within the computer. There is a specific method for storing integers which is different than storing floating-point values which is different than storing characters. This chapter presents a brief summary of the integer, floating-point, and ASCII representation schemes.

It is assumed the reader is already generally familiar with binary, decimal, and hex numbering systems.

It should be noted that if not specified, a number is in base-10. Additionally, a number preceded by 0x is a hex value. For example, $19 = 19_{10} = 13_{16} = 0x13$.

3.1 Integer Representation

Representing integer numbers refers to how the computer stores or represents a number in memory. The computer represents numbers in binary (1's and 0's). However, the computer has a limited amount of space that can be used for each number or variable. This directly impacts the size, or range, of the number that can be represented. For example, a byte (8-bits) can be used to represent 2^8 or 256 different numbers. Those 256 different numbers can be *unsigned* (all positive) in which case we can represent any number between 0 and 255 (inclusive). If we choose *signed* (positive and negative values), then we can represent any number between -128 and +127 (inclusive).

If that range is not large enough to handle the intended values, a larger size must be used. For example, a word (16-bits) can be used to represent 2^{16} or 65,536 different values, and a double-word (32-bits) can be used to represent 2^{32} or 4,294,967,296 different numbers. So, if you wanted to store a value of 100,000 then a double-word would be required.

Chapter 3.0 ◀ Data Representation

As you may recall from C, C++, or Java, an integer declaration (e.g., **int** <variable>) is a single double-word which can be used to represent values between -2^{31} ($-2,147,483,648$) and $+2^{31} - 1$ ($+2,147,483,647$).

The following table shows the ranges associated with typical sizes:

| Size | Size | Unsigned Range | Signed Range |
|------------------------|-----------|--------------------|----------------------------------|
| Bytes (8-bits) | 2^8 | 0 to 255 | -128 to +127 |
| Words (16-bits) | 2^{16} | 0 to 65,535 | -32,768 to +32,767 |
| Double-words (32-bits) | 2^{32} | 0 to 4,294,967,295 | -2,147,483,648 to +2,147,483,647 |
| Quadword | 2^{64} | 0 to $2^{64} - 1$ | $-(2^{63})$ to $2^{63} - 1$ |
| Double quadword | 2^{128} | 0 to $2^{128} - 1$ | $-(2^{127})$ to $2^{127} - 1$ |

In order to determine if a value can be represented, you will need to know the size of the storage element (byte, word, double-word, quadword, etc.) being used and if the values are signed or unsigned.

- For representing *unsigned* values within the range of a given storage size, standard binary is used.
- For representing *signed* values within the range, **two's complement** is used. Specifically, the two's complement encoding process applies to the values in the negative range. For values within the positive range, standard binary is used.

For example, the unsigned byte range can be represented using a number line as follows:

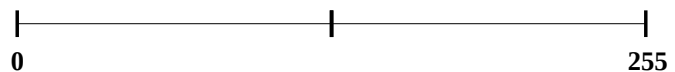

For example, the signed byte range can also be represented using a number line as follows:

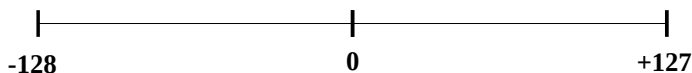

The same concept applies to halfwords and words which have larger ranges.

Since unsigned values have a different, positive only, range than signed values, there is overlap between the values. This can be very confusing when examining variables in memory (with the debugger).

For example, when the unsigned and signed values are within the overlapping positive range (0 to +127):

- A signed byte representation of 12_{10} is $0x0C_{16}$
- An unsigned byte representation of 12_{10} is also $0x0C_{16}$

When the unsigned and signed values are outside the overlapping range:

- A signed byte representation of -15_{10} is $0xF1_{16}$
- An unsigned byte representation of 241_{10} is also $0xF1_{16}$

This overlap can cause confusion unless the data types are clearly and correctly defined.

3.1.1 Two's Complement

The following describes how to find the two's complement representation for negative values (not positive values).

To take the two's complement of a number:

1. take the one's complement (negate)
2. add 1 (in binary)

The same process is used to encode a decimal value into two's complement and from two's complement back to decimal. The following sections provide some examples.

3.1.2 Byte Example

For example, to find the byte size (8-bits), two's complement representation of -9 and -12.

| | |
|---------------|-----------------|
| 9 (8+1) = | 00001001 |
| Step 1 | 11110110 |
| Step 2 | 11110111 |
| | |
| -9 (in hex) = | F7 |

| | |
|----------------|-----------------|
| 12 (8+4) = | 00001100 |
| Step 1: | 11110011 |
| | 11110100 |
| | |
| -12 (in hex) = | F4 |

Note, all bits for the given size, byte in this example, must be specified.

3.1.3 Word Example

To find the word size (16-bits), two's complement representation of -18 and -40.

| | |
|-------------|------------------------|
| 18 (16+2) = | 000000000010010 |
| Step 1 | 111111111101101 |
| Step 2 | 111111111101110 |
| <hr/> | |
| -18 (hex) = | 0xFFEE |

| | |
|-------------|------------------------|
| 40 (32+8) = | 000000000101000 |
| Step 1 | 111111111010111 |
| Step 2 | 111111111011000 |
| <hr/> | |
| -40 (hex) = | 0xFFD8 |

Note, all bits for the given size, words in these examples, must be specified.

3.2 Unsigned and Signed Addition

As previously noted, the unsigned and signed representations may provide different interpretations for the final value being represented. However, the addition and subtraction operations are the same. For example:

| | | |
|-------|-------|-----------------|
| | 241 | 11110001 |
| + | 7 | 0000111 |
| <hr/> | | |
| | 248 | 11111000 |
| <hr/> | | |
| | 248 = | F8 |

| | | |
|-------|------|-----------------|
| | -15 | 11110001 |
| + | 7 | 0000111 |
| <hr/> | | |
| | -8 | 11111000 |
| <hr/> | | |
| | -8 = | F8 |

The final result of 0xF8 may be interpreted as 248 for unsigned representation and -8 for a signed representation. Additionally, 0xF8₁₆ is the ° (degree symbol) in the ASCII table.

As such, it is very important to have a clear definition of the sizes (byte, halfword, word, etc.) and types (signed, unsigned) of data for the operations being performed.

3.3 Floating-point Representation

The representation issues for floating-point numbers are more complex. There are a series of floating-point representations for various ranges of the value. For simplicity, we will look primarily at the IEEE 754 32-bit floating-point standard.

3.3.1 IEEE 32-bit Representation

The IEEE 754 32-bit floating-point standard is defined as follows:

| | | | | | | | | | | | | | | | | | | | | | | | | | | | | | | | |
|----|-----------------|----|----|----|----|----|----|----|----------|----|----|----|----|----|----|----|----|----|----|----|----|---|---|---|---|---|---|---|---|---|---|
| 31 | 30 | 29 | 28 | 27 | 26 | 25 | 24 | 23 | 22 | 21 | 20 | 19 | 18 | 17 | 16 | 15 | 14 | 13 | 12 | 11 | 10 | 9 | 8 | 7 | 6 | 5 | 4 | 3 | 2 | 1 | 0 |
| s | biased exponent | | | | | | | | fraction | | | | | | | | | | | | | | | | | | | | | | |

Where s is the sign (0 => positive and 1 => negative). More formally, this can be written as;

$$N = (-1)^s \times 1.F \times 2^{E-127}$$

When representing floating-point values, the first step is to convert floating-point value into binary. The following table provides a brief reminder of how binary handles fractional components:

| | | | | | | | | | |
|-----|----------|----------|----------|----------|---|----------|----------|----------|-----|
| | 2^3 | 2^2 | 2^1 | 2^0 | . | 2^{-1} | 2^{-2} | 2^{-3} | |
| ... | 8 | 4 | 2 | 1 | . | 1/2 | 1/4 | 1/8 | ... |
| | 0 | 0 | 0 | 0 | . | 0 | 0 | 0 | |

For example, 100.101_2 would be 4.625_{10} . For repeating decimals, calculating the binary value can be time consuming. However, there is a limit since computers have finite storage sizes (32-bits in this example).

The next step is to show the value in normalized scientific notation in binary. This means that the number should have a single, non-zero leading digit to the left of the decimal point. For example, 8.125_{10} is 1000.001_2 (or $1000.001_2 \times 2^0$) and in binary normalized scientific notation that would be written as 1.000001×2^3 (since the decimal point was moved three places to the left). Of course, if the number was 0.125_{10} the binary would be 0.001_2 (or $0.001_2 \times 2^0$) and the normalized scientific notation would be 1.0×2^{-3} (since the decimal point was moved three places to the right). The numbers after the leading 1, **not** including the leading 1, are stored left-justified in the fraction portion of the double-word.

The next step is to calculate the *biased exponent*, which is the exponent from the normalized scientific notation with plus the bias. The bias for the IEEE 754 32-bit floating-point standard is 127_{10} . The result should be converted to a byte (8-bits) and stored in the biased exponent portion of the word.

Note, converting from the IEEE 754 32-bit floating-point representation to the decimal value is done in reverse, however leading 1 must be added back (as it is not stored in the word). Additionally, the bias is subtracted (instead of added).

3.3.1.1 IEEE 32-bit Representation Examples

This section presents several examples of encoding and decoding floating-point representation for reference.

3.3.1.1.1 Example → -7.75₁₀

For example, to find the IEEE 754 32-bit floating-point representation for -7.75₁₀:

Example 1: -7.75

- determine sign -7.75 => 1 (since negative)
- convert to binary -7.75 = -0111.11₂
- normalized scientific notation = 1.1111 x 2²
- compute biased exponent 2₁₀ + 127₁₀ = 129₁₀
 - and convert to binary = 10000001₂
- write components in binary:

| | | |
|------|----------|--------------------------|
| sign | exponent | mantissa |
| 1 | 10000001 | 111100000000000000000000 |
- convert to hex (split into groups of 4)

| | | | |
|----------|----------|----------|----------|
| 11000000 | 11110000 | 00000000 | 00000000 |
| 1100 | 0000 | 1111 | 1000 |
| C | 0 | F | 8 |
| | 0 | 0 | 0 |
| | 0 | 0 | 0 |
- final result: **C0F8 0000₁₆**

3.3.1.1.2 Example → -0.125₁₀

For example, to find the IEEE 754 32-bit floating-point representation for -0.125₁₀:

Example 2: -0.125

- determine sign -0.125 => 1 (since negative)
- convert to binary -0.125 = -0.001₂
- normalized scientific notation = 1.0 x 2⁻³
- compute biased exponent -3₁₀ + 127₁₀ = 124₁₀
 - and convert to binary = 01111100₂
- write components in binary:

| | | |
|------|----------|--------------------------|
| sign | exponent | mantissa |
| 1 | 01111100 | 000000000000000000000000 |

- convert to hex (split into groups of 4)

```

            10111110000000000000000000000000
            1011 1110 0000 0000 0000 0000 0000 0000
              B   E   0   0   0   0   0   0
            
```
- final result: **BE00 0000₁₆**

3.3.1.1.3 Example → **41440000₁₆**

For example, given the IEEE 754 32-bit floating-point representation 41440000₁₆ find the decimal value:

Example 3: **41440000₁₆**

- convert to binary

```

            0100 0001 0100 0100 0000 0000 0000 00002
            
```
- split into components

```

            0 1000010 1000100000000000000000002
            
```
- determine exponent
 - and remove bias
 $1000010_2 = 130_{10}$
 $130_{10} - 127_{10} = 3_{10}$
- determine sign
 - 0 => positive
- write result
 $+1.10001 \times 2^3 = +1100.01 = +12.25$

3.3.2 IEEE 64-bit Representation

The IEEE 754 64-bit floating-point standard is defined as follows:

| | | | | | | |
|----|-----------------|--|----|----|----------|---|
| 63 | 62 | | 52 | 51 | | 0 |
| s | biased exponent | | | | fraction | |

The representation process is the same, however the format allows for an 11-bit biased exponent (which support large and smaller values). The 11-bit biased exponent uses a bias of ±1023.

3.3.3 Not a Number (NaN)

When a value is interpreted as a floating-point value and it does not conform to the defined standard (either for 32-bit or 64-bit), then it cannot be used as a floating-point value. This might occur if an integer representation is treated as a floating-point representation or a floating-point arithmetic operation (add, subtract, multiple, or divide) results in a value that is too large or too small to be represented. The incorrect format or unrepresentable number is referred to as a **NaN** which is an abbreviation for *not a number*.

3.4 Characters and Strings

In addition to numeric data, symbolic data is often required. Symbolic or non-numeric data might include an important message such as “Hello World”¹⁸ a common greeting for first programs. Such symbols are well understood by English language speakers. Computer memory is designed to store and retrieve numbers. Consequently, the symbols are represented by assigning numeric values to each symbol or character.

3.4.1 Character Representation

In a computer, a character¹⁹ is a unit of information that corresponds to a symbol such as a letter in the alphabet. Examples of characters include letters, numerical digits, common punctuation marks (such as "." or "!"), and whitespace. The general concept also includes control characters, which do not correspond to symbols in a particular language, but to other information used to process text. Examples of control characters include carriage return or tab.

3.4.1.1 American Standard Code for Information Interchange

Characters are represented using the American Standard Code for Information Interchange (ASCII²⁰). Based on the ASCII table, each character and control character is assigned a numeric value. When using ASCII, the character displayed is based on the assigned numeric value. This only works if everyone agrees on common values, which is the purpose of the ASCII table. For example, the letter “A” is defined as 65_{10} (0x41). The 0x41 is stored in computer memory, and when displayed to the console, the letter “A” is shown. Refer to Appendix A for the complete ASCII table.

Additionally, numeric symbols can be represented in ASCII. For example, “9” is represented as 57_{10} (0x39) in computer memory. The “9” can be displayed as output to the console. If sent to the console, the integer value 9_{10} (0x09) would be interpreted as an ASCII value which in the case would be a tab.

It is very important to understand the difference between characters (such as “2”) and integers (such a 2_{10}). Characters can be displayed to the console, but cannot be used for calculations. Integers can be used for calculations, but cannot be displayed to the console (without changing the representation).

A character is typically stored in a byte (8-bits) of space. This works well since memory is byte addressable.

18 For more information, refer to: http://en.wikipedia.org/wiki/Hello,_World!_program

19 For more information, refer to: [http://en.wikipedia.org/wiki/Character_\(computing\)](http://en.wikipedia.org/wiki/Character_(computing))

20 For more information, refer to: <http://en.wikipedia.org/wiki/ASCII>

3.4.1.2 Unicode

It should be noted that Unicode²¹ is more current standard that includes support for different languages. The Unicode Standard provides series of different encoding schemes (UTF-8, UTF-16, UTF-32, etc.) in order to provide a unique number for every character, no matter what platform, device, application or language. The most common encoding scheme, UTF-8, the ASCII English text looks exactly the same in UTF-8 as it did in ASCII. Additional bytes are used for other characters as needed. Details regarding Unicode representation are not addressed in this text.

3.4.2 String Representation

A string²² is a series of ASCII characters, typically terminated with a NULL. The NULL is a non-printable ASCII control character. Since it is not printable, it can be used to mark the end of a string.

For example, the string “Hello” would be represented as follows:

| | | | | | | |
|-----------------------|------|------|------|------|------|------|
| Character | “H” | “e” | “l” | “l” | “o” | NULL |
| ASCII Value (decimal) | 72 | 101 | 108 | 108 | 111 | 0 |
| ASCII Value (hex) | 0x48 | 0x65 | 0x6C | 0x6C | 0x6F | 0x0 |

A string may consist partially or completely of numeric symbols. For example, the string “19653” would be represented as follows:

| | | | | | | |
|-----------------------|------|------|------|------|------|------|
| Character | “1” | “9” | “6” | “5” | “3” | NULL |
| ASCII Value (decimal) | 49 | 57 | 54 | 53 | 51 | 0 |
| ASCII Value (hex) | 0x31 | 0x39 | 0x36 | 0x35 | 0x33 | 0x0 |

Again, it is very important to understand the difference between the string “19653” (using 6 bytes) and the single integer 19,653₁₀ (which can be stored in a single word which is 2 bytes).

3.5 Exercises

Below are some questions based on this chapter.

21 For more information, refer to: <http://en.wikipedia.org/wiki/Unicode>

22 For more information, refer to: [http://en.wikipedia.org/wiki/String_\(computer_science\)](http://en.wikipedia.org/wiki/String_(computer_science))

3.5.1 Quiz Questions

Below are some quiz questions.

- 1) Provide the range for each of the following:
 1. signed byte
 2. unsigned byte
 3. signed word
 4. unsigned word
 5. signed double-word
 6. unsigned double-word
- 2) Provide the decimal values of the following binary numbers:
 1. 0000101_2
 2. 0001001_2
 3. 0001101_2
 4. 0010101_2
- 3) Provide the hex, **byte** size, two's complement values of the following decimal values. *Note*, two hex digits expected.
 1. -3_{10}
 2. $+11_{10}$
 3. -9_{10}
 4. -21_{10}
- 4) Provide the hex, **word** size, two's complement values of the following decimal values. *Note*, four hex digits expected.
 1. -17_{10}
 2. $+17_{10}$
 3. -31_{10}
 4. -138_{10}

- 5) Provide the hex, **double-word** size, two's complement values of the following decimal values. *Note*, eight hex digits expected.
1. -11_{10}
 2. -27_{10}
 3. $+7_{10}$
 4. -261_{10}
- 6) Provide the decimal values of the following hex, double-word sized, two's complement values.
1. FFFFFFFB_{16}
 2. FFFFFFEA_{16}
 3. FFFFFFF3_{16}
 4. FFFFFFF8_{16}
- 7) Which of the following decimal values has an **exact** representation in binary?
1. 0.1
 2. 0.2
 3. 0.3
 4. 0.4
 5. 0.5
- 8) Provide the decimal representation of the following IEEE 32-bit floating-point values.
1. $0xC1440000$
 2. $0x41440000$
 3. $0xC0D00000$
 4. $0xC0F00000$

Chapter 3.0 ◀ Data Representation

- 9) Provide hex, IEEE 32-bit floating-point representation of the following floating-point values.
1. $+11.25_{10}$
 2. -17.125_{10}
 3. $+21.875_{10}$
 4. -0.75_{10}
- 10) What is the ASCII code, in hex, for each of the following characters:
1. "A"
 2. "a"
 3. "0"
 4. "8"
 5. tab
- 11) What are the ASCII values, in hex, for each of the following strings:
1. "World"
 2. "123"
 3. "Yes!?"

I would love to change the world, but they won't give me the source code.

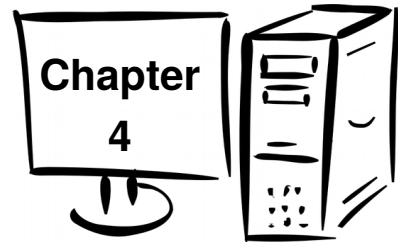

4.0 Program Format

This chapter summarizes the formatting requirements for assembly-language programs. The formatting requirements are specific to the **yasm** assembler. Other assemblers may be slightly different. A complete assembly language program is presented to demonstrate the appropriate program formatting.

A properly formatted assembly source file consists of several main parts;

- Data section where initialized data is declared and defined.
- BSS section where uninitialized data is declared.
- Text section where code is placed.

The following sections summarize the basic formatting requirements. Only the basic formatting and assembler syntax are presented. For additional information, refer to the **yasm** reference manual (as noted in Chapter 1, Introduction).

4.1 Comments

The semicolon (;) is used to note program comments. Comments (using the ;) may be placed anywhere, including after an instruction. Any characters after the ; are ignored by the assembler. This can be used to explain steps taken in the code or to comment out sections of code.

4.2 Numeric Values

Number values may be specified in decimal, hex, or octal.

When specifying hex, or base-16 values, they are preceded with a **0x**. For example, to specify 127 as hex, it would be **0x7f**.

When specifying octal, or-base-8 values, they are followed by a **q**. For example, to specify 511 as octal, it would be **777q**.

The default radix (base) is decimal, so no special notation is required for decimal (base-10) numbers.

4.3 Defining Constants

Constants are defined with **equ**. The general format is:

<name> equ <value>

The value of a constant cannot be changed during program execution.

The constants are substituted for their defined values during the assembly process. As such, a constant is not assigned a memory location. This makes the constant more flexible since it is not assigned a specific type/size (byte, word, double-word, etc.). The values are subject to the range limitations of the intended use. For example, the following constant,

SIZE equ 10000

could be used as a word or a double-word, but not a byte.

4.4 Data Section

The initialized data must be declared in the "section .data" section. There must be a space after the word 'section'. All initialized variables and constants are placed in this section. Variable names must start with a letter, followed by letters or numbers, including some special characters (such as the underscore, "_"). Variable definitions must include the name, the data type, and the initial value for the variable.

The general format is:

<variableName> <dataType> <initialValue>

Refer to the following sections for a series of examples using various data types.

The supported data types are as follows:

| Declaration | |
|-------------|--------------------|
| db | 8-bit variable(s) |
| dw | 16-bit variable(s) |

| | |
|------------|-------------------------------|
| dd | 32-bit variable(s) |
| dq | 64-bit variable(s) |
| ddq | 128-bit variable(s) → integer |
| dt | 128-bit variable(s) → float |

These are the primary assembler directives for initialized data declarations. Other directives are referenced in different sections.

Initialized arrays are defined with comma separated values.

Some simple examples include:

```

bVar      db      10                ; byte variable
cVar      db      "H"                ; single character
str       db      "Hello World"      ; string
wVar      dw      5000                ; word variable
dVar      dd      50000               ; 32-bit variable
arr       dd      100, 200, 300       ; 3 element array
flt1     dd      3.14159              ; 32-bit float
qVar     dq      1000000000           ; 64-bit variable

```

The value specified must be able to fit in the specified data type. For example, if the value of a byte sized variables is defined as 500, it would generate an assembler error.

4.5 BSS Section

Uninitialized data is declared in the "section .bss" section. There must be a space after the word 'section'. All uninitialized variables are declared in this section. Variable names start with a letter followed by letters or numbers including some special characters (such as the underscore, "_"). Variable definitions must include the name, the data type, and the count.

The general format is:

```

<variableName>    <resType>    <count>

```

Refer to the following sections for a series of examples using various data types.

The supported data types are as follows:

| Declaration | |
|--------------|---------------------|
| resb | 8-bit variable(s) |
| resw | 16-bit variable(s) |
| resd | 32-bit variable(s) |
| resq | 64-bit variable(s) |
| resdq | 128-bit variable(s) |

These are the primary assembler directives for uninitialized data declarations. Other directives are referenced in different sections.

Some simple examples include:

```

bArr      resb      10          ; 10 element byte array
wArr      resw      50          ; 50 element word array
dArr      resd      100         ; 100 element double array
qArr      resq      200         ; 200 element quad array

```

The allocated array is not initialized to any specific value.

4.6 Text Section

The code is placed in the "section .text" section. There must be a space after the word 'section'. The instructions are specified one per line and each must be a valid instruction with the appropriate required operands.

The text section will include some headers or labels that define the initial program entry point. For example, assuming a basic program using the standard system linker, the following declarations must be included.

```

global _start
_start:

```

No special label or directives are required to terminate the program. However, a system service should be used to inform the operating system that the program should be terminated and the resources, such as memory, recovered and re-utilized. Refer to the example program in the following section.

4.7 Example Program

A very simple assembly language program is presented to demonstrate the appropriate program formatting.

```

; Simple example demonstrating basic program
; format and layout.

; *****
; Some basic data declarations

section    .data

; -----
; Define constants

EXIT_SUCCESS    equ    0        ; successful operation
SYS_exit        equ    60       ; call code for terminate

; -----
; Byte (8-bit) variable declarations

bVar1          db      17
bVar2          db      9
bResult        db      0

; -----
; Word (16-bit) variable declarations

wVar1          dw      17000
wVar2          dw      9000
wResult        dw      0

; -----
; Double-word (32-bit) variable declarations

dVar1          dd      17000000
dVar2          dd      9000000
dResult        dd      0

```

Chapter 4.0 ◀ Program Format

```
; -----
; Quadword (64-bit) variable declarations

qVar1          dq      170000000
qVar2          dq      90000000
qResult        dq      0

; *****
; Code Section

section        .text
global _start
_start:

; Performs a series of very basic addition operations
; to demonstrate basic program format.

; -----
; Byte example
; bResult = bVar1 + bVar2

    mov     al, byte [bVar1]
    add    al, byte [bVar2]
    mov    byte [bResult], al

; -----
; Word example
; wResult = wVar1 + wVar2

    mov     ax, word [wVar1]
    add    ax, word [wVar2]
    mov    word [wResult], ax

; -----
; Double-word example
; dResult = dVar1 + dVar2

    mov     eax, dword [dVar1]
    add    eax, dword [dVar2]
    mov    dword [dResult], eax
```

```

; -----
; Quadword example
; qResult = qVar1 + qVar2

    mov    rax, qword [qVar1]
    add    rax, qword [qVar2]
    mov    qword [qResult], rax

; *****
; Done, terminate program.

last:
    mov    rax, SYS_exit          ; Call code for exit
    mov    rdi, EXIT_SUCCESS     ; Exit program with success
    syscall

```

This example program will be referenced and further explained in the following chapters.

4.8 Exercises

Below are some questions based on this chapter.

4.8.1 Quiz Questions

Below are some quiz questions.

- 1) What is the name of the assembler being used in this chapter?
- 2) How are comments marked in an assembly language program?
- 3) What is the name of the section where the initialized data declared?
- 4) What is the name of the section where the uninitialized data declared?
- 5) What is the name of the section where the code is placed?
- 6) What is the data declaration for each of the following variables with the given values:
 1. byte sized variable **bNum** set to 10_{10}
 2. word sized variable **wNum** set to $10,291_{10}$
 3. double-word sized variable **dwNum** set to $2,126,010_{10}$
 4. quadword sized variable **qwNum** set to $10,000,000,000_{10}$

Chapter 4.0 ◀ Program Format

- 7) What is the uninitialized data declaration for each of the following:
 1. byte sized array named **bArr** with 100 elements
 2. word sized array named **wArr** with 3000 elements
 3. double-word sized array named **dwArr** with 200 elements
 4. quadword sized array named **qArr** with 5000 elements
- 8) What are the required declarations to signify the start of a program (in the text section)?

There are two ways to write error-free programs; only the third works.

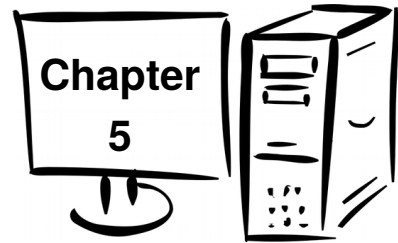

5.0 Tool Chain

In general, the set of programming tools used to create a program is referred to as the **tool chain**²³. For the purposes of this text, the tool chain consists of the following;

- Assembler
- Linker
- Loader
- Debugger

While there are many options for the tool chain, this text uses a fairly standard set of open-source tools that work well together and fully support the x86 64-bit environment.

Each of these programming tools is explained in the following sections.

5.1 Assemble/Link/Load Overview

In broad terms, the assemble, link, and load process is how programmer written source files are converted into an executable program.

The human readable source file is converted into an object file by the assembler. In the most basic form, the object file is converted into an executable file by the linker. The loader will load the executable file into memory.

²³ For more information, refer to: <http://en.wikipedia.org/wiki/Toolchain>

An overview of the process is provided in the following diagram.

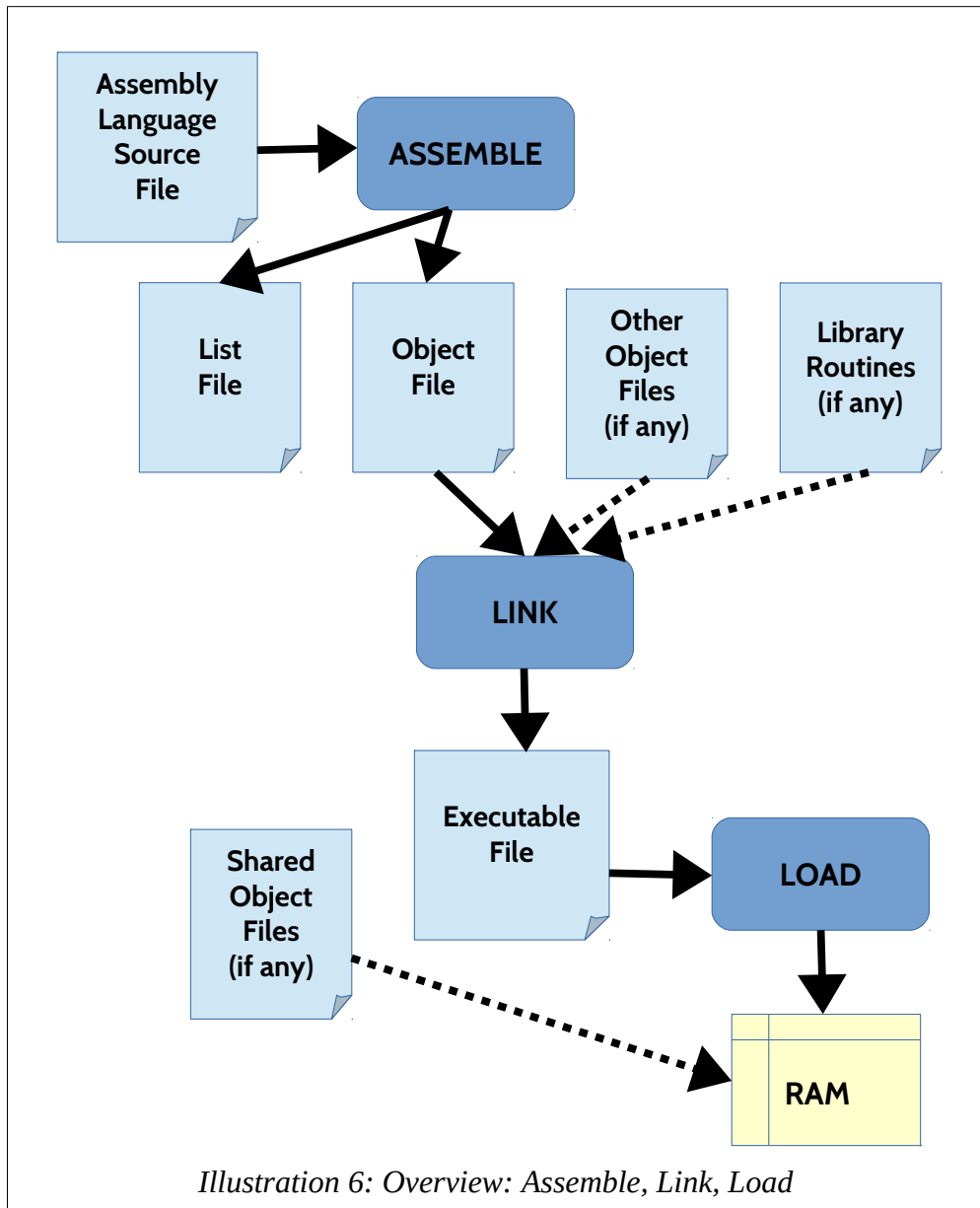

The assemble, link, and load steps are described in more detail in the following sections.

5.2 Assembler

The assembler²⁴ is a program that will read an assembly language input file and convert the code into a machine language binary file. The input file is an assembly language source file containing assembly language instructions in human readable form. The machine language output is referred to as an object file. As part of this process, the comments are removed, and the variable names and labels are converted into appropriate addresses (as required by the CPU during execution).

The assembler used in this text is the **yasm**²⁵ assembler. Links to the **yasm** web site and documentation can be found in Chapter 1, Introduction

5.2.1 Assemble Commands

The appropriate **yasm** assembler command for reading the assembly language source file, such as the example from the previous chapter, is as follows:

```
yasm -g dwarf2 -f elf64 example.asm -l example.lst
```

Note, the **-l** is a dash lower-case letter L (which is easily confused with the number 1).

The **-g dwarf2**²⁶ option is used to inform the assembler to include debugging information in the final object file. This increases the size of the object file, but is necessary to allow effective debugging. The **-f elf64** informs the assembler to create the object file in the **ELF64**²⁷ format which is appropriate for 64-bit, Linux based systems. The **example.asm** is the name of the assembly language source file for input. The **-l example.lst** (dash lower-case letter L) informs the assembler to create a list file named *example.lst*.

If an error occurs during the assembly process, it must be resolved before continuing to the link step.

5.2.2 List File

In addition, the assembler is optionally capable of creating a list file. The list file shows the line number, the relative address, the machine language version of the instruction (including variable references), and the original source line. The list file can be useful when debugging.

24 For more information, refer to: [http://en.wikipedia.org/wiki/Assembler_\(computing\)#Assembler](http://en.wikipedia.org/wiki/Assembler_(computing)#Assembler)

25 For more information, refer to: <https://en.wikipedia.org/wiki/Yasm>

26 For more information, refer to: <https://en.wikipedia.org/wiki/DWARF>

27 For more information, refer to: http://en.wikipedia.org/wiki/Executable_and_Linkable_Format

For example, a fragment from the list file data section, from the example program in the previous chapter is as follows:

```

36 00000009 40660301          dVar1    dd    17000000
37 0000000D 40548900          dVar2    dd    9000000
38 00000011 00000000          dResult  dd    0
    
```

On the first line, the **36** is the line number. The next number, **0x00000009**, is the relative address in the data area of where that variable will be stored. Since *dVar1* is a double-word, which requires four bytes, the address for the next variable is **0x0000000D**. The *dVar1* variable uses 4 bytes as addresses **0x00000009**, **0x0000000A**, **0x0000000B**, and **0x0000000C**. The rest of the line is the data declaration as typed in the original assembly language source file.

The **0x40660301** is the value, in hex, as placed in memory. The 17,000,000₁₀ is **0x01036640**. Recalling that the architecture is little-endian, the least significant byte (**0x40**) is placed in the lowest memory address. As such, the 0x40 is placed in relative address **0x00000009**, the next byte, **0x66**, is placed in address **0x0000000A** and so forth. This can be confusing as at first glance the number may appear backwards or garbled (depending on how it is viewed).

To help visualize, the memory picture would be as follows:

| variable name | value | address |
|---------------|-------|------------|
| | 00 | 0x00000010 |
| | 89 | 0x0000000F |
| | 54 | 0x0000000E |
| dVar2 → | 40 | 0x0000000D |
| | 01 | 0x0000000C |
| | 03 | 0x0000000B |
| | 66 | 0x0000000A |
| dVar1 → | 40 | 0x00000009 |

Illustration 7: Little-Endian, Multiple Variable Data Layout

For example, a fragment of the list file text section, excerpted from the example program in the previous chapter is as follows:

```

95                                     last:
96 0000005A 48C7C03C000000          mov     rax, SYS_exit
97 00000061 48C7C300000000          mov     rdi, EXIT_SUCCESS
98 00000068 0F05                      syscall

```

Again, the numbers to the left are the line numbers. The next number, **0x0000005A**, is the relative address of where the line of code will be placed.

The next number, **0x48C7C03C000000**, is the machine language version of the instruction, in hex, that the CPU reads and understands. The rest of the line is the original assembly language source instruction.

The label, **last:**, does not have a machine language instruction since the label is used to reference a specific address and is not an executable instruction.

5.2.3 Two-Pass Assembler

The assembler²⁸ will read the source file and convert each assembly language instruction, typed by the programmer, into a set of 1's and 0's that the CPU knows to be that instruction. The 1's and 0's are referred to as machine language. There is a one-to-one correspondence between the assembly language instructions and the binary machine language. This relationship means that machine language, in the form of an executable file can be converted back into human readable assembly language. Of course, the comments, variable names, and label names are missing, so the resulting code can be very difficult to read.

As the assembler reads each line of assembly language, it generates machine code for that instruction. This will work well for instructions that do not perform jumps. However, for instructions that might change the control flow (e.g., IF statements, unconditional jumps), the assembler is not able to convert the instruction. For example, given the following code fragment:

```

        mov     rax, 0
        jmp     skipRest
        ...
        ...
skipRest:

```

28 For more information, refer to: http://en.wikipedia.org/wiki/Assembly_language#Assembler

This is referred to as a forward reference. If the assembler reads the assembly file one line at a time, it has not read the line where *skipRest* is defined. In fact, it does not even know for sure if *skipRest* is defined at all.

This situation can be resolved by reading the assembly source file twice. The entire process is referred to as a two-pass assembler. The steps required for each pass are detailed in the following sections.

5.2.3.1 First Pass

The steps taken on the first pass vary based on the design of the specific assembler. However, some of the basic operations performed on the first pass include the following:

- Create symbol table
- Expand macros
- Evaluate constant expressions

A macro is a program element that is expanded into a set of programmer predefined instructions. For more information, refer to Chapter 11, Macros.

A constant expression is an expression composed entirely of constants. Since the expression is constants only, it can be fully evaluated at assemble time. For example, assuming the constant `BUFF` is defined, the following instruction contains a constant expression;

```
mov    rax, BUFF+5
```

This type of constant expression is used commonly in large or complex programs.

Addresses are assigned to all statements in the program. The symbol table is a listing or table of all the program symbols, variable names and program labels, and their respective addresses in the program.

As appropriate, some assembler directives are processed in the first pass.

5.2.3.2 Second Pass

The steps taken on the second pass vary based on the design of the specific assembler. However, some of the basic operations performed on the second pass include the following:

- Final generation of code
- Creation of list file (if requested)
- Create object file

The term code generation refers to the conversion of the programmer provided assembly language instruction into the CPU executable machine language instruction. Due to the one-to-one correspondence, this can be done for instructions that do not use symbols on either the first or second pass.

It should be noted that, based on the assembler design, much of the code generation might be done on the first pass or all done on the second pass. Either way, the final generation is performed on the second pass. This will require using the symbol table to check program symbols and obtain the appropriate addresses from the table.

The list file, while optional, can be useful for debugging. If requested, it would be generated on the second pass.

If there are no errors, the final object file is created on the second pass.

5.2.4 Assembler Directives

Assembler directives are instructions to the assembler that direct the assembler to do something. This might be formatting or layout. These directives are not translated into instructions for the CPU.

5.3 Linker

The linker²⁹, sometimes referred to as linkage editor, will combine one or more object files into a single executable file. Additionally, any routines from user or system libraries are included as necessary. The GNU gold linker, **ld**³⁰, is used. The appropriate linker command for the example program from the previous chapter is as follows:

```
ld -g -o example example.o
```

Note, the **-o** is a dash lower-case letter O, which is can be confused with the number 0.

The **-g** option is used to inform the linker to include debugging information in the final executable file. This increases the size of the executable file, but is necessary to allow effective debugging. The **-o example** specifies to create the executable file named *example* (with no extension). If the **-o <fileName>** option is omitted, the output file is

²⁹ For more information, refer to: [http://en.wikipedia.org/wiki/Linker_\(computing\)](http://en.wikipedia.org/wiki/Linker_(computing))

³⁰ For more information, refer to: [http://en.wikipedia.org/wiki/Gold_\(linker\)](http://en.wikipedia.org/wiki/Gold_(linker))

named *a.out* (by default). The *example.o* is the name of the input object file read by the linker. It should be noted that the executable file could be named anything and does not need to have the same name as any of the input object files.

5.3.1 Linking Multiple Files

In programming, large problems are typically solved by breaking them into smaller problems. The smaller problems can be addressed individually, possibly by different programmers.

Additional input object files, if any, would be listed, in order, separated with a space. For example, if there are two object files, *main.o* and *funcs.o* the link command to create an executable file name *example*, with debugging information included, would be as follows:

```
ld -g -o example main.o funcs.o
```

This would typically be required for larger or more complex programs.

When using functions located in a different, external source file, any function or functions not in the current source file must be declared as **extern**. Variables, such as global variables, in other source files can be accessed by using the `extern` statement as well, however data is typically transferred as arguments of the function call.

5.3.2 Linking Process

Linking is the fundamental process of combining the smaller solutions into a single executable unit. If any user or system library routines are used, the linker will include the appropriate routines. The object files and library routines are combined into a single executable module. The machine language code is copied from each object file into a single executable.

As part of combining the object files, the linker must adjust the relocatable addresses as necessary. Assuming there are two source files, the main and a secondary source file containing some functions, both of which have been assembled into object files *main.o* and *funcs.o*. When each file is assembled, the calls to routines outside the file being assembled are declared with the external assembler directive. The code is not available for an external reference and such references are marked as external in the object file. The list file will show an **R** for such relocatable addresses. The linker must satisfy the external references. Additionally, the final location of the external references must be placed in the code.

For example, if the *main.o* object file calls a function in the *funcs.o* file, the linker must update the call with the appropriate address as shown in the following illustration.

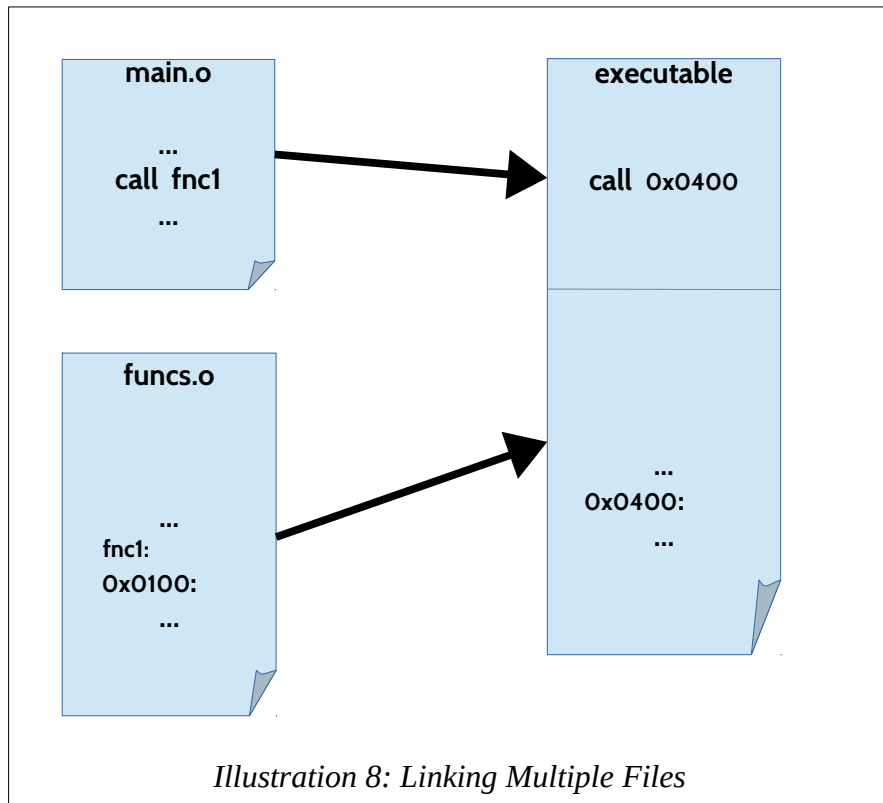

Here, the function *fnc1* is external to the *main.o* object file and is marked with an R. The actual function *fnc1* is in the *funcs.o* file, which starts its relative addressing from 0x0 (in the text section) since it does not know about the main code. When the object files are combined, the original relative address of *fnc1* (shown as 0x0100:) is changed to its final address in executable file (shown as 0x0400:). The linker must insert this final address into the call statement in the main (shown as call 0x0400:) in order to complete the linking process and ensure the function call will work correctly.

This will occur with all relocatable addresses for both code and data.

5.3.3 Dynamic Linking

The Linux operating system supports dynamic linking³¹, which allows for postponing the resolution of some symbols until a program is being executed. The actual instructions are not placed in executable file and instead, if needed, resolved and accessed at run-time.

While more complex, this approach offers two advantages:

- Often-used libraries (for example the standard system libraries) can be stored in only one location, not duplicated in every single binary.
- If a bug in a library function is corrected, all programs using it dynamically will benefit from the correction (at the next execution). Otherwise, programs that utilize this function by static linking would have to be re-linked before the correction is applied.

There are also disadvantages:

- An incompatible updated library will break executables that depended on the behavior of the previous version of the library.
- A program, together with the libraries it uses, might be certified (e.g. as to correctness, documentation requirements, or performance) as a package, but not if components can be replaced.

In Linux/Unix, the dynamically linked object files typically have a `.so` (shared object) extension. In Windows, they have a `.dll` (dynamically linked library) extension. Further details of dynamic linking are outside the scope of this text.

5.4 Assemble/Link Script

When programming, it is often necessary to type the assemble and link commands many times with various different programs. Instead of typing the assemble (**yasm**) and link (**ld**) commands each time, it is possible to place them in a file, called a script file. Then, the script file can be executed which will just execute the commands that were entered in the file. While not required, using a script file can save time and make things easier when working on a program.

31 For more information, refer to: http://en.wikipedia.org/wiki/Dynamic_linker

A simple example bash³² assemble/link script is as follows:

```
#!/bin/bash
# Simple assemble/link script.

if [ -z $1 ]; then
    echo "Usage: ./asm64 <asmMainFile> (no extension)"
    exit
fi

# Verify no extensions were entered

if [ ! -e "$1.asm" ]; then
    echo "Error, $1.asm not found."
    echo "Note, do not enter file extensions."
    exit
fi

# Compile, assemble, and link.

yasm -Worphan-labels -g dwarf2 -f elf64 $1.asm -l $1.lst
ld -g -o $1 $1.o
```

The above script should be placed in a file. For this example, the file will be named *asm64* and placed in the current working directory (where the source files are located).

Once created, execute privilege will need to be added to the script file as follows:

```
chmod +x asm64
```

This will only need to be done once for each script file.

The script file will read the source file name from the command line. For example, to use the script file to assemble the example from the previous chapter (named *example.asm*), type the following:

```
./asm64 example
```

The ".asm" extension on the *example.asm* file should not be included (since it is added in the script). The script file will assemble and link the source file, creating the list file, object file, and executable file.

32 For more information, refer to: [http://en.wikipedia.org/wiki/Bash_\(Unix_shell\)](http://en.wikipedia.org/wiki/Bash_(Unix_shell))

Use of this, or any script file, is optional. The name of the script file can be changed as desired.

5.5 Loader

The loader³³ is a part of the operating-system that will load the program from secondary storage into primary storage (i.e., main memory). In broad terms, the loader will attempt to find, and if found, read a properly formatted executable file, create a new process, and load the code into memory and mark the program as ready for execution. The operating-system scheduler will make the decisions about which process is executed and when the process is executed.

The loader is implicitly invoked by typing the program name. For example, on the previous example program, named *example*, the Linux command would be:

```
./example
```

which will execute the file named *example* created via the previous steps (assemble and link). Since the example program does not perform any output, nothing will be displayed to the console. As such, a debugger can be used to check the results.

5.6 Debugger

The debugger³⁴ is used to control execution of a program. This allows for testing and debugging activities to be performed.

In the previous example, the program computed a series of calculations, but did not output any of the results. The debugger can be used to check the results. The executable file is created with the assemble and link command previously described and must include the -g option.

The debugger used is the GNU DDD debugger which provides a visual front-end for the GNU command line debugger, **gdb**. The DDD web site and documentation are noted in the references section of Chapter 1, Introduction.

The **ddd** debugger is started with the executable file. For example, using the previous sample program, *example*, the command would be:

```
ddd example
```

33 For more information, refer to: [http://en.wikipedia.org/wiki/Loader_\(computing\)](http://en.wikipedia.org/wiki/Loader_(computing))

34 For more information, refer to: <http://en.wikipedia.org/wiki/Debugger>

Due to the complexity and importance of the debugger, a separate chapter for the debugging is provided.

5.7 Exercises

Below are some questions based on this chapter.

5.7.1 Quiz Questions

Below are some quiz questions.

- 1) What is the relationship between assembly language and machine language?
- 2) What actions are performed on the first-pass of the assembler?
- 3) What actions are performed on the second-pass of the assembler?
- 4) What actions are performed by the linker?
- 5) What actions are performed by the loader?
- 6) Provide an example of a *constant expression*.
- 7) Draw a diagram of the entire assemble, link, and load process.
- 8) When is a shared object file linked with a program?
- 9) What is contained in the symbol table (two things)?

My software never has bugs. It just develops random features.

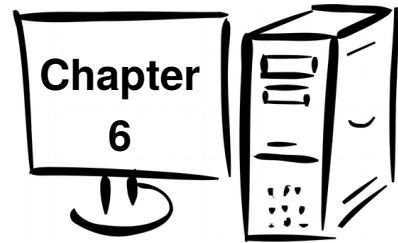

6.0 DDD Debugger

A debugger allows the user to control execution of a program, examine variables, other memory (i.e., stack space), and display program output (if any). The open source GNU Data Display Debugger (DDD³⁵) is a visual front-end to the GNU Debugger (GDB³⁶) debugger and is widely available. Other debuggers can easily be used if desired.

Only the basic debugger commands are addressed in this chapter. The DDD debugger has many more features and options not covered here. As you gain experience, it would be worth reviewing the DDD documentation, referenced in Chapter 1, to learn more about additional features in order to help improve overall debugging efficiency.

DDD functionality can be extended using various plug-ins. The plug-ins are not required and will not be addressed in this Chapter.

This chapter addresses using the GNU DDD debugger as a tool. The logical process of how to debug a program is not addressed in this chapter.

6.1 Starting DDD

The **ddd** debugger is started with the executable file. The program must be assembled and linked with the correct options (as noted in the previous chapter). For example, using the previous sample program, *example*, the command would be:

```
ddd example
```

Upon starting DDD/GDB, something similar to the screen, shown below, should be displayed (with the appropriate source code displayed).

35 For more information, refer to: http://en.wikipedia.org/wiki/Data_Display_Debugger

36 For more information, refer to: http://en.wikipedia.org/wiki/GNU_Debugger

Chapter 6.0 ◀ DDD Debugger

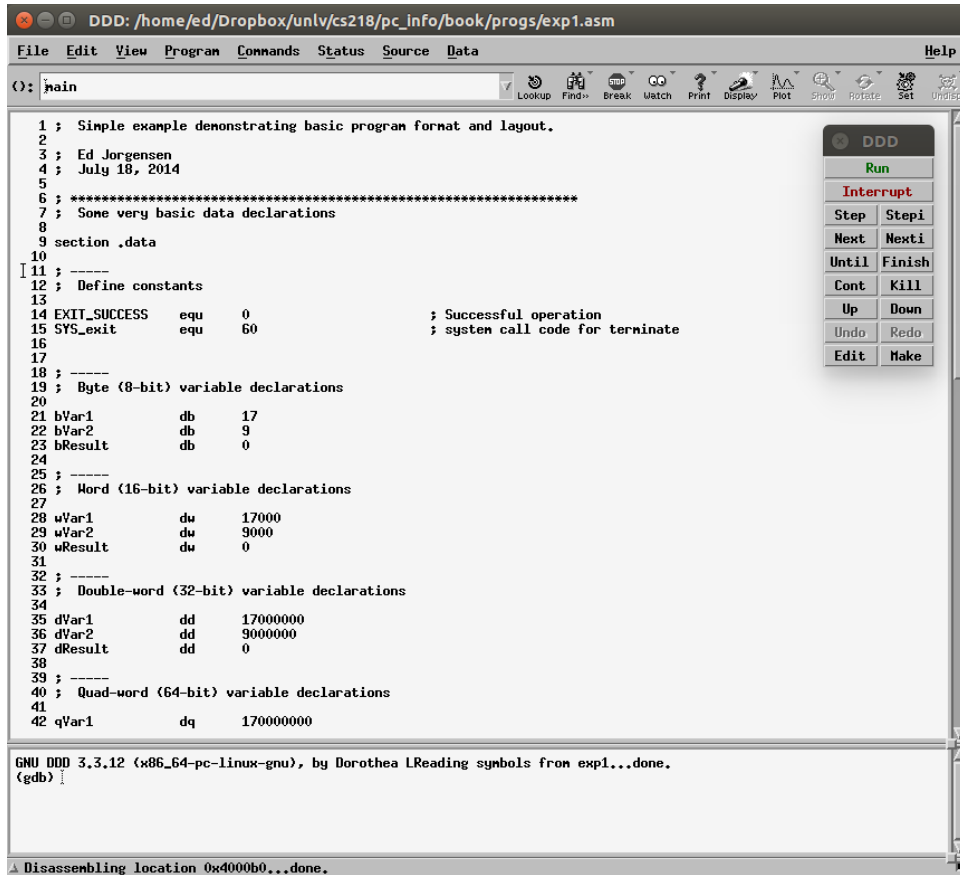

Illustration 9: Initial Debugger Screen

If the code is not displayed in a similar manner as shown above, the assemble and link steps should be verified. Specifically, the `-g` qualifier must be included in both the assemble and link steps.

Built in help is available by clicking on the Help menu item (upper right-hand corner). The DDD and GDB manuals are available from the virtual library link on the class web page. To exit DDD/GDB, select **File** → **Exit** (from the top menu bar).

6.1.1 DDD Configuration Settings

Some additional DDD/GDB configuration settings suggestions include:

Edit → Preferences → General → Suppress X Warning

Edit → Preferences → Source → Display Source Line Numbers

These are not required, but can make using the debugger easier. If set, the options will be saved and remembered for successive uses of the debugger (on the same machine).

6.2 Program Execution with DDD

To execute the program, click on the **Run** button from the command tool menu (shown below). Alternately, you can type **run** at the (gdb) prompt (bottom GDB console window). However, this will execute the program entirely and, when done, the results will be reset (and lost).

6.2.1 Setting Breakpoints

In order to control program execution, it will be necessary to set a breakpoint (execution pause location) to pause the program at a user selected location. This can be done by selecting the source location (line to stop at). For this example, we will stop at line 31.

The breakpoint can be done one of three ways:

- Right click on the line number and select: *Set Breakpoint*
- In the GDB Command Console, at the (gdb) prompt, type: **break last**
- In the GDB Command Console, at the (gdb) prompt, type: **break 31**

Chapter 6.0 ◀ DDD Debugger

When set correctly, the “stop” icon will appear to the left of line number (as shown in the diagram).

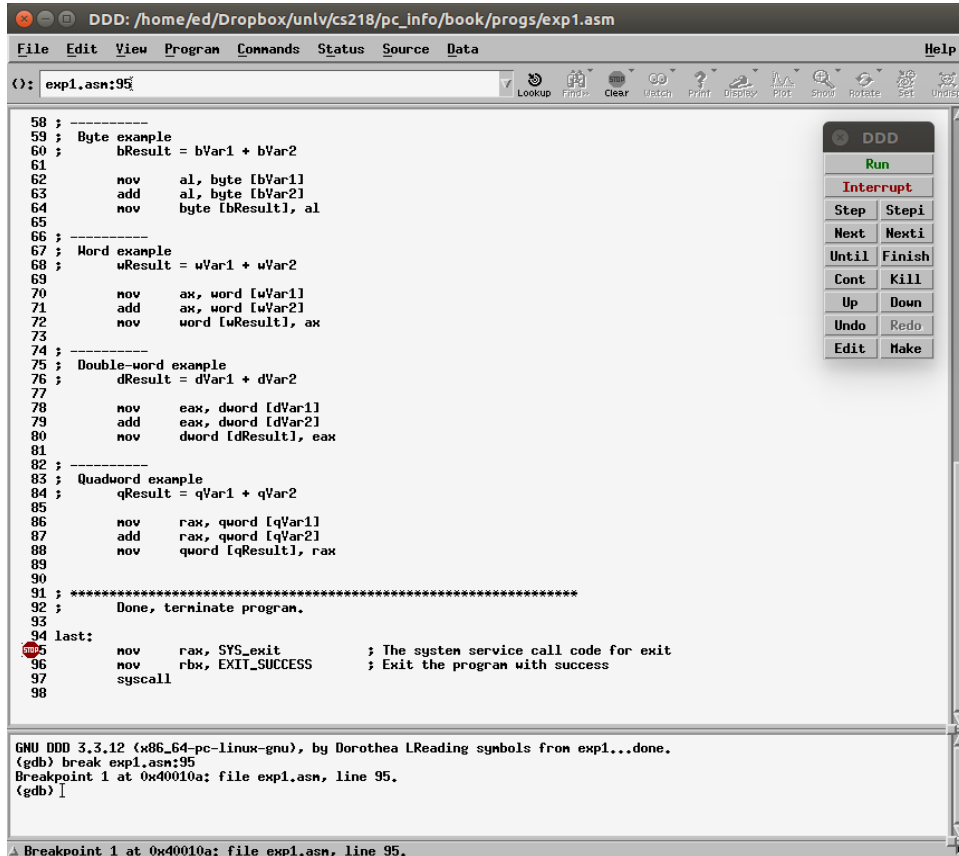

Illustration 10: Debugger Screen with Breakpoint Set

DDD/GDB commands can be typed inside the bottom window (at the **(gdb)** prompt) at any time. Multiple breakpoints can be set if desired.

6.2.2 Executing Programs

Once the debugger is started, in order to effectively use the debugger, an initial breakpoint must be set.

Once the breakpoint is set, the run command can be performed via clicking **Run** menu window or typing **run** at the (gdb) prompt. The program will execute up to, *but not including* the statement with the green arrow.

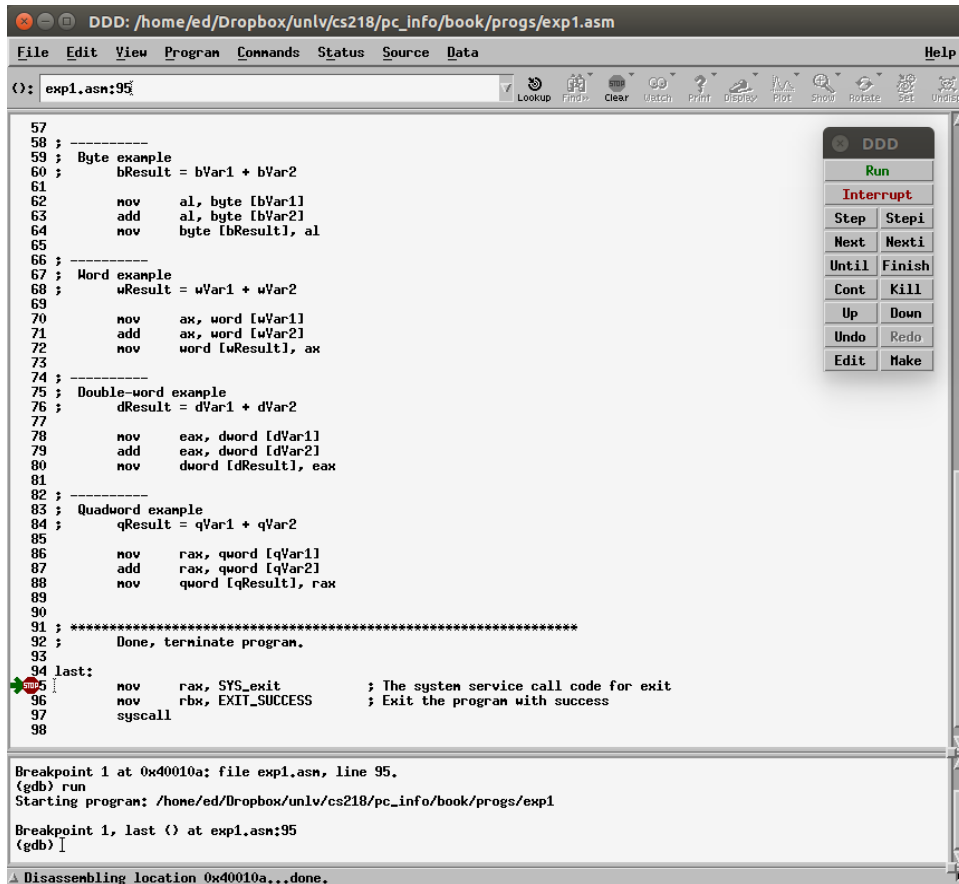

```

DDD: /home/ed/Dropbox/unlv/cs218/pc_info/book/progs/exp1.asm
File Edit View Program Commands Status Source Data Help
(): exp1.asm:95
57 ;
58 ;
59 ; Byte example
60 ; bResult = bVar1 + bVar2
61
62     mov     al, byte [bVar1]
63     add     al, byte [bVar2]
64     mov     byte [bResult], al
65 ;
66 ;
67 ; Word example
68 ; wResult = wVar1 + wVar2
69
70     mov     ax, word [wVar1]
71     add     ax, word [wVar2]
72     mov     word [wResult], ax
73 ;
74 ;
75 ; Double-word example
76 ; dResult = dVar1 + dVar2
77
78     mov     eax, dword [dVar1]
79     add     eax, dword [dVar2]
80     mov     dword [dResult], eax
81 ;
82 ;
83 ; Quadword example
84 ; qResult = qVar1 + qVar2
85
86     mov     rax, qword [qVar1]
87     add     rax, qword [qVar2]
88     mov     qword [qResult], rax
89 ;
90 ;
91 ; *****
92 ; Done, terminate program.
93 ;
94 last:
95     mov     rax, SYS_exit           ; The system service call code for exit
96     mov     rbx, EXIT_SUCCESS      ; Exit the program with success
97     syscall
98
Breakpoint 1 at 0x40010a: file exp1.asm, line 95.
(gdb) run
Starting program: /home/ed/Dropbox/unlv/cs218/pc_info/book/progs/exp1
Breakpoint 1, last () at exp1.asm:95
(gdb) |
Disassembling location 0x40010a...done.

```

Illustration 11: Debugger Screen with Green Arrow

The breakpoint is indicated with the stop sign on the right (see example previous page). The current location is indicated with a green arrow. Specifically, the green arrow points to the *next instruction to be executed*. That is, the statement pointed to by the green arrow has **not** yet been executed.

6.2.2.1 Run / Continue

As needed, additional breakpoints can be set. However, click the **Run** command will re-start execution from the beginning and stop at the initial breakpoint.



Illustration 12: DDD Command Bar

After the initial **Run** command, to continue to the next breakpoint, the continue command must be used (by clicking **Cont** menu window or typing **cont** at the (gdb) prompt). Single lines can also be executed one line at a time by typing the step or next commands (via clicking **Step** or **Next** menu window or typing **step** or **next** at the (gdb) prompt).

6.2.2.2 Next / Step

The **next** command will execute to the next instruction. This includes executing an entire function if necessary. The **step** command will execute one step, stepping into functions if necessary. For a single, non-function instruction, there is no difference between the **next** and **step** commands.

6.2.3 Displaying Register Contents

The simplest method to see the contents of the registers is to use the registers window. The registers window is not displayed by default, but can be viewed by selecting **Status** → **Registers** (from the top menu bar). When displayed, the register window will show register contents by register name (left column), in both hex (middle column) and signed decimal (right column).



Illustration 13: Register Window

Depending on the machine and screen resolution, the register window may need to be resized to view the entire contents.

The third column of the register window generally shows the decimal quadword representation except for some special purpose registers (**rbp** and **rsp**). The signed quadword decimal representation may not always be meaningful. For example, if unsigned data is being used (such as addresses), the signed representation would be incorrect. Additionally, when character data is used, the signed representation would not be meaningful.

By default, only the integer registers are displayed. Clicking on the “All registers” box will add the floating-point registers to the display. Viewing will require scrolling down within the register window.

6.2.4 DDD/GDB Commands Summary

The following table provides a small subset of the most common DDD commands. When typed, most commands may be abbreviated. For example, **quit** can be abbreviated as **q**. The command and the abbreviation are shown in the table.

| Command | Description |
|---|--|
| quit q | Quit the debugger. |
| break b <label/addr> | Set a break point (stop point) at <label> or <address>. |
| run <args> r <args> | Execute the program (to the first breakpoint). |
| continue c | Continue execution (to the next breakpoint). |
| step s | Step into next instruction (steps into procedure calls). |
| next n | Next instruction (steps through procedure calls). |
| F3 | Re-start program (and stop at first breakpoint). |
| where | Current activation (call depth). |
| x / <n> <f><u> \$rsp | Examine contents of the stack. |

| Command | Description |
|--|--|
| x/<n><f><u> &<variable> | Examine memory location <variable> <n> number of locations to display, 1 is default. <f> format: d – decimal (signed) x – hex u – decimal (unsigned) c – character s – string f – floating-point <u> unit size: b – byte (8-bits) h – halfword (16-bits) w – word (32-bits) g – giant (64-bits) |
| source <filename> | Read commands from file <filename>. |
| set logging file <filename> | Set logging file to <filename>, default is <i>gdb.txt</i> . |
| set logging on | Turn logging (to a file) on. |
| set logging off | Turn logging (to a file) off. |
| set logging overwrite | When logging (to a file) is turned on, overwrite previous log file (if any). |

More information can be obtained via the built-in help facility or from the documentation on the **ddd** website (referenced from Chapter 1).

6.2.4.1 DDD/GDB Commands, Examples

For example, given the below data declarations:

```
bnum1      db      5
wnum2      dw     -2000
dnum3      dd     100000
qnum       dq     1234567890
class      db     "Assembly", 0
twopi      dd     6.28
```

Assuming *signed data*, the commands to examine memory commands would be as follows:

```
x/db &bnum1
x/dh &wnum2
x/dw &dnum3
x/dg &qnum
x/s &class
x/f &twopi
```

If an inappropriate memory dump command is used (i.e., incorrect size), *there is no error message* and the debugger will display what was requested (even if it does not make sense). Examining variables will require use of the appropriate memory dump command based on the data declarations. Additional options can be accessed across the menu at the top of the screen.

To display an array in DDD, the basic examine memory command is used.

```
x/<n><f><u> &<variable>
```

For example, assuming the declaration of:

```
list1      dd     100001, -100002, 100003, 100004, 100005
```

The examine memory commands would be as follows:

```
x/5dw &list1
```

Where the 5 is the array length. The **d** indicates signed data (**u** would have been unsigned data). The **w** indicates 32-bit sized data (which is what the **dd**, define double, definition declares in the source file). The **&list1** refers to the address of the variable. *Note*, the address points to the first element (and only the first element). As such, it is possible to display less or more elements that are actually declared in the array.

The basic examine memory command can be used with a memory address directly (as opposed to a variable name). For example:

```
x/dw 0x600d44
```

Addresses are typically displayed in hexadecimal, so a 0x would be required in order to enter the hexadecimal address directly as shown.

6.2.5 Displaying Stack Contents

There are some occasions when displaying the contents of the stack may be useful. The stack is normally comprised of 64-bit, unsigned elements. The examine memory command is used, however the address is in the **rsp** register (not a variable name). The examine memory command to display the current top of the stack would be as follows:

```
x/ug $rsp
```

The examine memory command to display the top 6 items on the stack would be as follows:

```
x/6ug $rsp
```

Due to the stack implementation, the first item shown will always be current top of the stack.

6.2.6 Debugger Commands File (interactive)

Since the data display commands must be correct (since there is no error), it can be tedious. To help reduce errors, the correct execution and display command can be stored in a text file. The debugger can then read the commands from the file (instead of typing them by hand). While the results are typically displayed to the screen, the results can be re-directed to an output file. This can be useful for easy review.

For example, some typical debugger commands to set the breakpoint, run the program, display some variables, and redirect the output to a log file might be as follows:

```
#-----  
#  Debugger Input Script  
#-----  
echo \n\n  
break last  
run  
set pagination off
```

```
set logging file out.txt
set logging overwrite
set logging on
set prompt
echo ----- \n
echo display variables \n
echo \n
x/100dw &list
x/dw &length
echo \n
x/dw &listMin
x/dw &listMid
x/dw &listMax
x/dw &listSum
x/dw &listAve
echo \n \n
set logging off
quit
```

Note 1; this example assumes a label **'last'** is defined in the source program (as is done on the example program).

Note 2; this example exits the debugger. If that is not desired, the **'quit'** command can be removed. When exiting from the input file, the debugger may request user confirmation of the exit (yes or no).

These commands should be placed in a file (such as *gdbIn.txt*), so they can be read from within the debugger.

6.2.6.1 Debugger Commands File (non-interactive)

The debugger command to read a file is "source <filename>". For example, if the command file is named *gdbIn.txt*,

```
(gdb) source gdbIn.txt
```

Based on the above commands, the output will be placed in the file *out.txt*. The output file name can be changed as desired.

Each program will require a custom input command set based on the variables and associated sizes. The debugger input commands file will only be useful when the program is fairly close to working. Program crashes and other more significant errors will require interactive debugging to determine the specific error.

6.2.6.2 Debugger Commands File (non-interactive)

It is possible to obtain the output file directly without an interactive DDD session. The following command, entered at the command line, will execute the command in the input file on the given program, create the output file, and exit the program.

```
gbd <gdbIn.txt prog
```

Which will create the output file (as specified in the *gdbIn.txt* file) and exit the debugger. This is the fastest option for obtaining the final output file for a working program. Again, this would only be useful if the program is working or very close to working correctly.

6.3 Exercises

Below are some quiz questions based on this chapter.

6.3.1 Quiz Questions

Below are some quiz questions.

- 1) How is the debugger started (from the command line)?
- 2) What option is required during the assemble and link step in order to ensure the program be easily debugged.
- 3) What does the **run** command do specifically?
- 4) What does the **continue** command do specifically?
- 5) How is the register window displayed?
- 6) There are three columns in the register window. The first shows the register. What do the other two columns show?
- 7) Once the debugger is started, how can the user exit?
- 8) Describe how a breakpoint is set (multiple ways).
- 9) What is the debugger command to read debugger commands from a file?
- 10) When the DDD shows a green arrow pointing to an instruction, what does that mean?

- 11) Provide the debugger command to display each of the following variables in decimal.
 1. **bVar1** (byte sized variable)
 2. **wVar1** (word sized variable)
 3. **dVar1** (double-word sized variable)
 4. **qVar1** (quadword sized variable)
 5. **bArr1** (30 element array of bytes)
 6. **wArr1** (50 element array of words)
 7. **dArr1** (75 element array of double-words)
- 12) Provide the debugger command to display each of the following variables in hexadecimal format.
 1. **bVar1** (byte sized variable)
 2. **wVar1** (word sized variable)
 3. **dVar1** (double-word sized variable)
 4. **qVar1** (quadword sized variable)
 5. **bArr1** (30 element array of bytes)
 6. **wArr1** (50 element array of words)
 7. **dArr1** (75 element array of double-words)
- 13) What is the debugger command to display the value at the current top of the stack?
- 14) What is the debugger command to display five (5) values at the current top of the stack?

6.3.2 Suggested Projects

Below are some suggested projects based on this chapter.

- 1) Type in the example program from Chapter 4, Program Format. Assemble and link the program as described in Chapter 5, Tool Chain. Execute the debugger as noted in this chapter. Set a breakpoint at the label last and execute the program (to that breakpoint). Interactively verify that the calculations performed resulted

in the correct values. This will require typing the appropriate debugger examine memory commands (based on the variable size).

- 2) After completing the previous problem, create a debugger input file that will set the send the output to a text file, set a breakpoint, execute the program, and display the results for each variable (based on the appropriate variable size). Execute the debugger and read the source file. Review the input file worked correctly and that the program calculations are correct based on the results shown in the output file.
- 3) Create an assemble and link script file, as described in Chapter 5, Tool Chain. Use the script to assemble and link the program. Ensure that the script correctly assembles and links.

*Why are math books sad?
Because they have so many problems.*

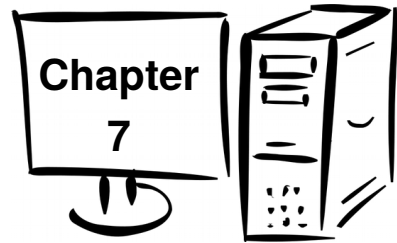

7.0 Instruction Set Overview

This chapter provides a basic overview for a simple subset of the x86-64 instruction set focusing on the integer operations. This will cover the only the subset of instructions required for the topics and programs discussed within the scope of this text. This will exclude some of the more advanced instructions and restricted mode instructions. For a complete listing of all processor instructions, refer to the references listed in Chapter 1.

The instructions are presented in the following order:

- Data Movement
- Conversion Instructions
- Arithmetic Instructions
- Logical Instructions
- Control Instructions

The instructions for function calls are discussed in the chapter in Chapter 12, Functions.

A complete listing of the instructions covered in this text is located in Appendix B for reference.

7.1 Notational Conventions

This section summarizes the notation used within this text which is fairly common in the technical literature. In general, an instruction will consist of the instruction or operation itself (i.e., add, sub, mul, etc.) and the **operands**. The operands refer to where the data (to be operated on) is coming from and/or where the result is to be placed.

7.1.1 Operand Notation

The following table summarizes the notational conventions used in the remainder of the document.

| Operand Notation | Description |
|--|--|
| <reg> | Register operand. The operand must be a register. |
| <reg8>, <reg16>, <reg32>, <reg64> | Register operand with specific size requirement. For example, reg8 means a byte sized register (e.g., al , bl , etc.) only and reg32 means a double-word sized register (e.g., eax , ebx , etc.) only. |
| <dest> | Destination operand. The operand may be a register or memory. Since it is a destination operand, the contents will be overwritten with the new result (based on the specific instruction). |
| <RXdest> | Floating-point destination register operand. The operand must be a floating-point register. Since it is a destination operand, the contents will be overwritten with the new result (based on the specific instruction). |
| <src> | Source operand. Operand value is unchanged after the instruction. |
| <imm> | Immediate value. May be specified in decimal, hex, octal, or binary. |
| <mem> | Memory location. May be a variable name or an indirect reference (i.e., a memory address). |
| <op> or <operand> | Operand, register or memory. |
| <op8>, <op16>, <op32>, <op64> | Operand, register or memory, with specific size requirement. For example, op8 means a byte sized operand only and reg32 means a double-word sized operand only. |
| <label> | Program label. |

By default, the immediate values are decimal or base-10. Hexadecimal or base-16 immediate values may be used but must be preceded with a **0x** to indicate the value is hex. For example, 15₁₀ could be entered in hex as **0x0F**.

Refer to Chapter 8, Addressing Modes for more information regarding memory locations and indirection.

7.2 Data Movement

Typically, data must be moved into a CPU register from RAM in order to be operated upon. Once the calculations are completed, the result may be copied from the register and placed into a variable. There are a number of simple formulas in the example program that perform these steps. This basic data movement operation is performed with the move instruction.

The general form of the move instruction is:

```
mov  <dest>, <src>
```

The source operand is copied from the source operand into the destination operand. The value of the source operand is unchanged. The destination and source operand must be of the same size (both bytes, both words, etc.). The destination operand cannot be an immediate. Both operands cannot be memory. If a memory to memory operation is required, two instructions must be used.

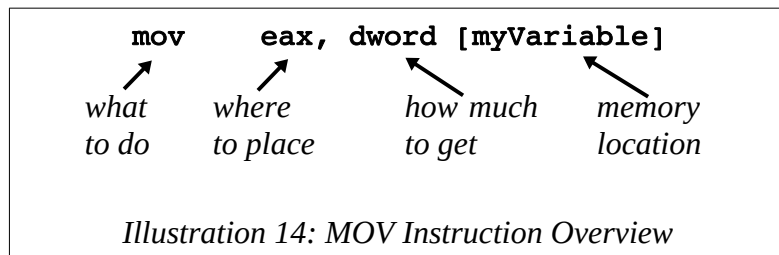

When the destination register operand is of double-word size and the source operand is of double-word size, the upper-order double-word of the quadword register is set to zero. This only applies when the destination operand is a double-word sized integer register.

Specifically, if the following operations are performed,

```
mov   eax, 100           ; eax = 0x00000064
mov   rcx, -1            ; rcx = 0xffffffffffffffff
mov   ecx, eax          ; ecx = 0x00000064
```

Initially, the **rcx** register is set to -1 (which is all 0xF's). When the positive number from the **eax** register (100₁₀) is moved into the **rcx** register, the upper-order portion of

the quadword register **rcx** is set to 0 over-writing the 1's from the previous instruction.

The move instruction is summarized as follows:

| Instruction | Explanation |
|--------------------------|---|
| mov <dest>, <src> | Copy source operand to the destination operand. <i>Note 1</i> , both operands cannot be memory. <i>Note 2</i> , destination operands cannot be an immediate. <i>Note 3</i> , for double-word destination and source operand, the upper-order portion of the quadword register is set to 0. |
| Examples: | <pre> mov ax, 42 mov cl, byte [bvar] mov dword [dVar], eax mov qword [qVar], rdx </pre> |

A more complete list of the instructions is located in Appendix B.

For example, assuming the following data declarations:

```

dValue    dd    0
bNum     db    42
wNum     dd    5000
dNum     dw    73000
qNum     dw    73000000
bAns     db    0
wAns     dw    0
dAns     dd    0
qAns     dd    0

```

To perform, the basic operations of:

```

dValue = 27
bAns   = bNum
wAns   = wNum
dAns   = dNum
qAns   = qNum

```

The following instructions could be used:

```

mov    dword [dValue], 27           ; dValue = 27

mov    al, byte [bNum]
mov    byte [bAns], al             ; bAns = bNum

mov    ax, word [wNum]
mov    word [wAns], ax            ; wAns = wNum

mov    eax, dword [dNum]
mov    dword [dAns], eax          ; dAns = dNum

mov    rax, qword [qNum]
mov    qword [qAns], rax         ; qAns = qNum

```

For some instructions, including those above, the explicit type specification (e.g., *byte*, *word*, *dword*, *qword*) can be omitted as the other operand will clearly define the size. In the text it will be included for consistency and good programming practice.

7.3 Addresses and Values

The only way to access memory is with the brackets ([]'s). Omitting the brackets will not access memory and instead obtain the address of the item. For example:

```

mov    rax, qword [var1]           ; value of var1 in rax
mov    rax, var1                  ; address of var1 in rax

```

Since omitting the brackets is not an error, the assembler will not generate error messages or warnings. This can lead to confusion.

In addition, the address of a variable can be obtained with the load effective address, or **lea**, instruction. The load effective address instruction is summarized as follows:

| Instruction | Explanation |
|---|---|
| <code>lea <reg64>, <mem></code> | Place address of <mem> into reg64 . |
| Examples: | <pre> lea rcx, byte [bvar] lea rsi, dword [dVar] </pre> |

A more complete list of the instructions is located in Appendix B.

Additional information and extensive examples are presented in Chapter 8, Addressing Modes.

7.4 Conversion Instructions

It is sometimes necessary to convert from one size to another size. For example, a byte might need to be converted to a double-word for some calculations in a formula. The process used for conversions depends on the size and type of the operand. The following sections summarize how conversions are performed.

7.4.1 Narrowing Conversions

Narrowing conversions are converting from a larger type to a smaller type (i.e., word to byte or double-word to word).

No special instructions are needed for narrowing conversions. The lower portion of the memory location or register may be accessed directly. For example, if the value of 50 (0x32) is placed in the **rax** register, the **al** register may be accessed directly to obtain the value as follows:

```
mov    rax, 50
mov    byte [bVal], al
```

This example is reasonable since the value of 50 will fit in a byte value. However, if the value of 500 (0x1f4) is placed in the **rax** register, the **al** register can still be accessed.

```
mov    rax, 500
mov    byte [bVal], al
```

In this example, the **bVal** variable will contain 0xf4 which may lead to incorrect results. The programmer is responsible for ensuring that narrowing conversions are performed appropriately. Unlike a compiler, no warnings or error messages will be generated.

7.4.2 Widening Conversions

Widening conversions are from a smaller type to a larger type (e.g., byte to word or word to double-word). Since the size is being expanded, the upper-order bits must be set based on the sign of the original value. As such, the data type, signed or unsigned, must be known and the appropriate process or instructions must be used.

7.4.2.1 Unsigned Conversions

For unsigned widening conversions, the upper part of the memory location or register must be set to zero. Since an unsigned value can only be positive, the upper-order bits can only be zero. For example, to convert the byte value of 50 in the **al** register, to a quadword value in **rbx**, the following operations can be performed.

```

mov     al, 50
mov     rbx, 0
mov     bl, al

```

Since the **rbx** register was set to 0 and then the lower 8-bits were set to the value from **al** (50 in this example), the entire 64-bit **rbx** register is now 50.

This general process can be performed on memory or other registers. It is the programmer's responsibility to ensure that the values are appropriate for the data sizes being used.

An unsigned conversion from a smaller size to a larger size can also be performed with a special move instruction, as follows:

```

movzx   <dest>, <src>

```

Which will fill the upper-order bits with zero. The **movzx** instruction does not allow a quadword destination operand with a double-word source operand. As previously noted, a **mov** instruction with a double-word register destination operand with a double-word source operand will zero the upper-order double-word of the quadword destination register.

A summary of the instructions that perform the unsigned widening conversion are as follows:

| Instruction | Explanation |
|------------------------------|---|
| movzx <dest>, <src> | Unsigned widening conversion. <i>Note 1</i> , both operands cannot be memory. <i>Note 2</i> , destination operands cannot be an immediate. <i>Note 3</i> , immediate values not allowed. |
| movzx <reg16>, <op8> | |
| movzx <reg32>, <op8> | |
| movzx <reg32>, <op16> | |
| movzx <reg64>, <op8> | |
| movzx <reg64>, <op16> | |
| Examples: | <pre> movzx cx, byte [bVar] movzx dx, al </pre> |

| | |
|--|---|
| | <pre> movzx ebx, word [wVar] movzx ebx, cx movzx rbx, cl movzx rbx, cx </pre> |
|--|---|

A more complete list of the instructions is located in Appendix B.

7.4.2.2 Signed Conversions

For signed widening conversions, the upper-order bits must be set to either 0's or 1's depending on if the original value was positive or negative.

This is performed by a sign-extend operation. Specifically, the upper-order bit of the original value indicates if the value is positive (with a 0) or negative (with a 1). The upper-order bit of the original value is extended into the higher bits of the new, widened value.

For example, given that the **ax** register is set to -7 (0xfff9), the bits would be set as follows:

| | | | | | | | | | | | | | | | |
|----|----|----|----|----|----|---|---|---|---|---|---|---|---|---|---|
| 15 | 14 | 13 | 12 | 11 | 10 | 9 | 8 | 7 | 6 | 5 | 4 | 3 | 2 | 1 | 0 |
| 1 | 1 | 1 | 1 | 1 | 1 | 1 | 1 | 1 | 1 | 1 | 1 | 1 | 0 | 0 | 1 |

Since the value is negative, the upper-order bit (bit 15) is a 1. To convert the word value in the **ax** register into a double-word value in the **eax** register, the upper order bit (1 in this example) is extended or copied into the entire upper-order word (bits 31-16) resulting in the following:

| | | | | | | | | | | | | | | | | | | | | | | | | | | | | | | | |
|----|----|----|----|----|----|----|----|----|----|----|----|----|----|----|----|----|----|----|----|----|----|---|---|---|---|---|---|---|---|---|---|
| 31 | 30 | 29 | 28 | 27 | 26 | 25 | 24 | 23 | 22 | 21 | 20 | 19 | 18 | 17 | 16 | 15 | 14 | 13 | 12 | 11 | 10 | 9 | 8 | 7 | 6 | 5 | 4 | 3 | 2 | 1 | 0 |
| 1 | 1 | 1 | 1 | 1 | 1 | 1 | 1 | 1 | 1 | 1 | 1 | 1 | 1 | 1 | 1 | 1 | 1 | 1 | 1 | 1 | 1 | 1 | 1 | 1 | 1 | 1 | 1 | 1 | 0 | 0 | 1 |

There are a series of dedicated instructions used to convert signed values in the **A** register from a smaller size into a larger size. These instructions work only on the **A** register, sometimes using the **D** register for the result. For example, the **cwd** instruction will convert a signed value in the **ax** register into a double-word value in the **dx** (upper order portion) and **ax** (lower order portion) registers. This is typically by convention written as **dx:ax**. The **cwde** instruction will convert a signed value in the **ax** register into a double-word value in the **eax** register.

A more generalized signed conversion from a smaller size to a larger size can also be performed with some special move instructions, as follows:

```

movsx    <dest>, <src>
movsxd  <dest>, <src>

```

Which will perform the sign extension operation on the source argument. The **movsx** instruction is the general form and the **movsxd** instruction is used to allow a quadword destination operand with a double-word source operand.

A summary of the instructions that perform the signed widening conversion are as follows:

| Instruction | Explanation |
|-------------|---|
| cbw | Convert byte in al into word in ax . <i>Note</i> , only works for al to ax register. |
| Examples: | cbw |
| cwd | Convert word in ax into double-word in dx:ax . <i>Note</i> , only works for ax to dx:ax registers. |
| Examples: | cwd |
| cwde | Convert word in ax into double-word in eax . <i>Note</i> , only works for ax to eax register. |
| Examples: | cwde |
| cdq | Convert double-word in eax into quadword in edx:eax . <i>Note</i> , only works for eax to edx:eax registers. |
| Examples: | cdq |
| cdqe | Convert double-word in eax into quadword in rax . <i>Note</i> , only works for rax register. |
| Examples: | cdqe |

| Instruction | Explanation |
|--|---|
| cqo | Convert quadword in rax into word in double-quadword in rdx:rax . <i>Note</i> , only works for rax to rdx:rax registers. |
| Examples: | cqo |
| movsx <dest>, <src> movsx <reg16>, <op8> movsx <reg32>, <op8> movsx <reg32>, <op16> movsx <reg64>, <op8> movsx <reg64>, <op16> movsxd <reg64>, <op32> | Signed widening conversion (via sign extension). <i>Note 1</i> , both operands cannot be memory. <i>Note 2</i> , destination operands cannot be an immediate. <i>Note 3</i> , immediate values not allowed. <i>Note 4</i> , special instruction (<i>movsxd</i>) required for 32-bit to 64-bit signed extension. |
| Examples: | movsx cx , byte [bVar] movsx dx , al movsx ebx , word [wVar] movsx ebx , cx movsxd rbx , dword [dVar] |

A more complete list of the instructions is located in Appendix B.

7.5 Integer Arithmetic Instructions

The integer arithmetic instructions perform arithmetic operations such as addition, subtraction, multiplication, and division on integer values. The following sections present the basic integer arithmetic operations.

7.5.1 Addition

The general form of the integer addition instruction is as follows:

```
add <dest>, <src>
```

Where operation performs the following:

```
<dest> = <dest> + <src>
```

Specifically, the source and destination operands are added and the result is placed in the destination operand (over-writing the previous contents). The value of the source operand is unchanged. The destination and source operand must be of the same size (both bytes, both words, etc.). The destination operand cannot be an immediate. Both operands, cannot be memory. If a memory to memory addition operation is required, two instructions must be used.

For example, assuming the following data declarations:

```

bNum1      db      42
bNum2      db      73
bAns       db      0

wNum1      dw      4321
wNum2      dw      1234
wAns       dw      0

dNum1      dd      42000
dNum2      dd      73000
dAns       dd      0

qNum1      dq      42000000
qNum2      dq      73000000
qAns       dq      0

```

To perform, the basic operations of:

```

bAns = bNum1 + bNum2
wAns = wNum1 + wNum2
dAns = dNum1 + dNum2
qAns = qNum1 + qNum2

```

The following instructions could be used:

```

; bAns = bNum1 + bNum2
mov   al, byte [bNum1]
add   al, byte [bNum2]
mov   byte [bAns], al

; wAns = wNum1 + wNum2
mov   ax, word [wNum1]
add   ax, word [wNum2]
mov   word [wAns], ax

```

```

; dAns = dNum1 + dNum2
mov     eax, dword [dNum1]
add     eax, dword [dNum2]
mov     dword [dAns], eax

; qAns = qNum1 + qNum2
mov     rax, qword [qNum1]
add     rax, qword [qNum2]
mov     qword [qAns], rax

```

For some instructions, including those above, the explicit type specification (e.g., *byte*, *word*, *dword*, *qword*) can be omitted as the other operand will clearly define the size. It is included for consistency and good programming practice.

In addition to the basic add instruction, there is an increment instruction that will add one to the specified operand. The general form of the increment instruction is as follows:

```
inc    <operand>
```

Where operation is as follows:

```
<operand> = <operand> + 1
```

The result is exactly the same as using the add instruction (and adding one). When using a memory operand, the explicit type specification (e.g., *byte*, *word*, *dword*, *qword*) is required to clearly define the size.

For example, assuming the following data declarations:

```

bNum      db      42
wNum      dw      4321
dNum      dd      42000
qNum      dq      42000000

```

To perform, the basic operations of:

```

rax = rax + 1
bNum = bNum + 1
wNum = wNum + 1
dNum = dNum + 1
qNum = qNum + 1

```

The following instructions could be used:

```
inc    rax                ; rax = rax + 1
inc    byte [bNum]       ; bNum = bNum + 1
inc    word [wNum]       ; wNum = wNum + 1
inc    dword [dNum]      ; dNum = dNum + 1
inc    qword [qNum]      ; qNum = qNum + 1
```

The addition instruction operates the same on signed and unsigned data. It is the programmer's responsibility to ensure that the data types and sizes are appropriate for the operations being performed.

The integer addition instructions are summarized as follows:

| Instruction | Explanation |
|--------------------------|--|
| add <dest>, <src> | Add two operands, (<dest> + <src>) and place the result in <dest> (over-writing previous value). <i>Note 1</i> , both operands cannot be memory. <i>Note 2</i> , destination operand cannot be an immediate. |
| Examples: | add cx, word [wVvar] add rax, 42 add dword [dVar], eax add qword [qVar], 300 |
| inc <operand> | Increment <operand> by 1. <i>Note</i> , <operand> cannot be an immediate. |
| Examples: | inc word [wVvar] inc rax inc dword [dVar] inc qword [qVar] |

A more complete list of the instructions is located in Appendix B.

7.5.1.1 Addition with Carry

The add with carry is a special add instruction that will include a carry from a previous addition operation. This is useful when adding very large numbers, specifically numbers larger than the register size of the machine.

Using a carry in addition is fairly standard. For example, consider the following operation.

$$\begin{array}{r} 17 \\ + 25 \\ ---- \\ 42 \end{array}$$

As you may recall, the least significant digits (7 and 5) are added first. The result of 12 is noted as a 2 with a 1 carry. The most significant digits (1 and 2) are added along with the previous carry (1 in this example) resulting in a 4.

As such, two addition operations are required. Since there is no carry possible with the least significant portion, a regular addition instruction is used. The second addition operation would need to include a possible carry from the previous operation and must be done with an add with carry instruction. Additionally, the add with carry must immediately follow the initial addition operation to ensure that the **rFlag** register is not altered by an unrelated instruction (thus possibly altering the carry bit).

For assembly language programs the Least Significant Quadword (LSQ) is added with the **add** instruction and then immediately the Most Significant Quadword (MSQ) is added with the **adc** which will add the quadwords and include a carry from the previous addition operation.

The general form of the integer add with carry instruction is as follows:

```
adc <dest>, <src>
```

Where operation performs the following:

```
<dest> = <dest> + <src> + <carryBit>
```

Specifically, the source and destination operands along with the carry bit are added and the result is placed in the destination operand (over-writing the previous value). The carry bit is part of the **rFlag** register. The value of the source operand is unchanged. The destination and source operand must be of the same size (both bytes, both words, etc.). The destination operand cannot be an immediate. Both operands, cannot be memory. If a memory to memory addition operation is required, two instructions must be used.

For example, given the following declarations;

```

dquad1    ddq    0x1A0000000000000000
dquad2    ddq    0x2C0000000000000000
dqSum     ddq    0

```

Each of the variables *dquad1*, *dquad2*, and *dqSum* are 128-bits and thus will exceed the machine 64-bit register size. However, two 64-bit registers can be used for each of the 128-bit values. This requires two move instructions, one for each 64-bit register. For example,

```

mov      rax, qword [dquad1]
mov      rdx, qword [dquad1+8]

```

The first move to the **rax** register accesses the first 64-bits of the 128-bit variable. The second move to the **rdx** register access the next 64-bits of the 128-bit variable. This is accomplished by using the variable starting address, *dquad1* and adding 8 bytes, thus skipping the first 64-bits (or 8 bytes) and accessing the next 64-bits.

If the LSQ's are added and then the MSQ's are added including any carry, the 128-bit result can be correctly obtained. For example,

```

mov      rax, qword [dquad1]
mov      rdx, qword [dquad1+8]

add      rax, qword [dquad2]
adc      rdx, qword [dquad2+8]

mov      qword [dqsum], rax
mov      qword [dqsum+8], rdx

```

Initially, the LSQ of *dquad1* is placed in **rax** and the MSQ is placed in **rdx**. Then the **add** instruction will add the 64-bit **rax** with the LSQ of *dquad2* and, in this example, provide a carry of 1 with the result in **rax**. Then the **rdx** is added with the MSQ of *dquad2* along with the carry via the **adc** instruction and the result placed in **rdx**.

The integer add with carry instruction is summarized as follows:

| Instruction | Explanation |
|--------------------------|--|
| adc <dest>, <src> | Add two operands, (<dest> + <src>) and any previous carry (stored in the carry bit in the rFlag register) and place the result in <dest> (over-writing previous value). <i>Note 1</i> , both operands cannot be memory. <i>Note 2</i> , destination operand cannot be an immediate. |
| Examples: | adc rcx, qword [dVvar1] adc rax, 42 |

A more complete list of the instructions is located in Appendix B.

7.5.2 Subtraction

The general form of the integer subtraction instruction is as follows:

```
sub <dest>, <src>
```

Where operation performs the following:

```
<dest> = <dest> - <src>
```

Specifically, the source operand is subtracted from the destination operand and the result is placed in the destination operand (over-writing the previous value). The value of the source operand is unchanged. The destination and source operand must be of the same size (both bytes, both words, etc.). The destination operand cannot be an immediate. Both operands, cannot be memory. If a memory to memory subtraction operation is required, two instructions must be used.

For example, assuming the following data declarations:

```
bNum1    db    73
bNum2    db    42
bAns     db    0

wNum1    dw    1234
wNum2    dw    4321
wAns     dw    0
```

| | | |
|--------------|-----------|-----------------|
| dNum1 | dd | 73000 |
| dNum2 | dd | 42000 |
| dAns | dd | 0 |
| | | |
| qNum1 | dq | 73000000 |
| qNum2 | dq | 73000000 |
| qAns | dd | 0 |

To perform, the basic operations of:

```

bAns = bNum1 - bNum2
wAns = wNum1 - wNum2
dAns = dNum1 - dNum2
qAns = qNum1 - qNum2

```

The following instructions could be used:

```

; bAns = bNum1 - bNum2
mov    al, byte [bNum1]
sub    al, byte [bNum2]
mov    byte [bAns], al

; wAns = wNum1 - wNum2
mov    ax, word [wNum1]
sub    ax, word [wNum2]
mov    word [wAns], ax

; dAns = dNum1 - dNum2
mov    eax, dword [dNum1]
sub    eax, dword [dNum2]
mov    dword [dAns], eax

; qAns = qNum1 - qNum2
mov    rax, qword [qNum1]
sub    rax, qword [qNum2]
mov    qword [qAns], rax

```

For some instructions, including those above, the explicit type specification (e.g., *byte*, *word*, *dword*, *qword*) can be omitted as the other operand will clearly define the size. It is included for consistency and good programming practices.

In addition to the basic subtract instruction, there is a decrement instruction that will subtract one from the specified operand. The general form of the decrement instruction is as follows:

```
dec    <operand>
```

Where operation performs the following:

```
<operand> = <operand> - 1
```

The result is exactly the same as using the subtract instruction (and subtracting one). When using a memory operand, the explicit type specification (e.g., *byte*, *word*, *dword*, *qword*) is required to clearly define the size.

For example, assuming the following data declarations:

```
bNum    db    42
wNum    dw    4321
dNum    dd    42000
qNum    dq    42000000
```

To perform, the basic operations of:

```
rax = rax - 1
bNum = bNum - 1
wNum = wNum - 1
dNum = dNum - 1
qNum = qNum - 1
```

The following instructions could be used:

```
dec    rax                ; rax = rax - 1
dec    byte [bNum]       ; bNum = bNum - 1
dec    word [wNum]       ; wNum = wNum - 1
dec    dword [dNum]      ; dNum = dNum - 1
dec    qword [qNum]     ; qNum = qNum - 1
```

The subtraction instructions operate the same on signed and unsigned data. It is the programmer's responsibility to ensure that the data types and sizes are appropriate for the operations being performed.

The integer subtraction instructions are summarized as follows:

| Instruction | Explanation |
|--------------------------|--|
| sub <dest>, <src> | Add two operands, (<dest> - <src>) and place the result in <dest> (over-writing previous value). <i>Note 1</i> , both operands cannot be memory. <i>Note 2</i> , destination operand cannot be an immediate. |
| Examples: | sub cx , word [wVvar] sub rax , 42 sub dword [dVvar] , eax sub qword [qVvar] , 300 |
| dec <operand> | Decrement <operand> by 1. <i>Note</i> , <operand> cannot be an immediate. |
| Examples: | dec word [wVvar] dec rax dec dword [dVvar] dec qword [qVvar] |

A more complete list of the instructions is located in Appendix B.

7.5.3 Integer Multiplication

The multiply instruction multiplies two integer operands. Mathematically, there are special rules for handling multiplication of signed values. As such, different instructions are used for unsigned multiplication (**mul**) and signed multiplication (**imul**).

Multiplication typically produces double sized results. That is, multiplying two n -bit values produces a $2n$ -bit result. Multiplying two 8-bit numbers will produce a 16-bit result. Similarly, multiplication of two 16-bit numbers will produce a 32-bit result, multiplication of two 32-bit numbers will produce a 64-bit result, and multiplication of two 64-bit numbers will produce a 128-bit result.

There are many variants for the multiply instruction. For the signed multiply, some forms will truncate the result to the size of the original operands. It is the programmer's responsibility to ensure that the values used will work for the specific instructions selected.

7.5.3.1 Unsigned Multiplication

The general forms of the unsigned multiplication is as follows:

```
mul    <src>
```

Where the source operand must be a register or memory location. An immediate operand is not allowed.

For the single operand multiply instruction, the **A** register (**al/ax/eax/rax**) must be used for one of the operands (**al** for 8-bits, **ax** for 16-bits, **eax** for 32-bits, and **rax** for 64-bit). The other operand can be a memory location or register, but not an immediate. Additionally, the result will be placed in the **A** and possibly **D** registers, based on the sizes being multiplied. The following table shows the various options for the byte, word, double-word, and quadword unsigned multiplications.

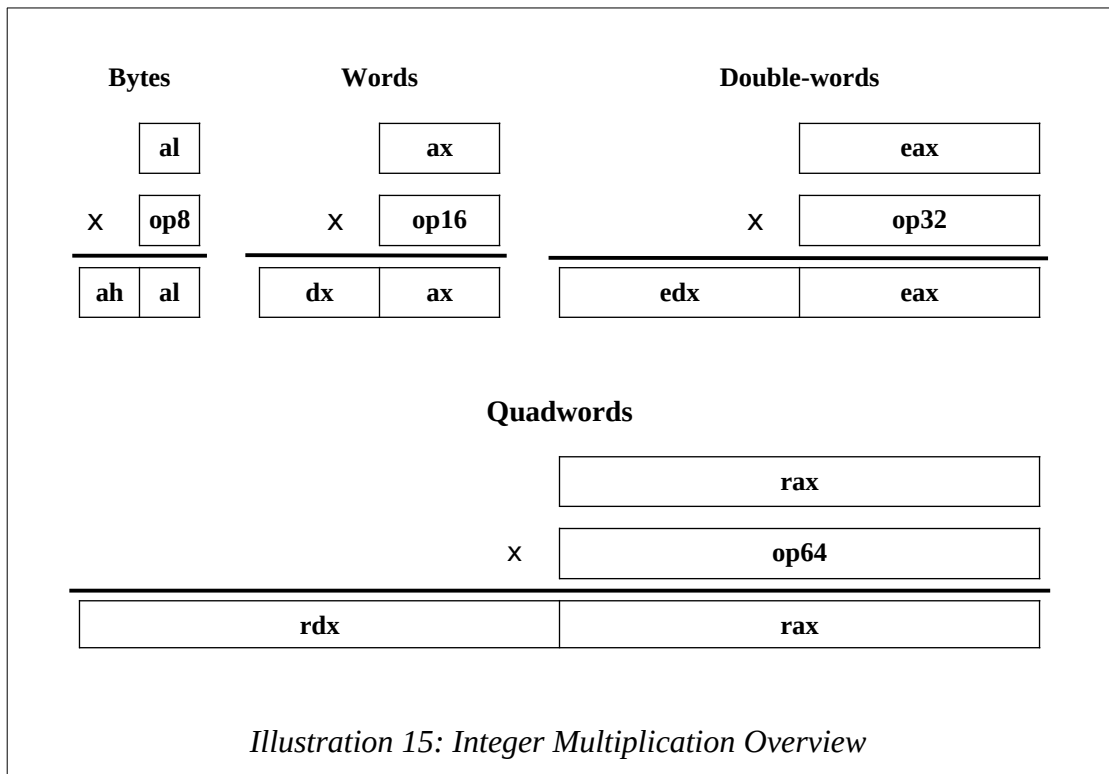

As shown in the chart, for most cases the integer multiply uses a combination of the **A** and **D** registers. This can be very confusing.

For example, when multiplying a **rax** (64-bits) times a quadword operand (64-bits), the multiplication instruction provides a double quadword result (128-bit). This can be useful and important when dealing with very large numbers. Since the 64-bit architecture only has 64-bit registers, the 128-bit result is, and must be, placed in two different quadword (64-bit) registers, **rdx** for the upper order result and **rax** for the lower order result, which is typically written as **rdx:rax** (by convention).

However, this use of two registers is applied to smaller sizes as well. For example, the result of multiplying **ax** (16-bits) times a word operand (also 16-bits) provides a double-word (32-bit) result. However, the result is not placed in **eax** (which might be easier), it is placed in two registers, **dx** for the upper order result (16-bits) and **ax** for the lower order result (16-bits), typically written as **dx:ax** (by convention). Since the double-word (32-bit) result is in two different registers, two moves may be required to save the result.

This pairing of registers, even when not required, is due to legacy support for previous earlier versions of the architecture. While this helps ensure backwards compatibility, it can be quite confusing.

For example, assuming the following data declarations:

| | | |
|---------------|------------|---------------|
| bNumA | db | 42 |
| bNumB | db | 73 |
| wAns | dw | 0 |
| wAns1 | dw | 0 |
| | | |
| wNumA | dw | 4321 |
| wNumB | dw | 1234 |
| dAns2 | dd | 0 |
| | | |
| dNumA | dd | 42000 |
| dNumB | dd | 73000 |
| qAns3 | dq | 0 |
| | | |
| qNumA | dq | 420000 |
| qNumB | dq | 730000 |
| dqAns4 | ddq | 0 |

To perform, the basic operations of:

```

wAns = bNumA^2                ; bNumA squared
bAns1 = bNumA * bNumB
wAns1 = bNumA * bNumB
wAns2 = wNumA * wNumB

```

```
dAns2 = wNumA * wNumB
```

```
dAns3 = dNumA * dNumB
```

```
qAns3 = dNumA * dNumB
```

```
qAns4 = qNumA * qNumB
```

```
dqAns4 = qNumA * qNumB
```

The following instructions could be used:

```
; wAns = bNumA^2 or bNumA squared
mov    al, byte [bNumA]
mul    al                                ; result in ax
mov    word [wAns], ax

; wAns1 = bNumA * bNumB
mov    al, byte [bNumA]
mul    byte [bNumB]                      ; result in ax
mov    word [wAns1], ax

; dAns2 = wNumA * wNumB
mov    ax, word [wNumA]
mul    word [wNumB]                       ; result in dx:ax
mov    word [dAns2], ax
mov    word [dAns2+2], dx

; qAns3 = dNumA * dNumB
mov    eax, dword [dNumA]
mul    dword [dNumB]                      ; result in edx:eax
mov    dword [qAns3], eax
mov    dword [qAns3+4], edx

; dqAns4 = qNumA * qNumB
mov    rax, qword [qNumA]
mul    qword [qNumB]                      ; result in rdx:rax
mov    qword [dqAns4], rax
mov    qword [dqAns4+8], rdx
```

For some instructions, including those above, the explicit type specification (e.g., *byte*, *word*, *dword*, *qword*) is required to clearly define the size.

The integer unsigned multiplication instruction is summarized as follows:

| Instruction | Explanation |
|---|---|
| mul <src> mul <op8> mul <op16> mul <op32> mul <op64> | Multiply A register (al , ax , eax , or rax) times the <src> operand. Byte: ax = al * <src> Word: dx:ax = ax * <src> Double: edx:eax = eax * <src> Quad: rdx:rax = rax * <src> <i>Note, <src> operand cannot be an immediate.</i> |
| Examples: | mul word [wVvar] mul al mul dword [dVvar] mul qword [qVvar] |

A more complete list of the instructions is located in Appendix B.

7.5.3.2 Signed Multiplication

The signed multiplication allows a wider range of operands and operand sizes. The general forms of the signed multiplication are as follows:

```

imul <source>
imul <dest>, <src/imm>
imul <dest>, <src>, <imm>

```

In all cases, the destination operand must be a register. For the multiple operand multiply instruction, byte operands are not supported.

When using a **single** operand multiply instruction, the **imul** is the same layout as the **mul** (as previously presented). However, the operands are interpreted only as signed.

When two operands are used, the destination operand and the source operand are multiplied and the result placed in the destination operand (over-writing the previous value).

Specifically, the action performed is:

$$\langle \text{dest} \rangle = \langle \text{dest} \rangle * \langle \text{src/imm} \rangle$$

For two operands, the **<src/imm>** operand may be a register, memory location, or

immediate value. The size of the immediate value is limited to the size of the source operand, up to a double-word size (32-bit), even for quadword (64-bit) multiplications. The final result is truncated to the size of the destination operand. A byte sized destination operand is not supported.

When three operands are used, two operands are multiplied and the result placed in the destination operand. Specifically, the action performed is:

$$\langle \text{dest} \rangle = \langle \text{src} \rangle * \langle \text{imm} \rangle$$

For three operands, the `<src>` operand must be a register or memory location, but not an immediate. The `<imm>` operand must be an immediate value. The size of the immediate value is limited to the size of the source operand, up to a double-word size (32-bit), even for quadword multiplications. The final result is truncated to the size of the destination operand. A byte sized destination operand is not supported.

It should be noted that when the multiply instruction provides a larger type, the original type may be used. For this to work, the values multiplied must fit into the smaller size which limits the range of the data. For example, when two double-words are multiplied and a quadword result is provided, the least significant double-word (of the quadword) will contain the answer if the values are sufficiently small which is often the case. This is typically done in high-level languages when an `int` (32-bit integer) variable is multiplied by another `int` variable and assigned to an `int` variable.

For example, assuming the following data declarations:

| | | |
|--------------------|-----------------|----------------------|
| <code>wNumA</code> | <code>dw</code> | <code>1200</code> |
| <code>wNumB</code> | <code>dw</code> | <code>-2000</code> |
| <code>wAns1</code> | <code>dw</code> | <code>0</code> |
| <code>wAns2</code> | <code>dw</code> | <code>0</code> |
| | | |
| <code>dNumA</code> | <code>dd</code> | <code>42000</code> |
| <code>dNumB</code> | <code>dd</code> | <code>-13000</code> |
| <code>dAns1</code> | <code>dd</code> | <code>0</code> |
| <code>dAns2</code> | <code>dd</code> | <code>0</code> |
| | | |
| <code>qNumA</code> | <code>dq</code> | <code>120000</code> |
| <code>qNumB</code> | <code>dq</code> | <code>-230000</code> |
| <code>qAns1</code> | <code>dq</code> | <code>0</code> |
| <code>qAns2</code> | <code>dq</code> | <code>0</code> |

To perform, the basic operations of:

```
wAns1 = wNumA * -13
wAns2 = wNumA * wNumB

dAns1 = dNumA * 113
dAns2 = dNumA * dNumB

qAns1 = qNumA * 7096
qAns2 = qNumA * qNumB
```

The following instructions could be used:

```
; wAns1 = wNumA * -13
mov    ax, word [wNumA]
imul   ax, -13                ; result in ax
mov    word [wAns1], ax

; wAns2 = wNumA * wNumB
mov    ax, word [wNumA]
imul   ax, word [wNumB]      ; result in ax
mov    word [wAns2], ax

; dAns1 = dNumA * 113
mov    eax, dword [dNumA]
imul   eax, 113              ; result in eax
mov    dword [dAns1], eax

; dAns2 = dNumA * dNumB
mov    eax, dword [dNumA]
imul   eax, dword [dNumB]    ; result in eax
mov    dword [dAns2], eax

; qAns1 = qNumA * 7096
mov    rax, qword [qNumA]
imul   rax, 7096             ; result in rax
mov    qword [qAns1], rax

; qAns2 = qNumA * qNumB
mov    rax, qword [qNumA]
imul   rax, qword [qNumB]    ; result in rax
mov    qword [qAns2], rax
```

Another way to perform the multiplication of

```
qAns1 = qNumA * 7096
```

Would be as follows:

```
; qAns1 = qNumA * 7096  
mov    rcx, qword [qNumA]  
imul  rbx, rcx, 7096           ; result in rbx  
mov    qword [qAns1], rbx
```

This example shows the three-operand multiply instruction using different registers.

In these examples, the multiplication result is truncated to the size of the destination operand. For a full-sized result, the single operand instruction should be used (as fully described in the section regarding unsigned multiplication).

For some instructions, including those above, the explicit type specification (e.g., *byte*, *word*, *dword*, *qword*) may not be required to clearly define the size.

The integer signed multiplication instruction is summarized as follows:

| Instruction | Explanation |
|---|---|
| <pre>imul <src> imul <dest>, <src/imm32> imul <dest>, <src>, <imm32> imul <op8> imul <op16> imul <op32> imul <op64> imul <reg16>, <op16/imm> imul <reg32>, <op32/imm> imul <reg64>, <op64/imm> imul <reg16>, <op16>, <imm> imul <reg32>, <op32>, <imm> imul <reg64>, <op64>, <imm></pre> | <p>Signed multiply instruction.</p> <p>For single operand: Byte: ax = al * <src> Word: dx:ax = ax * <src> Double: edx:eax = eax * <src> Quad: rdx:rax = rax * <src></p> <p>Note, <src> operand cannot be an immediate.</p> <p>For two operands: <reg16> = <reg16> * <op16/imm> <reg32> = <reg32> * <op32/imm> <reg64> = <reg64> * <op64/imm></p> <p>For three operands: <reg16> = <op16> * <imm> <reg32> = <op32> * <imm> <reg64> = <op64> * <imm></p> |
| <p>Examples:</p> | <pre>imul ax, 17 imul al imul ebx, dword [dVar] imul rbx, dword [dVar], 791 imul rcx, qword [qVar] imul qword [qVar]</pre> |

A more complete list of the instructions is located in Appendix B.

7.5.4 Integer Division

The division instruction divides two integer operands. Mathematically, there are special rules for handling division of signed values. As such, different instructions are used for unsigned division (**div**) and signed division (**idiv**).

Recall that $\frac{\textit{dividend}}{\textit{divisor}} = \textit{quotient}$

Division requires that the dividend must be a larger size than the divisor. In order to divide by an 8-bit divisor, the dividend must be 16-bits (i.e., the larger size). Similarly, a 16-bit divisor requires a 32-bit dividend. And, a 32-bit divisor requires a 64-bit dividend.

Like the multiplication, for most cases the integer division uses a combination of the **A** and **D** registers. This pairing of registers is due to legacy support for previous earlier versions of the architecture. While this helps ensure backwards compatibility, it can be quite confusing.

Further, the **A**, and possibly the **D** register, must be used in combination for the dividend.

- Byte Divide: **ax** for 16-bits
- Word Divide: **dx:ax** for 32-bits
- Double-word divide: **edx:eax** for 64-bits
- Quadword Divide: **rdx:rax** for 128-bits

Setting the dividend (top operand) correctly is a key source of problems. For the word, double-word, and quadword division operations, the dividend requires both the **D** register (for the upper order portion) and **A** (for the lower order portion).

Setting these correctly depends on the data type. If a previous multiplication was performed, the **D** and **A** registers may already be set correctly. Otherwise, a data item may need to be converted from its current size to a larger size with the upper order portion being placed in the **D** register. For unsigned data, the upper portion will always be zero. For signed data, the existing data must be sign extended as noted in a previous section, *Signed Conversions*.

The divisor can be a memory location or register, but not an immediate. Additionally, the result will be placed in the **A** register (**al/ax/eax/rax**) and the remainder in either the **ah**, **dx**, **edx**, or **rdx** register. Refer to the *Integer Division Overview* table to see the layout more clearly.

The use of a larger size operand for the dividend matches the single operand multiplication. For simple divisions, an appropriate conversion may be required in order to ensure the dividend is set correctly. For unsigned divisions, the upper-order part of the dividend can set to zero. For signed divisions, the upper-order part of the dividend can be set with an applicable conversion instruction.

As always, division by zero will crash the program and damage the space-time continuum. So, try not to divide by zero.

The following tables provide an overview of the divide instruction for bytes, words, double-words, and quadwords.

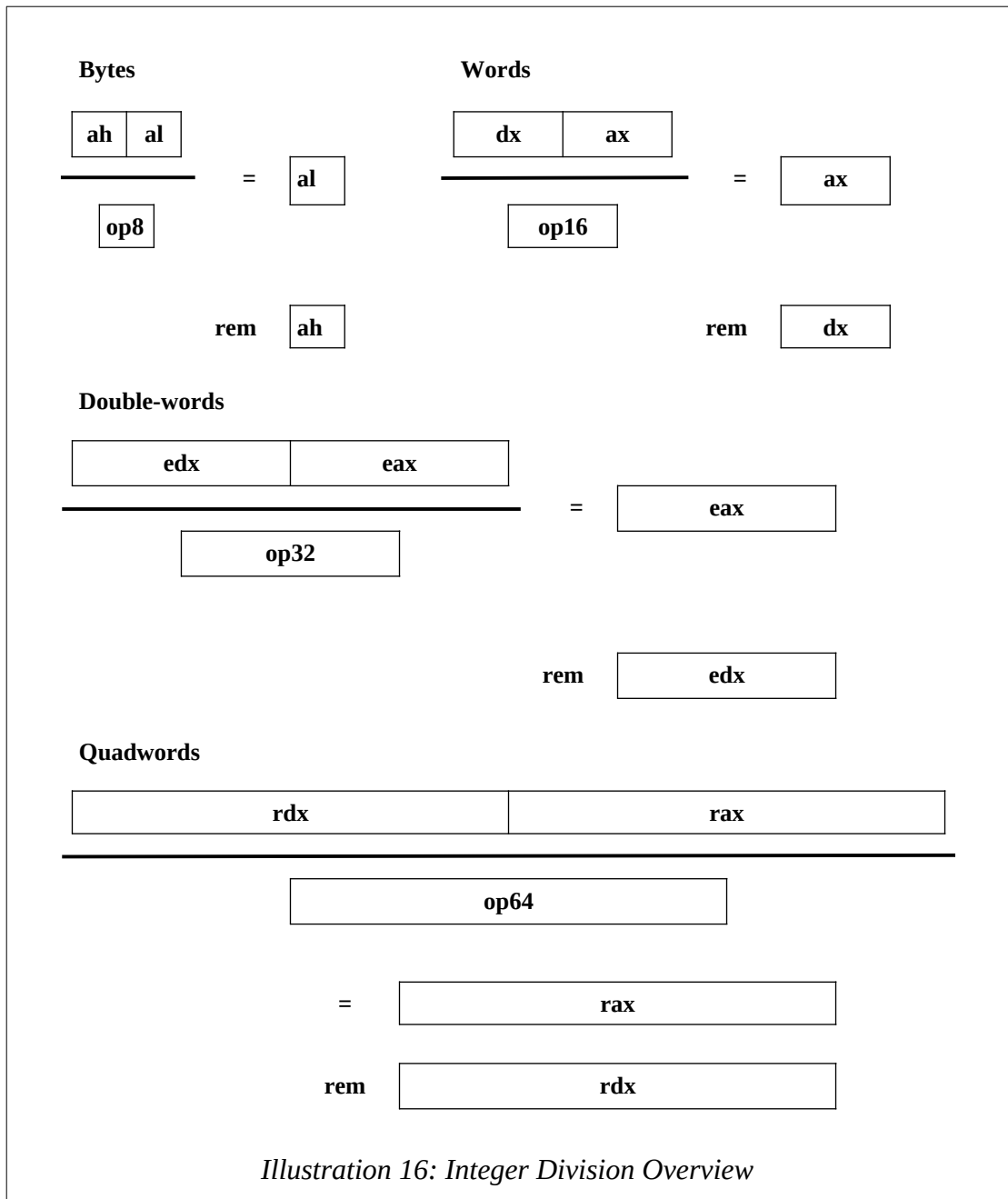

The signed and unsigned division instructions operate in the same manner. However, the range values that can be divided is different. The programmer is responsible for ensuring that the values being divided are appropriate for the operand sizes being used.

The general forms of the unsigned and signed division are as follows:

```
div    <src>                ; unsigned division
idiv   <src>                ; signed division
```

The source operand and destination operands (A and D registers) are described in the preceding table.

For example, assuming the following data declarations:

```
bNumA    db    63
bNumB    db    17
bNumC    db    5
bAns1    db    0
bAns2    db    0
bRem2    db    0
bAns3    db    0

wNumA    dw    4321
wNumB    dw    1234
wNumC    dw    167
wAns1    dw    0
wAns2    dw    0
wRem2    dw    0
wAns3    dw    0

dNumA    dd    42000
dNumB    dd    -3157
dNumC    dd    -293
dAns1    dd    0
dAns2    dd    0
dRem2    dd    0
dAns3    dd    0

qNumA    dq    730000
qNumB    dq    -13456
qNumC    dq    -1279
qAns1    dq    0
qAns2    dq    0
```

```

qRem2      dq      0
qAns3      dq      0

```

To perform, the basic operations of:

```

bAns1 = bNumA / 3           ; unsigned
bAns2 = bNumA / bNumB      ; unsigned
bRem2 = bNumA % bNumB     ; % is modulus
bAns3 = (bNumA * bNumC) / bNumB ; unsigned

wAns1 = wNumA / 5         ; unsigned
wAns2 = wNumA / wNumB    ; unsigned
wRem2 = wNumA % wNumB    ; % is modulus
wAns3 = (wNumA * wNumC) / wNumB ; unsigned

dAns = dNumA / 7         ; signed
dAns3 = dNumA * dNumB    ; signed
dRem1 = dNumA % dNumB    ; % is modulus
dAns3 = (dNumA * dNumC) / dNumB ; signed

qAns = qNumA / 9         ; signed
qAns4 = qNumA * qNumB    ; signed
qRem1 = qNumA % qNumB    ; % is modulus
qAns3 = (qNumA * qNumC) / qNumB ; signed

```

The following instructions could be used:

```

; -----
; example byte operations, unsigned

; bAns1 = bNumA / 3 (unsigned)
mov     al, byte [bNumA]
mov     ah, 0
mov     bl, 3
div     bl           ; al = ax / 3
mov     byte [bAns1], al

; bAns2 = bNumA / bNumB (unsigned)
mov     ax, 0
mov     al, byte [bNumA]
div     byte [bNumB] ; al = ax / bNumB
mov     byte [bAns2], al
mov     byte [bRem2], ah ; ah = ax % bNumB

```

```

; bAns3 = (bNumA * bNumC) / bNumB (unsigned)
mov     al, byte [bNumA]
mul     byte [bNumC]           ; result in ax
div     byte [bNumB]           ; al = ax / bNumB
mov     byte [bAns3], al

; -----
; example word operations, unsigned

; wAns1 = wNumA / 5 (unsigned)
mov     ax, word [wNumA]
mov     dx, 0
mov     bx, 5
div     bx                       ; ax = dx:ax / 5
mov     word [wAns1], ax

; wAns2 = wNumA / wNumB (unsigned)
mov     dx, 0
mov     ax, word [wNumA]
div     word [wNumB]           ; ax = dx:ax / wNumB
mov     word [wAns2], ax
mov     word [wRem2], dx

; wAns3 = (wNumA * wNumC) / wNumB (unsigned)
mov     ax, word [wNumA]
mul     word [wNumC]           ; result in dx:ax
div     word [wNumB]           ; ax = dx:ax / wNumB
mov     word [wAns3], ax

; -----
; example double-word operations, signed

; dAns1 = dNumA / 7 (signed)
mov     eax, dword [dNumA]
cdq                               ; eax → edx:eax
mov     ebx, 7
idiv    ebx                       ; eax = edx:eax / 7
mov     dword [dAns1], eax

```

```

; dAns2 = dNumA / dNumB (signed)
mov    eax, dword [dNumA]
cdq                                ; eax → edx:eax
idiv   dword [dNumB]              ; eax = edx:eax/dNumB
mov    dword [dAns2], eax
mov    dword [dRem2], edx         ; edx = edx:eax%dNumB

; dAns3 = (dNumA * dNumC) / dNumB (signed)
mov    eax, dword [dNumA]
imul   dword [dNumC]             ; result in edx:eax
idiv   dword [dNumB]            ; eax = edx:eax/dNumB
mov    dword [dAns3], eax

; -----
; example quadword operations, signed

; qAns1 = qNumA / 9 (signed)
mov    rax, qword [qNumA]
cqo                                ; rax → rdx:rax
mov    rbx, 9
idiv   rbx                       ; eax = edx:eax / 9
mov    qword [qAns1], rax

; qAns2 = qNumA / qNumB (signed)
mov    rax, qword [qNumA]
cqo                                ; rax → rdx:rax
idiv   qword [qNumB]            ; rax = rdx:rax/qNumB
mov    qword [qAns2], rax
mov    qword [qRem2], rdx        ; rdx = rdx:rax%qNumB

; qAns3 = (qNumA * qNumC) / qNumB (signed)
mov    rax, qword [qNumA]
imul   qword [qNumC]           ; result in rdx:rax
idiv   qword [qNumB]          ; rax = rdx:rax/qNumB
mov    qword [qAns3], rax

```

For some instructions, including those above, the explicit type specification (e.g., *byte*, *word*, *dword*, *qword*) is required to clearly define the size.

The integer division instructions are summarized as follows:

| Instruction | Explanation |
|--|---|
| div <src> div <op8> div <op16> div <op32> div <op64> | Unsigned divide A/D register (ax , dx:ax , edx:eax , or rdx:rax) by the <src> operand. Byte: al = ax / <src> , rem in ah Word: ax = dx:ax / <src> , rem in dx Double: eax = eax / <src> , rem in edx Quad: rax = rax / <src> , rem in rdx <i>Note, <src> operand cannot be an immediate.</i> |
| Examples: | div word [wVvar] div bl div dword [dVar] div qword [qVar] |
| idiv <src> idiv <op8> idiv <op16> idiv <op32> idiv <op64> | Signed divide A/D register (ax , dx:ax , edx:eax , or rdx:rax) by the <src> operand. Byte: al = ax / <src> , rem in ah Word: ax = dx:ax / <src> , rem in dx Double: eax = eax / <src> , rem in edx Quad: rax = rax / <src> , rem in rdx <i>Note, <src> operand cannot be an immediate.</i> |
| Examples: | idiv word [wVvar] idiv bl idiv dword [dVar] idiv qword [qVar] |

A more complete list of the instructions is located in Appendix B.

7.6 Logical Instructions

This section summarizes some of the more common logical instructions that may be useful when programming.

7.6.1 Logical Operations

As you should recall, the below are the truth tables for the basic logical operations;

| | | | | | | | | | | | | | | | | | | | | | | | | | | | | | | | | | | | | | | | | | | | | | | | |
|--|---|---|---|---|---|------------|---|---|---|---|--|---|---|---|---|---|--|---|---|---|---|-----------|---|---|---|---|--|---|---|---|---|--|--|---|---|---|---|------------|---|---|---|---|--|---|---|---|---|
| <table style="border-collapse: collapse; margin: auto;"> <tr> <td style="padding: 5px;"></td> <td style="border: 1px solid black; padding: 5px;">0</td> <td style="border: 1px solid black; padding: 5px;">1</td> <td style="border: 1px solid black; padding: 5px;">0</td> <td style="border: 1px solid black; padding: 5px;">1</td> </tr> <tr> <td style="padding: 5px;">and</td> <td style="border: 1px solid black; padding: 5px;">0</td> <td style="border: 1px solid black; padding: 5px;">0</td> <td style="border: 1px solid black; padding: 5px;">1</td> <td style="border: 1px solid black; padding: 5px;">1</td> </tr> <tr> <td style="padding: 5px;"></td> <td style="border: 1px solid black; padding: 5px;">0</td> <td style="border: 1px solid black; padding: 5px;">0</td> <td style="border: 1px solid black; padding: 5px;">0</td> <td style="border: 1px solid black; padding: 5px;">1</td> </tr> </table> | | 0 | 1 | 0 | 1 | and | 0 | 0 | 1 | 1 | | 0 | 0 | 0 | 1 | <table style="border-collapse: collapse; margin: auto;"> <tr> <td style="padding: 5px;"></td> <td style="border: 1px solid black; padding: 5px;">0</td> <td style="border: 1px solid black; padding: 5px;">1</td> <td style="border: 1px solid black; padding: 5px;">0</td> <td style="border: 1px solid black; padding: 5px;">1</td> </tr> <tr> <td style="padding: 5px;">or</td> <td style="border: 1px solid black; padding: 5px;">0</td> <td style="border: 1px solid black; padding: 5px;">0</td> <td style="border: 1px solid black; padding: 5px;">1</td> <td style="border: 1px solid black; padding: 5px;">1</td> </tr> <tr> <td style="padding: 5px;"></td> <td style="border: 1px solid black; padding: 5px;">0</td> <td style="border: 1px solid black; padding: 5px;">1</td> <td style="border: 1px solid black; padding: 5px;">1</td> <td style="border: 1px solid black; padding: 5px;">1</td> </tr> </table> | | 0 | 1 | 0 | 1 | or | 0 | 0 | 1 | 1 | | 0 | 1 | 1 | 1 | <table style="border-collapse: collapse; margin: auto;"> <tr> <td style="padding: 5px;"></td> <td style="border: 1px solid black; padding: 5px;">0</td> <td style="border: 1px solid black; padding: 5px;">1</td> <td style="border: 1px solid black; padding: 5px;">0</td> <td style="border: 1px solid black; padding: 5px;">1</td> </tr> <tr> <td style="padding: 5px;">xor</td> <td style="border: 1px solid black; padding: 5px;">0</td> <td style="border: 1px solid black; padding: 5px;">0</td> <td style="border: 1px solid black; padding: 5px;">1</td> <td style="border: 1px solid black; padding: 5px;">1</td> </tr> <tr> <td style="padding: 5px;"></td> <td style="border: 1px solid black; padding: 5px;">0</td> <td style="border: 1px solid black; padding: 5px;">1</td> <td style="border: 1px solid black; padding: 5px;">1</td> <td style="border: 1px solid black; padding: 5px;">0</td> </tr> </table> | | 0 | 1 | 0 | 1 | xor | 0 | 0 | 1 | 1 | | 0 | 1 | 1 | 0 |
| | 0 | 1 | 0 | 1 | | | | | | | | | | | | | | | | | | | | | | | | | | | | | | | | | | | | | | | | | | | |
| and | 0 | 0 | 1 | 1 | | | | | | | | | | | | | | | | | | | | | | | | | | | | | | | | | | | | | | | | | | | |
| | 0 | 0 | 0 | 1 | | | | | | | | | | | | | | | | | | | | | | | | | | | | | | | | | | | | | | | | | | | |
| | 0 | 1 | 0 | 1 | | | | | | | | | | | | | | | | | | | | | | | | | | | | | | | | | | | | | | | | | | | |
| or | 0 | 0 | 1 | 1 | | | | | | | | | | | | | | | | | | | | | | | | | | | | | | | | | | | | | | | | | | | |
| | 0 | 1 | 1 | 1 | | | | | | | | | | | | | | | | | | | | | | | | | | | | | | | | | | | | | | | | | | | |
| | 0 | 1 | 0 | 1 | | | | | | | | | | | | | | | | | | | | | | | | | | | | | | | | | | | | | | | | | | | |
| xor | 0 | 0 | 1 | 1 | | | | | | | | | | | | | | | | | | | | | | | | | | | | | | | | | | | | | | | | | | | |
| | 0 | 1 | 1 | 0 | | | | | | | | | | | | | | | | | | | | | | | | | | | | | | | | | | | | | | | | | | | |
| <i>Illustration 17: Logical Operations</i> | | | | | | | | | | | | | | | | | | | | | | | | | | | | | | | | | | | | | | | | | | | | | | | |

The logical instructions are summarized as follows:

| Instruction | Explanation |
|--------------------------|---|
| and <dest>, <src> | Perform logical AND operation on two operands, (<dest> and <src>) and place the result in <dest> (over-writing previous value). <i>Note 1</i> , both operands cannot be memory. <i>Note 2</i> , destination operand cannot be an immediate. |
| Examples: | and ax, bx and rcx, rdx and eax, dword [dNum] and qword [qNum], rdx |
| or <dest>, <src> | Perform logical OR operation on two operands, (<dest> <src>) and place the result in <dest> (over-writing previous value). <i>Note 1</i> , both operands cannot be memory. <i>Note 2</i> , destination operand cannot be an immediate. |
| Examples: | or ax, bx or rcx, rdx or eax, dword [dNum] or qword [qNum], rdx |

| Instruction | Explanation |
|--------------------------|---|
| xor <dest>, <src> | Perform logical XOR operation on two operands, (<dest> ^ <src>) and place the result in <dest> (over-writing previous value). <i>Note 1</i> , both operands cannot be memory. <i>Note 2</i> , destination operand cannot be an immediate. |
| Examples: | xor ax, bx xor rcx, rdx xor eax, dword [dNum] xor qword [qNum], rdx |
| not <op> | Perform a logical not operation (one's complement on the operand 1's → 0's and 0's → 1's). <i>Note</i> , operand cannot be an immediate. |
| Examples: | not bx not rdx not dword [dNum] not qword [qNum] |

The **&** refers to the logical AND operation, the **||** refers to the logical OR operation, and the **^** refers to the logical XOR operation as per C/C++ conventions. The **~** refers to the logical NOT operation.

A more complete list of the instructions is located in Appendix B.

7.6.2 Shift Operations

The shift operation shifts bits within an operand, either left or right. Two typical reasons for shifting bits include isolating a subset of the bits within an operand for some specific purpose or possibly for performing multiplication or division by powers of two. All bits are shifted one position. The bit that is shifted outside the operand is lost and a 0-bit added at the other side.

7.6.2.1 Logical Shift

The logical shift is a bitwise operation that shifts all the bits of its source register by the specified number of bits places the result into the destination register. The bits can be

shifted left or right as needed. Every bit in the source operand is moved the specified number of bit positions and the newly vacant bit-positions are filled in with zeros.

The following diagram shows how the right and left shift operations work for byte sized operands.

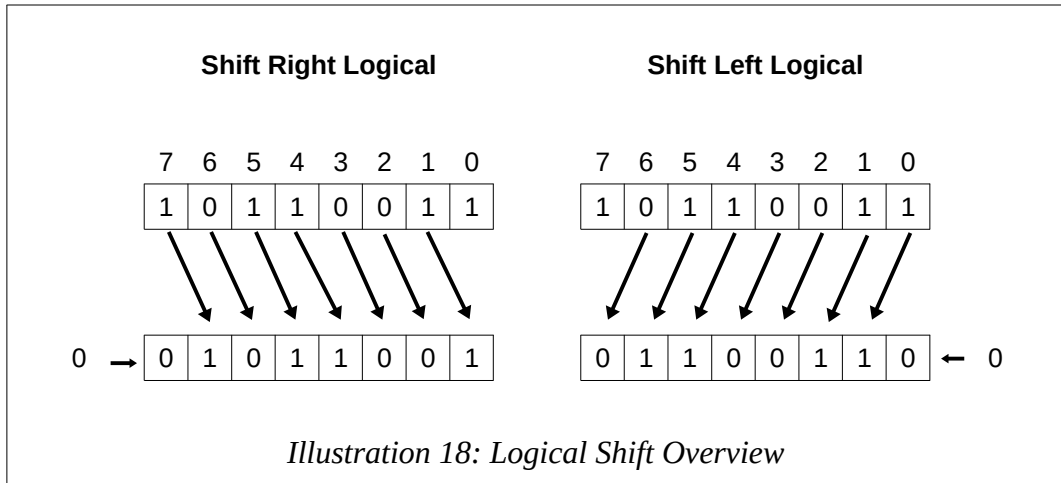

The logical shift treats the operand as a sequence of bits rather than as a number.

The shift instructions may be used to perform unsigned integer multiplication and division operations for powers of 2. Powers of two would be 2, 4, 8, etc. up to the limit of the operand size (32-bits for register operands).

In the examples below, 23 is divided by 2 by performing a shift right logical one bit. The resulting 11 is shown in binary. Next, 13 is multiplied by 4 by performing a shift left logical two bits. The resulting 52 is shown in binary.

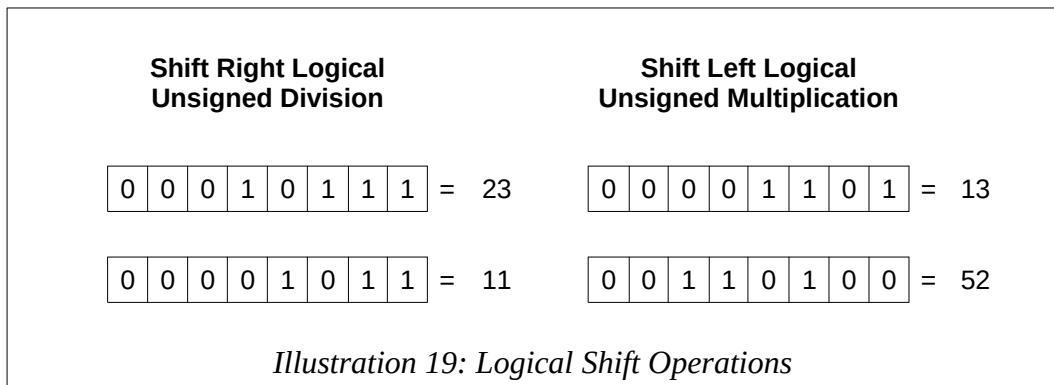

As can be seen in the examples, a 0 was entered in the newly vacated bit locations on either the right or left (depending on the operation).

The logical shift instructions are summarized as follows:

| Instruction | Explanation |
|---|--|
| <pre>shl <dest>, <imm> shl <dest>, cl</pre> | Perform logical shift left operation on destination operand. Zero fills from left (as needed). The <imm> or the value in cl register must be between 1 and 64. <i>Note</i> , destination operand cannot be an immediate. |
| Examples: | <pre>shl ax, 8 shl rcx, 32 shl eax, cl shl qword [qNum], cl</pre> |
| <pre>shr <dest>, <imm> shr <dest>, cl</pre> | Perform logical shift right operation on destination operand. Zero fills from right (as needed). The <imm> or the value in cl register must be between 1 and 64. <i>Note</i> , destination operand cannot be an immediate. |
| Examples: | <pre>shr ax, 8 shr rcx, 32 shr eax, cl shr qword [qNum], cl</pre> |

A more complete list of the instructions is located in Appendix B.

7.6.2.2 Arithmetic Shift

The arithmetic shift right is also a bitwise operation that shifts all the bits of its source register by the specified number of bits places the result into the destination register. Every bit in the source operand is moved the specified number of bit positions, and the newly vacant bit-positions are filled in. For an arithmetic left shift, the

The original leftmost bit (the sign bit) is replicated to fill in all the vacant positions.

This is referred to as sign extension.

The following diagrams show how the shift left and shift right arithmetic operations works for a byte sized operand.

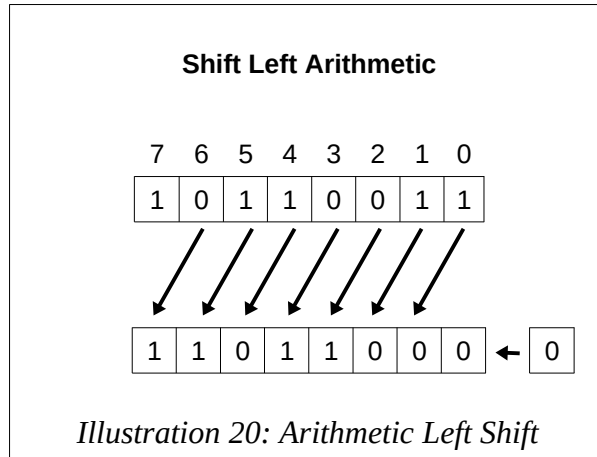

The arithmetic left shift moves bits the number of specified places to the left and zero fills the from the least significant bit position (left). The leading sign bit is not preserved. The arithmetic left shift can be useful to perform an efficient multiplication by a power of two. If the resulting value does not fit an overflow is generated.

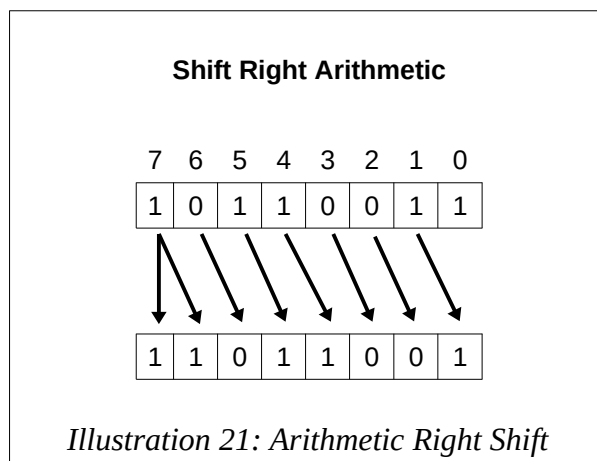

The arithmetic right shift moves bits the number of specified places to the right and treats the operand as a signed number which extends the sign (negative in this example).

The arithmetic shift rounds always rounds down (towards negative infinity) and the standard divide instruction truncates (rounds toward 0). As such, the arithmetic shift is not typically used to replace the signed divide instruction.

The arithmetic shift instructions are summarized as follows:

| Instruction | Explanation |
|---|--|
| <pre>sal <dest>, <imm> sal <dest>, cl</pre> | <p>Perform arithmetic shift left operation on destination operand. Zero fills from right (as needed).</p> <p>The <imm> or the value in cl register must be between 1 and 64.</p> <p><i>Note</i>, destination operand cannot be an immediate.</p> |
| Examples: | <pre>sal ax, 8 sal rcx, 32 sal eax, cl sal qword [qNum], cl</pre> |
| <pre>sar <dest>, <imm> sar <dest>, cl</pre> | <p>Perform arithmetic shift right operation on destination operand. Sign fills from left (as needed).</p> <p>The <imm> or the value in cl register must be between 1 and 64.</p> <p><i>Note</i>, destination operand cannot be an immediate.</p> |
| Examples: | <pre>sar ax, 8 sar rcx, 32 sar eax, cl sar qword [qNum], cl</pre> |

A more complete list of the instructions is located in Appendix B.

7.6.3 Rotate Operations

The rotate operation shifts bits within an operand, either left or right, with the bit that is shifted outside the operand is rotated around and placed at the other end.

For example, if a byte operand, 10010110_2 , is rotated to the right 1 place, the result would be 01001011_2 . If a byte operand, 10010110_2 , is rotated to the left 1 place, the

result would be 00101101₂.

The logical shift instructions are summarized as follows:

| Instruction | Explanation |
|---|--|
| <pre>rol <dest>, <imm> rol <dest>, cl</pre> | Perform rotate left operation on destination operand. The <imm> or the value in cl register must be between 1 and 64. <i>Note</i> , destination operand cannot be an immediate. |
| Examples: | <pre>rol ax, 8 rol rcx, 32 rol eax, cl rol qword [qNum], cl</pre> |
| <pre>ror <dest>, <imm> ror <dest>, cl</pre> | Perform rotate right operation on destination operand. The <imm> or the value in cl register must be between 1 and 64. <i>Note</i> , destination operand cannot be an immediate. |
| Examples: | <pre>ror ax, 8 ror rcx, 32 ror eax, cl ror qword [qNum], cl</pre> |

A more complete list of the instructions is located in Appendix B.

7.7 Control Instructions

Program control refers to basic programming structures such as IF statements and looping.

All of the high-level language control structures must be performed with the limited assembly-language control structures. For example, an IF-THEN-ELSE statement does not exist as the assembly-language level. Assembly-language provided an unconditional branch (or jump) and a conditional branch or an IF statement that will jump to a target label or not jump.

The control instructions refer to unconditional and conditional jumping. Jumping is required for basic conditional statements (i.e., IF statements) and looping.

7.7.1 Labels

A program label is the target, or a location to jump to, for control statements. For example, the start of a loop might be marked with a label such as “loopStart”. The code may be re-executed by jumping to the label.

A label must start with a letter, following by letters, numbers, or symbols (limited to “_”), terminated with a colon (“:”). Labels in **yasm** are case sensitive.

For example,

```
loopStart:
last:
```

are valid labels. Program labels may be defined only once.

The following sections describe how labels are used.

7.7.2 Unconditional Control Instructions

The unconditional instruction provides an unconditional jump to a specific location in the program denoted with a program label. The target label must be defined exactly once and accessible and within scope from the originating jump instruction.

The unconditional jump instruction is summarized as follows:

| Instruction | Explanation |
|--------------------|--|
| jmp <label> | Jump to specified label. <i>Note</i> , label must be defined exactly once. |
| Examples: | <pre>jmp startLoop jmp ifDone jmp last</pre> |

A more complete list of the instructions is located in Appendix B.

7.7.3 Conditional Control Instructions

The conditional control instructions provide a conditional jump based on a comparison. This provides the functionality of a basic IF statement.

Two steps are required for a comparison; the compare instruction and the conditional jump instruction. The conditional jump instruction will jump or not jump to the provided label based on the result of the previous comparison operation. The compare instruction will compare two operands and store the results of the comparison in the **rFlag** registers. The conditional jump instruction will act (jump or not jump) based on the contents of the **rFlag** register. This requires that the compare instruction is immediately followed by the conditional jump instruction. If other instructions are placed between the compare and conditional jump, the **rFlag** register will be altered and the conditional jump may not reflect the correct condition.

The general form of the compare instruction is:

```
cmp    <op1>, <op2>
```

Where <op1> and <op2> are not changed and must be of the same size. Either, but not both, may be a memory operand. The <op1> operand cannot be an immediate, but the <op2> operand may be an immediate value.

The conditional control instructions include the jump equal (**je**) and jump not equal (**jne**) which work the same for both signed and unsigned data.

The signed conditional control instructions include the basic set of comparison operations; jump less than (**j1**), jump less than or equal (**jle**), jump greater than (**jg**), and jump greater than or equal (**jge**).

The unsigned conditional control instructions include the basic set of comparison operations; jump below than (**jb**), jump below or equal (**jbe**), jump above than (**ja**), and jump above or equal (**jae**).

The general form of the signed conditional instructions along with an explanatory comment are as follows:

```
je    <label>          ; if <op1> == <op2>
jne  <label>          ; if <op1> != <op2>

j1    <label>          ; signed, if <op1> < <op2>
jle  <label>          ; signed, if <op1> <= <op2>
jg    <label>          ; signed, if <op1> > <op2>
jge  <label>          ; signed; if <op1> >= <op2>

jb    <label>          ; unsigned, if <op1> < <op2>
jbe  <label>          ; unsigned, if <op1> <= <op2>
ja    <label>          ; unsigned, if <op1> > <op2>
jae  <label>          ; unsigned, if <op1> >= <op2>
```

For example, given the following pseudo-code for signed data:

```
if (currNum > myMax)
    myMax = currNum;
```

And, assuming the following data declarations:

```
currNum    dq    0
myMax      dq    0
```

Assuming that the values are updating appropriately within the program (not shown), the following instructions could be used:

```
mov    rax, qword [currNum]
cmp    rax, qword [myMax]           ; if currNum <= myMax
jle    notNewMax                    ; skip set new max
mov    qword [myMax], rax
notNewMax:
```

Note that the logic for the IF statement has been reversed. The compare and conditional jump provide functionality for jump or not jump. As such, if the condition from the original IF statement is false, the code must not be executed. Thus, when false, in order to skip the execution, the conditional jump will jump to the target label immediately following the code to be skipped (not executed). While there is only one line in this example, there can be many lines of code.

A more complex example might be as follows:

```
if (x != 0) {
    ans = x / y;
    errFlg = FALSE;
} else {
    ans = 0;
    errFlg = TRUE;
}
```

This basic compare and conditional jump do not provide a typical IF-ELSE structure. It must be created. Assuming the *x* and *y* variables are signed double-words that will be set during the program execution, and the following declarations:

```
TRUE      equ    1
FALSE     equ    0
x         dd     0
y         dd     0
```



```

ans          dd      0
errFlg       db      FALSE

```

The following code could be used to implement the above IF-ELSE statement.

```

cmp          dword [x], 0                ; if statement
je           doElse
mov          eax, dword [x]
cdq
idiv         dword [y]
mov          dword [ans], eax
mov          byte [errFlg], FALSE
jmp          skipElse
doElse:
mov          dword [ans], 0
mov          byte [errFlg], TRUE
skipElse:

```

In this example, since the data was signed, a signed division (**idiv**) and the appropriate conversion (**cdq** in this case) were required. It should also be noted that the **edx** register was over-written even though it did not appear explicitly. If a value was previously placed in **edx** (or **rdx**), it has been altered.

7.7.3.1 Jump Out Of Range

The target label is referred to as a short-jump. Specifically, that means the target label must be within ± 128 bytes from the conditional jump instruction. While this limit is not typically a problem, for very large loops, the assembler may generate an error referring to “jump out-of-range”. The unconditional jump (**jmp**) is not limited in range. If a “jump out-of-range” is generated, it can be eliminated by reversing the logic and using an unconditional jump for the long jump. For example, the following code:

```

cmp          rcx, 0
jne          startOfLoop

```

might generate a “jump out-of-range” assembler error if the label, **startOfLoop**, is a long distance away. The error can be eliminated with the following code:

```

cmp          rcx, 0
je          endOfLoop
jmp          startOfLoop
endOfLoop:

```

Which accomplishes the same thing using an unconditional jump for the long jump and adding a conditional jump to a very close label.

The conditional jump instructions are summarized as follows:

| Instruction | Explanation |
|-------------------------|---|
| cmp <op1>, <op2> | Compare <op1> with <op2>. Results are stored in the rFlag register. <i>Note 1</i> , operands are not changed. <i>Note 2</i> , both operands cannot be memory. <i>Note 3</i> , <op1> operand cannot be an immediate. |
| Examples: | cmp rax, 5 cmp ecx, edx cmp ax, word [wNum] |
| je <label> | Based on preceding comparison instruction, jump to <label> if <op1> == <op2>. Label must be defined exactly once. |
| Examples: | cmp rax, 5 je wasEqual |
| jne <label> | Based on preceding comparison instruction, jump to <label> if <op1> != <op2>. Label must be defined exactly once. |
| Examples: | cmp rax, 5 jne wasNotEqual |
| j1 <label> | For signed data, based on preceding comparison instruction, jump to <label> if <op1> < <op2>. Label must be defined exactly once. |
| Examples: | cmp rax, 5 j1 wasLess |

| Instruction | Explanation |
|--------------------|---|
| jle <label> | For signed data, based on preceding comparison instruction, jump to <label> if <op1> ≤ <op2>. Label must be defined exactly once. |
| Examples: | cmp rax, 5 jle wasLessOrEqual |
| jg <label> | For signed data, based on preceding comparison instruction, jump to <label> if <op1> > <op2>. Label must be defined exactly once. |
| Examples: | cmp rax, 5 jg wasGreater |
| jge <label> | For signed data, based on preceding comparison instruction, jump to <label> if <op1> ≥ <op2>. Label must be defined exactly once. |
| Examples: | cmp rax, 5 jge wasGreaterOrEqual |
| jb <label> | For unsigned data, based on preceding comparison instruction, jump to <label> if <op1> < <op2>. Label must be defined exactly once. |
| Examples: | cmp rax, 5 jb wasLess |
| jbe <label> | For unsigned data, based on preceding comparison instruction, jump to <label> if <op1> ≤ <op2>. Label must be defined exactly once. |
| Examples: | cmp rax, 5 jbe wasLessOrEqual |

| Instruction | Explanation |
|--------------------|---|
| ja <label> | For unsigned data, based on preceding comparison instruction, jump to <label> if <op1> > <op2>. Label must be defined exactly once. |
| Examples: | cmp rax, 5 ja wasGreater |
| jae <label> | For unsigned data, based on preceding comparison instruction, jump to <label> if <op1> ≥ <op2>. Label must be defined exactly once. |
| Examples: | cmp rax, 5 jae wasGreaterOrEqual |

A more complete list of the instructions is located in Appendix B.

7.7.4 Iteration

The basic control instructions outlined provide a means to iterate or loop.

A basic loop can be implemented consisting of a counter which is checked at either the bottom or top of a loop with a compare and conditional jump.

For example, assuming the following declarations:

```
lpCnt    dq    15
sum      dq    0
```

The following code would sum the odd integers from 1 to 30:

```
mov     rcx, qword [lpCnt]    ; loop counter
mov     rax, 1                ; odd integer counter
sumLoop:
add     qword [sum], rax     ; sum current odd integer
add     rax, 2                ; set next odd integer
dec     rcx                   ; decrement loop counter
cmp     rcx, 0
jne     sumLoop
```

This is just one of many different ways to accomplish the odd integer summation task. In this example, **rcx** was used as a loop counter and **rax** was used for the current odd integer (appropriately initialized to 1 and incremented by 2).

The process shown using **rcx** as a counter is useful when looping a predetermined number of times. There is a special instruction, **loop**, provides looping support.

The general format is as follows:

```
loop    <label>
```

Which will perform the decrement of the **rcx** register, comparison to 0, and jump to the specified label if $rcx \neq 0$. The label must be defined exactly once.

As such, the loop instruction provides the same functionality as the three lines of code from the previous example program. The following sets of code are equivalent:

Code Set 1

```
loop    <label>
```

Code Set 2

```
dec    rcx
cmp    rcx, 0
jne    <label>
```

For example, the previous program can be written as follows:

```

mov    rcx, qword [maxN]      ; loop counter
mov    rax, 1                    ; odd integer counter
sumLoop:
add    qword [sum], rax        ; sum current odd integer
add    rax, 2                    ; set next odd integer
loop    sumLoop
```

Both code examples produce the exact same result in the same manner.

Since the **rcx** register is decremented and then checked, forgetting to set the **rcx** register could result in looping an unknown number of times. This is likely to generate an error during the loop execution, which can be very misleading when debugging.

The **loop** instruction can be useful when coding, but it is limited to the **rcx** register and to counting down. If nesting loops are required, the use of a loop instruction for both the inner and outer loop can cause a conflict unless additional actions are taken (i.e., save/restore **rcx** register as required for inner loop).

While some of the programming examples in this text will use the loop instruction, it is not required.

The loop instruction is summarized as follows:

| Instruction | Explanation |
|---------------------------------|---|
| <code>loop <label></code> | Decrement <code>rcx</code> register and jump to <code><label></code> if <code>rcx</code> is $\neq 0$. <i>Note</i> , label must be defined exactly once. |
| Examples: | <pre> loop startLoop loop ifDone loop sumLoop </pre> |

A more complete list of the instructions is located in Appendix B.

7.8 Example Program, Sum of Squares

The following is a complete example program to find the sum of squares from 1 to n . For example, the sum of squares for 10 is as follows:

$$1^2 + 2^2 + \dots + 10^2 = 385$$

This example main initializes the n value to 10 to match the above example.

```

; Simple example program to compute the
; sum of squares from 1 to n.

; *****
; Data declarations

section    .data

; -----
; Define constants

SUCCESS      equ    0           ; Successful operation
SYS_exit     equ    60         ; call code for terminate

; Define Data.

```

```

n            dd      10
sumOfSquares dq      0
; *****

section      .text
global      _start
_start:

; -----
; Compute sum of squares from 1 to n.
; Approach:
;   for (i=1; i<n; i++)
;       sumOfSquares += i^2;

        mov     rbx, 1                ; i
        mov     ecx, dword [n]
sumLoop:
        mov     rax, rbx              ; get i
        mul    rax                    ; i^2
        add    qword [sumOfSquares], rax
        inc    rbx
        loop   sumLoop

; -----
; Done, terminate program.

last:
        mov     rax, SYS_exit         ; call code for exit
        mov     rdi, SUCCESS         ; exit with success
        syscall

```

The debugger can be used to examine the results and verify correct execution of the program.

7.9 Exercises

Below are some quiz questions and suggested projects based on this chapter.

7.9.1 Quiz Questions

Below are some quiz questions based on this chapter.

- 1) Which of the following instructions is legal / illegal? As appropriate, provide an explanation.
 1. `mov rax, 54`
 2. `mov ax, 54`
 3. `mov al, 354`
 4. `mov rax, r11`
 5. `mov rax, r11d`
 6. `mov 54, ecx`
 7. `mov rax, qword [qVar]`
 8. `mov rax, qword [bVar]`
 9. `mov rax, [qVar]`
 10. `mov rax, qVar`
 11. `mov eax, dword [bVar]`
 12. `mov qword [qVar2], qword [qVar1]`
 13. `mov qword [bVar2], qword [qVar1]`
 14. `mov r15, 54`
 15. `mov r16, 54`
 16. `mov r11b, 54`
- 2) Explain what each of the following instructions does.
 1. `movzx rsi, byte [bVar1]`
 2. `movsx rsi, byte [bVar1]`
- 3) What instruction is used to:
 1. convert an *unsigned* byte in **al** into a word in **ax**.
 2. convert a *signed* byte in **al** into a word in **ax**.

- 4) What instruction is used to:
1. convert an *unsigned* word in **ax** into a double-word in **eax**.
 2. convert a *signed* word in **ax** into a double-word in **eax**.
- 5) What instruction is used to:
1. convert an *unsigned* word in **ax** into a double-word in **dx:ax**.
 2. convert a *signed* word in **ax** into a double-word in **dx:ax**.
- 6) Explain the difference between the **cwd** instruction and the **movsx** instructions.
- 7) Explain why the explicit type specification (*dword* in this example) is required on the first instruction and is not required on the second instruction.
1. **add [dVar], eax**
 2. **add dword [dVar], 1**
- 8) Given the following code fragment:

```
mov rax, 9
mov rbx, 2
add rbx, rax
```

What would be in the **rax** and **rbx** registers after execution? Show answer in hex, full register size.

- 9) Given the following code fragment:

```
mov rax, 9
mov rbx, 2
sub rax, rbx
```

What would be in the **rax** and **rbx** registers after execution? Show answer in hex, full register size.

- 10) Given the following code fragment:

```
mov rax, 9
mov rbx, 2
sub rbx, rax
```

What would be in the **rax** and **rbx** registers after execution? Show answer in hex, full register size.

11) Given the following code fragment:

```
mov    rax, 4
mov    rbx, 3
imul  rbx
```

What would be in the **rax** and **rdx** registers after execution? Show answer in hex, full register size.

12) Given the following code fragment:

```
mov    rax, 5
cqo
mov    rbx, 3
idiv  rbx
```

What would be in the **rax** and **rdx** registers after execution? Show answer in hex, full register size.

13) Given the following code fragment:

```
mov    rax, 11
cqo
mov    rbx, 4
idiv  rbx
```

What would be in the **rax** and **rdx** registers after execution? Show answer in hex, full register size.

14) Explain why each of the following statements will not work.

1. `mov 42, eax`
2. `div 3`
3. `mov dword [num1], dword [num1]`
4. `mov dword [ax], 800`

15) Explain why the following code fragment will not work correctly.

```
mov    eax, 500
mov    ebx, 10
idiv  ebx
```

16) Explain why the following code fragment will not work correctly.

```
mov    eax, -500
cdq
mov    ebx, 10
div    ebx
```

17) Explain why the following code fragment will not work correctly.

```
mov    ax, -500
cwd
mov    bx, 10
idiv  bx
mov    dword [ans], eax
```

18) Under what circumstances can the three-operand multiple be used?

7.9.2 Suggested Projects

Below are some suggested projects based on this chapter.

1) Create a program to compute the following expressions using unsigned byte variables and unsigned operations. *Note*, the first letter of the variable name denotes the size (**b** → byte and **w** → word).

1. **bAns1** = **bNum1** + **bNum2**
2. **bAns2** = **bNum1** + **bNum3**
3. **bAns3** = **bNum3** + **bNum4**
4. **bAns6** = **bNum1** – **bNum2**
5. **bAns7** = **bNum1** – **bNum3**
6. **bAns8** = **bNum2** – **bNum4**
7. **wAns11** = **bNum1** * **bNum3**
8. **wAns12** = **bNum2** * **bNum2**
9. **wAns13** = **bNum2** * **bNum4**
10. **bAns16** = **bNum1** / **bNum2**
11. **bAns17** = **bNum3** / **bNum4**

$$12. \text{bAns18} = \text{wNum1} / \text{bNum4}$$

$$13. \text{bRem18} = \text{wNum1} \% \text{bNum4}$$

Use the debugger to execute the program and display the final results. Create a debugger input file to show the results in both decimal and hexadecimal.

- 2) Repeat the previous program using signed values and signed operations. Use the debugger to execute the program and display the final results. Create a debugger input file to show the results in both decimal and hexadecimal.
- 3) Create a program to complete the following expressions using unsigned word sized variables. *Note*, the first letter of the variable name denotes the size (**w** → word and **d** → double-word).

$$1. \text{wAns1} = \text{wNum1} + \text{wNum2}$$

$$2. \text{wAns2} = \text{wNum1} + \text{wNum3}$$

$$3. \text{wAns3} = \text{wNum3} + \text{wNum4}$$

$$4. \text{wAns6} = \text{wNum1} - \text{wNum2}$$

$$5. \text{wAns7} = \text{wNum1} - \text{wNum3}$$

$$6. \text{wAns8} = \text{wNum2} - \text{wNum4}$$

$$7. \text{dAns11} = \text{wNum1} * \text{wNum3}$$

$$8. \text{dAns12} = \text{wNum2} * \text{wNum2}$$

$$9. \text{dAns13} = \text{wNum2} * \text{wNum4}$$

$$10. \text{wAns16} = \text{wNum1} / \text{wNum2}$$

$$11. \text{wAns17} = \text{wNum3} / \text{wNum4}$$

$$12. \text{wAns18} = \text{dNum1} / \text{wNum4}$$

$$13. \text{wRem18} = \text{dNum1} \% \text{wNum4}$$

Use the debugger to execute the program and display the final results. Create a debugger input file to show the results in both decimal and hexadecimal.

- 4) Repeat the previous program using signed values and signed operations. Use the debugger to execute the program and display the final results. Create a debugger input file to show the results in both decimal and hexadecimal.

- 5) Create a program to complete the following expressions using unsigned double-word sized variables. *Note*, the first letter of the variable name denotes the size (**d** → double-word and **q** → quadword).
1. **dAns1 = dNum1 + dNum2**
 2. **dAns2 = dNum1 + dNum3**
 3. **dAns3 = dNum3 + dNum4**
 4. **dAns6 = dNum1 - dNum2**
 5. **dAns7 = dNum1 - dNum3**
 6. **dAns8 = dNum2 - dNum4**
 7. **qAns11 = dNum1 * dNum3**
 8. **qAns12 = dNum2 * dNum2**
 9. **qAns13 = dNum2 * dNum4**
 10. **dAns16 = dNum1 / dNum2**
 11. **dAns17 = dNum3 / dNum4**
 12. **dAns18 = qNum1 / dNum4**
 13. **dRem18 = qNum1 % dNum4**

Use the debugger to execute the program and display the final results. Create a debugger input file to show the results in both decimal and hexadecimal.

- 6) Repeat the previous program using signed values and signed operations. Use the debugger to execute the program and display the final results. Create a debugger input file to show the results in both decimal and hexadecimal.
- 7) Implement the example program to compute the sum of squares from 1 to **n**. Use the debugger to execute the program and display the final results. Create a debugger input file to show the results in both decimal and hexadecimal.
- 8) Create a program to compute the square of the sum from 1 to **n**. Specifically, compute the sum of integers from 1 to **n** and then square the value. Use the debugger to execute the program and display the final results. Create a debugger input file to show the results in both decimal and hexadecimal.

- 9) Create a program to iteratively find the *n*th Fibonacci number³⁷. The value for *n* should be set as a parameter (e.g., a programmer defined constant). The formula for computing Fibonacci is as follows:

$$fibonacci(n) = \begin{cases} n & \text{if } n=0 \text{ or } n=1 \\ fibonacci(n-2) + \\ \quad fibonacci(n-1) & \text{if } n \geq 2 \end{cases}$$

Use the debugger to execute the program and display the final results. Test the program for various values of *n*. Create a debugger input file to show the results in both decimal and hexadecimal.

³⁷ For more information, refer to: http://en.wikipedia.org/wiki/Fibonacci_number

*Why did the programmer quit his job?
Because he didn't get arrays.*

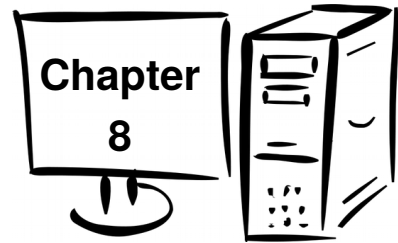

8.0 Addressing Modes

This chapter provides some basic information regarding addressing modes and the associated address manipulations on the x86-64 architecture.

The addressing modes are the supported methods for accessing a value in memory using the address of a data item being accessed (read or written). This might include the name of a variable or the location in an array.

The basic addressing modes are:

- Register
- Immediate
- Memory

Each of these modes is described with examples in the following sections. Additionally, a simple example for accessing an array is presented.

8.1 Addresses and Values

On a 64-bit architecture, addresses require 64-bits.

As noted in the previous chapter, the only way to access memory is with the brackets ([]s). Omitting the brackets will not access memory and instead obtain the address of the item. For example:

```
mov    rax, qword [var1]    ; value of var1 in rax
mov    rax, var1           ; address of var1 in rax
```

Since omitting the brackets is not an error, the assembler will not generate error messages or warnings.

Chapter 8.0 ◀ Addressing Modes

When accessing memory, in many cases the operand size clear. For example, the instruction

```
mov eax, [rbx]
```

moves a double-word from memory. However, for some instructions the size can be ambiguous. For example,

```
inc [rbx] ; error
```

is ambiguous since it is not clear if the memory being accessed is a byte, word, or double-word. In such a case, operand size must be specified with either the *byte*, *word*, or *dword*, *qword* size qualifier. For example,

```
inc byte [rbx]  
inc word [rbx]  
inc dword [rbx]
```

each instruction requires the size specification in order to be clear and legal.

8.1.1 Register Mode Addressing

Register mode addressing means that the operand is a CPU register (**eax**, **ebx**, etc.). For example:

```
mov    eax, ebx
```

Both **eax** and **ebx** are in register mode addressing.

8.1.2 Immediate Mode Addressing

Immediate mode addressing means that the operand is an immediate value. For example:

```
mov eax, 123
```

The destination operand, **eax**, is register mode addressing. The **123** is immediate mode addressing. It should be clear that the destination operand in this example cannot be immediate mode.

8.1.3 Memory Mode Addressing

Memory mode addressing means that the operand is a location in memory (accessed via an address). This is referred to as *indirection* or *dereferencing*.

The most basic form of memory mode addressing has been used extensively in the previous chapter. Specifically, the instruction:

```
mov rax, qword [qNum]
```

Will access the memory location of the variable *qNum* and retrieve the value stored there. This requires that the CPU wait until the value is retrieved before completing the operation and thus might take slightly longer to complete than a similar operation using an immediate value.

When accessing arrays, a more generalized method is required. Specifically, an address can be placed in a register and indirection performed using the register (instead of the variable name).

For example, assuming the following declaration:

```
lst dd 101, 103, 105, 107
```

The decimal value of 101 is 0x00000065 in hex. The memory picture would be as follows:

| Value | Address | Offset | Index |
|-----------------|----------|----------|---------------|
| 00 | 0x6000ef | lst + 15 | |
| 00 | 0x6000ee | lst + 14 | |
| 00 | 0x6000ed | lst + 13 | |
| 6b | 0x6000ec | lst + 12 | lst[3] |
| 00 | 0x6000eb | lst + 11 | |
| 00 | 0x6000ea | lst + 10 | |
| 00 | 0x6000e9 | lst + 9 | |
| 69 | 0x6000e8 | lst + 8 | lst[2] |
| 00 | 0x6000e7 | lst + 7 | |
| 00 | 0x6000e6 | lst + 6 | |
| 00 | 0x6000e5 | lst + 5 | |
| 67 | 0x6000e4 | lst + 4 | lst[1] |
| 00 | 0x6000e3 | lst + 3 | |
| 00 | 0x6000e2 | lst + 2 | |
| 00 | 0x6000e1 | lst + 1 | |
| lst → 65 | 0x6000e0 | lst + 0 | lst[0] |

Chapter 8.0 ◀ Addressing Modes

The first element of the array could be accessed as follows:

```
mov    eax, dword [list]
```

Another way to access the first element is as follows:

```
mov    rbx, list
mov    eax, dword [rbx]
```

In this example, the starting address, or base address, of the list is placed in **rbx** (first line) and then the value at that address is accessed and placed in the **rax** register (second line). This allows us to easily access other elements in the array.

Recall that memory is “byte addressable”, which means that each address is one byte of information. A double-word variable is 32-bits or 4 bytes so each array element uses 4 bytes of memory. As such, the next element (103) is the starting address (list) plus 4, and the next element (105) is the starting address (list) 8.

Increasing the offset by 4 for each successive element. A list of bytes would increase by 1, a list of word would increase by 2, a list of double-words would increase by 4, and a list of quadwords would increase by 8.

The offset is the amount added to the base address. The index is the array element number as used in a high-level language.

There are several ways to access the array elements. One is to use a base address and add a displacement. For example, given the initializations:

```
mov    rbx, list
mov    rsi, 8
```

Each of the following instructions access the third element (105 in the above list).

```
mov    eax, dword [list+8]
mov    eax, dword [rbx+8]
mov    eax, dword [rbx+rsi]
```

In each case, the starting address plus 8 was accessed and the value of 105 placed in the **eax** register. The displacement is added and the memory location accessed while none of the source operand registers (**rbx**, **rsi**) are altered. The specific method used is up to the programmer.

In addition, the displacement may be computed in more complex ways.

The general format of memory addressing is as follows:

$$[\text{baseAddr} + (\text{indexReg} * \text{scaleValue}) + \text{displacement}]$$

Where *baseAddr* is a register or a variable name. The *indexReg* must be a register. The *scaleValue* is an immediate value of 1, 2, 4, 8 (1 is legal, but not useful). The *displacement* must be an immediate value. The total represents a 64-bit address.

Elements may be used in any combination, but must be legal and result in a valid address.

Some example of memory addressing for the source operand are as follows:

```
mov    eax, dword [var1]
mov    rax, qword [rbx+rsi]
mov    ax, word [lst+4]
mov    bx, word [lst+rdx+2]
mov    rcx, qword [lst+(rsi*8)]
mov    al, byte [buff-1+rcx]
mov    eax, dword [rbx+(rsi*4)+16]
```

For example, to access the 3rd element of the previously defined double-word array (which is index 2 since index's start at 0):

```
mov    rsi, 2                ; index=2
mov    eax, dword [list+rsi*4] ; get lst[2]
```

Since addresses are always *qword* (on a 64-bit architecture), a 64-bit register is used for the memory mode addressing (even when accessing double-word values). This allows a register to be used more like an array index (from a high-level language).

For example, the memory operand, `[lst+rsi*4]`, is analogous to `lst[rsi]` from a high-level language. The `rsi` register is multiplied by the data size (4 in this example since each element is 4 bytes).

8.2 Example Program, List Summation

The following example program will sum the numbers in a list.

```
; Simple example to the sum and average for
; a list of numbers.

; *****
```

Chapter 8.0 ◀ Addressing Modes

```
; Data declarations

section    .data

; -----
; Define constants

EXIT_SUCCESS    equ 0           ; successful operation
SYS_exit        equ 60          ; call code for terminate

; -----
; Define Data.

section      .data
    lst      dd      1002, 1004, 1006, 1008, 10010
    len      dd      5
    sum      dd      0

; *****
section      .text
global _start
_start:

; -----
; Summation loop.

    mov      ecx, dword [len]      ; get length value
    mov      rsi, 0                ; index=0

sumLoop:
    mov      eax, dword [lst+(rsi*4)] ; get lst[rsi]
    add      dword [sum], eax        ; update sum
    inc      rsi                    ; next item
    loop     sumLoop

; -----
; Done, terminate program.

last:
    mov      rax, SYS_exit          ; call code for exit
    mov      rdi, EXIT_SUCCESS      ; exit with success
    syscall
```

The `()`'s within the `[]`'s are not required and added only for clarity. As such, the `[lst+(rsi*4)]`, is exactly the same as `[lst+rsi*4]`.

8.3 Example Program, Pyramid Areas and Volumes

This example is a simple assembly language program to calculate some geometric information for a each square pyramid in a series of square pyramids. Specifically, the program will find the lateral total surface area (including the base) and volume of each square pyramid in a set of square pyramids.

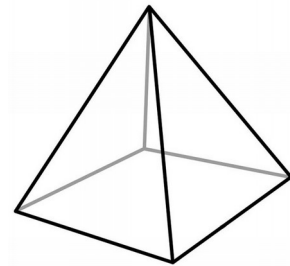

Once the values are computed, the program finds the minimum, maximum, sum, and average for the total surface areas and volumes.

All data are unsigned values (i.e., uses `mul` and `div`, not `imul` or `idiv`).

This basic approach used in this example is the loop to calculate the surface areas and volumes arrays. A second loop is used to find the sum, minimum, and maximum for each array. To find the minimum and maximum values, the minimum and maximum variables are each initialized to the first value in the list. Then, every element in the list is compared to the current minimum and maximum. If the current value from the list is less than the current minimum, the minimum is set to the current value (over-writing the previous value). When all values have been checked, the minimum will represent the true minimum from the list. If the current value from the list is more than the current maximum, the maximum is set to the current value (over-writing the previous value). When all values have been checked, the maximum will represent the true maximum from the list.

```
; Example assembly language program to calculate the
; geometric information for each square pyramid in
; a series of square pyramids.

; The program calculates the total surface area
; and volume of each square pyramid.

; Once the values are computed, the program finds
; the minimum, maximum, sum, and average for the
; total surface areas and volumes.
```

Chapter 8.0 ◀ Addressing Modes

```

; -----
;   Formulas:
;   totalSurfaceAreas(n) = aSides(n) *
;                           (2*aSides(n)*sSides(n))
;   volumes(n) = (aSides(n)^2 * heights(n)) / 3

; *****

section    .data

; -----
;   Define constants

EXIT_SUCCESS    equ    0           ; successful operation
SYS_exit        equ    60          ; call code for terminate

; -----
;   Provided Data

aSides        db    10,    14,    13,    37,    54
               db    31,    13,    20,    61,    36
               db    14,    53,    44,    19,    42
               db    27,    41,    53,    62,    10
               db    19,    18,    14,    10,    15
               db    15,    11,    22,    33,    70
               db    15,    23,    15,    63,    26
               db    24,    33,    10,    61,    15
               db    14,    34,    13,    71,    81
               db    38,    13,    29,    17,    93

sSides        dw    1233,  1114,  1773,  1131,  1675
               dw    1164,  1973,  1974,  1123,  1156
               dw    1344,  1752,  1973,  1142,  1456
               dw    1165,  1754,  1273,  1175,  1546
               dw    1153,  1673,  1453,  1567,  1535
               dw    1144,  1579,  1764,  1567,  1334
               dw    1456,  1563,  1564,  1753,  1165
               dw    1646,  1862,  1457,  1167,  1534
               dw    1867,  1864,  1757,  1755,  1453
               dw    1863,  1673,  1275,  1756,  1353

```

```

heights    dd 14145, 11134, 15123, 15123, 14123
           dd 18454, 15454, 12156, 12164, 12542
           dd 18453, 18453, 11184, 15142, 12354
           dd 14564, 14134, 12156, 12344, 13142
           dd 11153, 18543, 17156, 12352, 15434
           dd 18455, 14134, 12123, 15324, 13453
           dd 11134, 14134, 15156, 15234, 17142
           dd 19567, 14134, 12134, 17546, 16123
           dd 11134, 14134, 14576, 15457, 17142
           dd 13153, 11153, 12184, 14142, 17134

length     dd 50

taMin      dd 0
taMax      dd 0
taSum      dd 0
taAve      dd 0

volMin     dd 0
volMax     dd 0
volSum     dd 0
volAve     dd 0

; -----
; Additional variables

ddTwo      dd 2
ddThree    dd 3

; -----
; Uninitialized data

section    .bss
totalAreas    resd    50
volumes      resd    50

; *****

section    .text
global    _start
_start:

```

Chapter 8.0 ◀ Addressing Modes

```
; Calculate volume, lateral and total surface areas

    mov     ecx, dword [length]           ; length counter
    mov     rsi, 0                       ; index

calculationLoop:

;   totalAreas(n) = aSides(n) * (2*aSides(n)*sSides(n))

    movzx  r8d, byte [aSides+rsi]        ; aSides[i]
    movzx  r9d, word [sSides+rsi*2]     ; sSides[i]
    mov    eax, r8d
    mul    dword [ddTwo]
    mul    r9d
    mul    r8d
    mov    dword [totalAreas+rsi*4], eax

;   volumes(n) = (aSides(n)^2 * heights(n)) / 3

    movzx  eax, byte [aSides+rsi]
    mul    eax
    mul    dword [heights+rsi*4]
    div   dword [ddThree]
    mov    dword [volumes+rsi*4], eax

    inc    rsi
    loop   calculationLoop

; -----
; Find min, max, sum, and average for the total
; areas and volumes.

    mov    eax, dword [totalAreas]
    mov    dword [taMin], eax
    mov    dword [taMax], eax

    mov    eax, dword [volumes]
    mov    dword [volMin], eax
    mov    dword [volMax], eax

    mov    dword [taSum], 0
    mov    dword [volSum], 0
```



```

    mov     ecx, dword [length]
    mov     rsi, 0

statsLoop:
    mov     eax, dword [totalAreas+rsi*4]
    add     dword [taSum], eax

    cmp     eax, dword [taMin]
    jae     notNewTaMin
    mov     dword [taMin], eax

notNewTaMin:
    cmp     eax, dword [taMax]
    jbe     notNewTaMax
    mov     dword [taMax], eax

notNewTaMax:
    mov     eax, dword [volumes+rsi*4]
    add     dword [volSum], eax
    cmp     eax, dword [volMin]
    jae     notNewVolMin
    mov     dword [volMin], eax

notNewVolMin:
    cmp     eax, dword [volMax]
    jbe     notNewVolMax
    mov     dword [volMax], eax
notNewVolMax:

    inc     rsi
    loop   statsLoop

; -----
; Calculate averages.

    mov     eax, dword [taSum]
    mov     edx, 0
    div     dword [length]
    mov     dword [taAve], eax

    mov     eax, dword [volSum]

```

Chapter 8.0 ◀ Addressing Modes

```
    mov     edx, 0
    div     dword [length]
    mov     dword [volAve], eax

; -----
; Done, terminate program.

last:
    mov     rax, SYS_exit           ; call code for exit
    mov     rdi, EXIT_SUCCESS      ; exit with success
    syscall
```

This is one example. There are multiple other valid approaches to solving this problem.

8.4 Exercises

Below are some quiz questions and suggested projects based on this chapter.

8.4.1 Quiz Questions

Below are some quiz questions based on this chapter.

- 1) Explain the difference between the following two instructions:
 1. `mov rdx, qword [qVar1]`
 2. `mov rdx, qVar1`
- 2) What is the address mode of the source operand for each of the instructions listed below. Respond with *Register*, *Immediate*, *Memory*, or *Illegal Instruction*.

Note, `mov <dest>, <source>`

```
    mov     ebx, 14

    mov     ecx, dword [rbx]

    mov     byte [rbx+4], 10

    mov     10, rcx

    mov     dl, ah
```

```

mov    ax, word [rsi+4]

mov    cx, word [rbx+rsi]

mov    ax, byte [rbx]

```

- 3) Given the following variable declarations and code fragment:

```

ans1   dd    7

mov    rax, 3
mov    rbx, ans1
add    eax, dword [rbx]

```

What would be in the **eax** register after execution? Show answer in hex, full register size.

- 4) Given the following variable declarations and code fragment:

```

list1   dd    2, 3, 4, 5, 6, 7

mov    rbx, list1
add    rbx, 4
mov    eax, dword [rbx]
mov    edx, dword [list1]

```

What would be in the **eax** and **edx** registers after execution? Show answer in hex, full register size.

- 5) Given the following variable declarations and code fragment:

```

lst     dd    2, 3, 5, 7, 9

        mov    rsi, 4
        mov    eax, 1
        mov    rcx, 2
lp:     add    eax, dword [lst+rsi]
        add    rsi, 4
        loop  lp
        mov    ebx, dword [lst]

```

Chapter 8.0 ◀ Addressing Modes

What would be in the **eax**, **ebx**, **rcx**, and **rsi** registers after execution? Show answer in hex, full register size. *Note*, pay close attention to the register sizes (32-bit vs. 64-bit).

- 6) Given the following variable declarations and code fragment:

```
list    dd    8, 6, 4, 2, 1, 0

        mov    rbx, list
        mov    rsi, 1
        mov    rcx, 3
        mov    edx, dword [rbx]
lp:     mov    eax, dword [list+rsi*4]
        inc    rsi
        loop  lp
        imul  dword [list]
```

What would be in the **eax**, **edx**, **rcx**, and **rsi** registers after execution? Show answer in hex, full register size. *Note*, pay close attention to the register sizes (32-bit vs. 64-bit).

- 7) Given the following variable declarations and code fragment:

```
list    dd    8, 7, 6, 5, 4, 3, 2, 1, 0

        mov    rbx, list
        mov    rsi, 0
        mov    rcx, 3
        mov    edx, dword [rbx]
lp:     add    eax, dword [list+rsi*4]
        inc    rsi
        loop  lp
        cdq
        idiv  dword [list]
```

What would be in the **eax**, **edx**, **rcx**, and **rsi** registers after execution? Show answer in hex, full register size. *Note*, pay close attention to the register sizes (32-bit vs. 64-bit).

8) Given the following variable declarations and code fragment:

```

list      dd    2, 7, 4, 5, 6, 3

          mov    rbx, list
          mov    rsi, 1
          mov    rcx, 2
          mov    eax, 0
          mov    edx, dword [rbx+4]
lp:       add    eax, dword [rbx+rsi*4]
          add    rsi, 2
          loop   lp
          imul   dword [rbx]

```

What would be in the **eax**, **edx**, **rcx**, and **rsi** registers after execution? Show answer in hex, full register size. *Note*, pay close attention to the register sizes (32-bit vs. 64-bit).

8.4.2 Suggested Projects

Below are some suggested projects based on this chapter.

- 1) Implement the example program to sum a list of numbers. Use the debugger to execute the program and display the final results. Create a debugger input file to show the results.
- 2) Update the example program from the previous question to find the maximum, minimum, and average for the list of numbers. Use the debugger to execute the program and display the final results. Create a debugger input file to show the results.
- 3) Implement the example program to compute the lateral total surface area (including the base) and volume of each square pyramid in a set of square pyramids. Once the values are computed, the program finds the minimum, maximum, sum, and average for the total surface areas and volumes. Use the debugger to execute the program and display the final results. Create a debugger input file to show the results.
- 4) Write an assembly language program to find the minimum, middle value, maximum, sum, and integer average of a list of numbers. Additionally, the program should also find the sum, count, and integer average for the negative numbers. The program should also find the sum, count, and integer average for

the numbers that are evenly divisible by 3. Unlike the median, the 'middle value' does not require the numbers to be sorted. *Note*, for an odd number of items, the middle value is defined as the middle value. For an even number of values, it is the integer average of the two middle values. Assume all data is unsigned. Use the debugger to execute the program and display the final results. Create a debugger input file to show the results.

- 5) Repeat the previous program using signed values and signed operations. Use the debugger to execute the program and display the final results. Create a debugger input file to show the results.
- 6) Create a program to sort a list of numbers. Use the following bubble sort³⁸ algorithm:

```

for ( i = (len-1) to 0 ) {
    swapped = false
    for ( j = 0 to i-1 )
        if ( lst(j) > lst(j+1) ) {
            tmp = lst(j)
            lst(j) = lst(j+1)
            lst(j+1) = tmp
            swapped = true
        }
    if ( swapped = false ) exit
}

```

Use the debugger to execute the program and display the final results. Create a debugger input file to show the results.

³⁸ For more information, refer to: http://en.wikipedia.org/wiki/Bubble_sort

A programmer is heading out to the grocery store, and is asked to "get a gallon of milk, and if they have eggs, get a dozen." He returns with 12 gallons of milk.

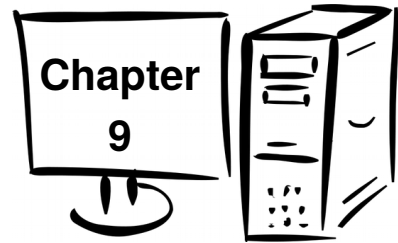

9.0 Process Stack

In a computer, a stack is a type of data structure where items are added and then removed from the stack in reverse order. That is, the most recently added item is the very first one that is removed. This is often referred to as Last-In, First-Out (LIFO).

A stack is heavily used in programming for the storage of information during procedure or function calls. The following chapter provides information and examples regarding the stack.

Adding an item to a stack is referred to as a **push** or push operation. Removing an item from a stack is referred to as a **pop** or pop operation.

It is expected that the reader will be familiar with the general concept of a stack.

9.1 Stack Example

To demonstrate the general usage of the stack, given an array, **a = {7, 19, 37}**, consider the operations:

```
push  a[0]
push  a[1]
push  a[2]
```

Followed by the operations:

```
pop   a[0]
pop   a[1]
pop   a[2]
```

The initial push will push the 7, followed by the 19, and finally the 37. Since the stack is last-in, first-out, the first item popped off the stack will be the last item pushed, or 37 in this example. The 37 is placed in the first element of the array (over-writing the 7). As this continues, the order of the array elements is reversed.

The following diagram shows the progress and the results.

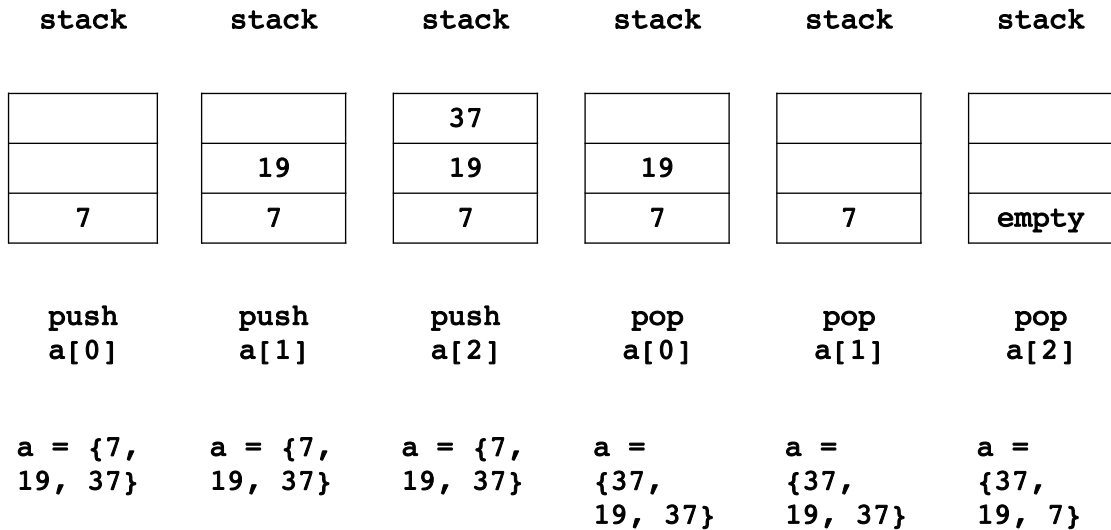

The following sections provide more detail regarding the stack implementation and applicable stack operations and instructions.

9.2 Stack Instructions

A push operation puts things onto the stack, and a pop operation takes things off the stack. The format for these commands is:

```
push    <operand64>
pop     <operand64>
```

The operand can be a register or memory, but an immediate is not allowed. In general, push and pop operations will push the architecture size. Since the architecture is 64-bit, we will push and pop quadwords.

The stack is implemented in reverse in memory. Refer to the following sections for a detailed explanation of why.

The stack instructions are summarized as follows:

| Instruction | Explanation |
|--------------------|--|
| push <op64> | Push the 64-bit operand on the stack. First, adjusts rsp accordingly (rsp-8) and then copy the operand to [rsp]. The operand may not be an immediate value. Operand is not changed. |
| Examples: | <pre> push rax push qword [qVal] ; value push qVal ; address </pre> |
| pop <op64> | Pop the 64-bit operand from the stack. Adjusts rsp accordingly (rsp+8). The operand may not be an immediate value. Operand is overwritten. |
| Examples: | <pre> pop rax pop qword [qVal] pop rsi </pre> |

If more than 64-bits must be pushed, multiple push operations would be required. While it is possible to push and pop operands less than 64-bits, it is not recommended.

A more complete list of the instructions is located in Appendix B.

9.3 Stack Implementation

The **rsp** register is used to point to the current top of stack in memory. In this architecture, as with most, the stack is implemented growing downward in memory.

9.3.1 Stack Layout

As noted in Chapter 2, Architecture, the general memory layout for a program is as follows:

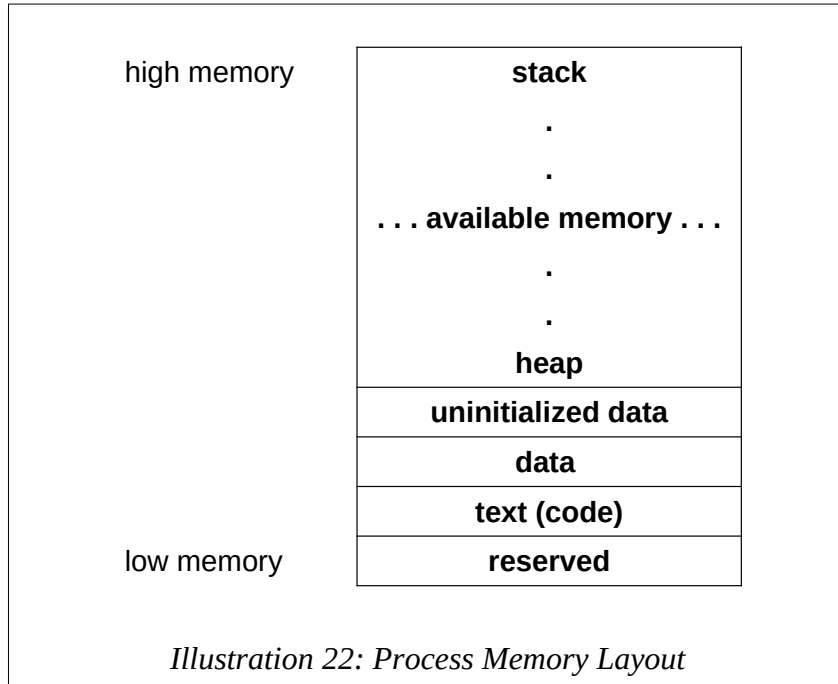

The heap is where dynamically allocated data will be placed (if requested). For example, items allocated with the C++ **new** operator or the C **malloc()** system call. As dynamically allocated data is created (at run-time), the heap typically grows upward. However, the stack starts in high memory and grows downward. The stack is used to temporarily store information such as call frames for function calls. A large program or a recursive function may use a significant amount of stack space.

As the heap and stack expand, they grow toward each other. This is done to ensure the most effective overall use of memory.

A program (Process A) that uses a significant amount of stack space and a minimal amount of heap space will function. A program (Process B) that uses a minimal amount of stack space and a very large amount of heap space will also function.

For example:

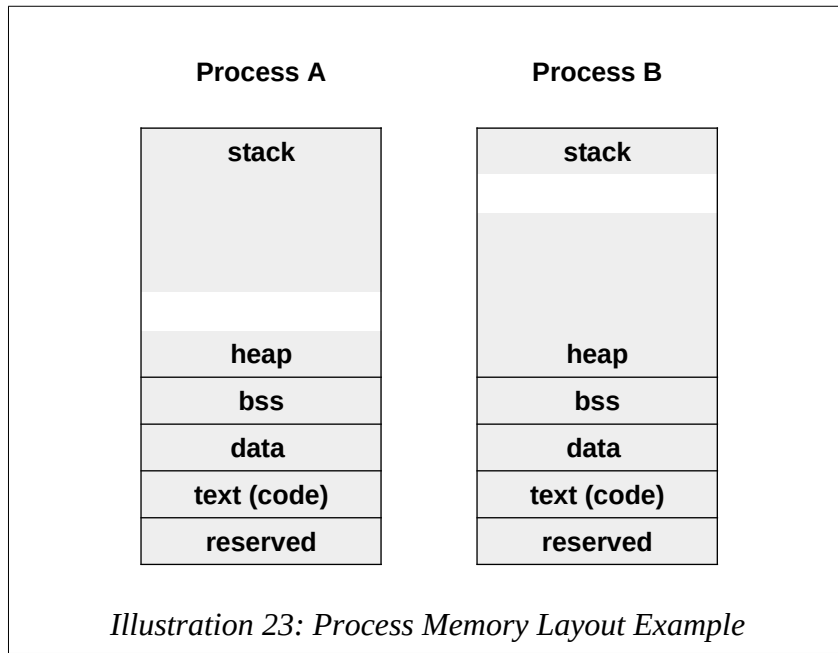

Of course, if the stack and heap meet, the program will crash. If that occurs, there is no memory available.

9.3.2 Stack Operations

The basic stack operations of push and pop adjust the stack pointer register, **rsp**, during their operation.

For a push operation:

1. The **rsp** register is decreased by 8 (1 quadword).
2. The operand is copied to the stack at **[rsp]**.

The operand is not altered. The order of these operations is important.

For a pop operation:

1. The current top of the stack, at **[rsp]**, is copied into the operand.
2. The **rsp** register is increased by 8 (1 quadword).

The order of these operations is the exact reverse of the push. The item popped is not

The layout shows the architecture is little-endian in that the least significant byte is placed into the lowest memory location.

9.4 Stack Example

The following is an example program to use the stack to reverse a list of quadwords in place. Specifically, each value in a quadword array is placed on the stack in the first loop. In the second loop, each element is removed from the stack and placed back into the array (over-writing) the previous value.

```

; Simple example demonstrating basic stack operations.

; Reverse a list of numbers - in place.
; Method: Put each number on stack, then pop each number
;         back off, and then put back into memory.

; *****
; Data declarations

section    .data

; -----
; Define constants

EXIT_SUCCESS    equ    0        ; successful operation
SYS_exit        equ    60       ; call code for terminate

; -----
; Define Data.

numbers        dq    121, 122, 123, 124, 125
len            dq    5

; *****
section    .text
global _start
_start:

; Loop to put numbers on stack.

    mov     rcx, qword [len]

```

Chapter 9.0 ◀ Process Stack

```
    mov    rbx, numbers
    mov    r12, 0
    mov    rax, 0

pushLoop:
    push  qword [rbx+r12*8]
    inc   r12
    loop  pushLoop

; -----
; All the numbers are on stack (in reverse order).
; Loop to get them back off.  Put them back into
; the original list...

    mov    rcx, qword [len]
    mov    rbx, numbers
    mov    r12, 0
popLoop:
    pop   rax
    mov   qword [rbx+r12*8], rax
    inc   r12
    loop  popLoop

; -----
; Done, terminate program.

last:
    mov    rax, SYS_exit           ; call code for exit
    mov    rdi, EXIT_SUCCESS      ; exit with success
    syscall
```

There are other ways to accomplish this function (reversing a list), however this is meant to demonstrate the stack operations.

9.5 Exercises

Below are some quiz questions and suggested projects based on this chapter.

9.5.1 Quiz Questions

Below are some quiz questions based on this chapter.

- 1) Which register refers to the top of the stack?

- 2) What happens as a result of a **push rax** instruction (two things)?
- 3) How many **bytes** of data does the **pop rax** instruction remove from the stack?
- 4) Given the following code fragment:

```

mov r10, 1
mov r11, 2
mov r12, 3
push r10
push r11
push r12
pop r10
pop r11
pop r12

```

What would be in the **r10**, **r11**, and **r12** registers after execution? Show answer in hex, full register size.

- 5) Given the following variable declarations and code fragment:

```

lst    dq    1, 3, 5, 7, 9

        mov    rsi, 0
        mov    rcx, 5
lp1:    push   qword [lst+rsi*8]
        inc    rsi
        loop  lp1
        mov    rsi, 0
        mov    rcx, 5
lp2:    pop    qword [lst+rsi*8]
        inc    rsi
        loop  lp2
        mov    rbx, qword [lst]

```

Explain what would be **result** of the code (after execution)?

- 6) Provide one advantage to the stack growing downward in memory.

9.5.2 Suggested Projects

Below are some suggested projects based on this chapter.

- 1) Implement the example program to reverse a list of numbers. Use the debugger to execute the program and display the final results. Create a debugger input file to show the results.
- 2) Create a program to determine if a NULL terminated string representing a word is a palindrome³⁹. A palindrome is word that reads the same forward or backwards. For example, “anna”, “civic”, “hannah”, “kayak”, and “madam” are palindromes. This can be accomplished by pushing the characters on the stack one at a time and then comparing the stack items to the string starting from the beginning. Use the debugger to execute the program and display the final results. Create a debugger input file to show the results.
- 3) Update the previous program to test if a phrase is a palindrome. The general approach using the stack is the same, however spaces and punctuation must be skipped. For example, “A man, a plan, a canal – Panama!” is a palindrome. The program must ignore the comma, dash, and exclamation point. Use the debugger to execute the program and display the final results. Create a debugger input file to show the results.

39 For more information, refer to: <http://en.wikipedia.org/wiki/Palindrome>

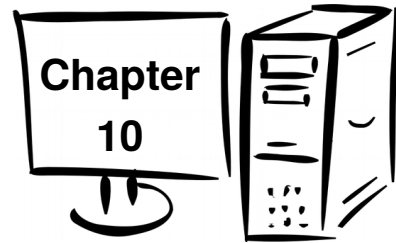

10.0 Program Development

Writing or developing programs is easier when following a clear methodology. The main steps in the methodology are:

- Understand the Problem
- Create the Algorithm
- Implement the Program
- Test/Debug the Program

To help demonstrate this process in detail, these steps will be applied to a simple example problem in the following sections.

10.1 Understand the Problem

Before attempting to create a solution, it is important to fully understand the problem. Ensuring a complete understanding of the problem can help reduce errors and save time and effort. The first step is to understand what is required, especially the applicable input information and expected results or output.

Consider the problem of converting a single integer number into a string or series of characters representing that integer. To be clear, an integer can be used for numeric calculations, but cannot be displayed to the console (as it is). A string can be displayed to the console but not used in numeric calculations.

For this example, only unsigned (positive only) values will be considered. The small extra effort to address signed values is left to the reader as an exercise.

As an unsigned double-word integer, the numeric value 1498_{10} would be represented as $0x000005DA$ in hex (double-word sized). The integer number 1498_{10} ($0x000005DA$) would be represented by the string “1”, “4”, “9”, “8” with a NULL termination. This would require a total of 5 bytes since there is no sign or leading spaces required for this

specific example. As such, the string “1498” would be represented as follows:

| | | | | | |
|-----------------------|------|------|------|------|------|
| Character | “1” | “4” | “9” | “8” | NULL |
| ASCII Value (decimal) | 49 | 52 | 57 | 56 | 0 |
| ASCII Value (hex) | 0x31 | 0x34 | 0x39 | 0x38 | 0x0 |

The goal is to convert the single integer number into the appropriate series of characters to form a NULL terminated string.

10.2 Create the Algorithm

The algorithm is the name for the unambiguous, ordered sequence of steps involved in solving the problem. Once the program is understood, a series of steps can be developed to solve that problem. There can be, and usually are, multiple correct solutions to a given problem.

The process for creating an algorithm can be different for different people. In general, some time should be devoted to thinking about possible solutions. This may involve working on some possible solutions using a scratch piece of paper. Once an approach is selected, that solution can be developed into an algorithm. The algorithm should be written down, reviewed, and refined. The algorithm is then used as the outline of the program.

For example, we will consider the integer to ASCII conversion problem outlined in the previous section. To convert a single digit integer (0-9) into a character, 48_{10} (or “0” or $0x30$) can be added to the integer. For example, $0x01 + 0x30$ is $0x31$ which is the ASCII value of “1”. It should be obvious that this trick will only work for single digit numbers (0-9).

In order to convert a larger integer (≥ 10) into a string, the integer must be broken into its component digits. For example, 123_{10} ($0x7B$) would be 1, 2, and 3. This can be accomplished by repeatedly performing integer division by 10 until a 0 result is obtained.

For example;

$$\frac{123}{10} = 12 \quad \textit{remainder 3}$$

$$\frac{12}{10} = 1 \quad \textit{remainder 2}$$

$$\frac{1}{10} = 0 \quad \textit{remainder 1}$$

As can be seen, the remainder represents the individual digits. However, they are obtained in reverse order. To address this, the program can push the remainder and, when done dividing, pop the remainders and convert to ASCII and store in a string (which is an array of bytes).

This process forms the basis for the algorithm. It should be noted, that there are many ways to develop this algorithm. One such approach is shown as follows:

```

; Part A - Successive division
;   digitCount = 0
;   get integer
;   divideLoop:
;     divide number by 10
;     push remainder
;     increment digitCount
;     if (result > 0) goto divideLoop

; Part B - Convert remainders and store
;   get starting address of string (array of bytes)
;   idx = 0
;   popLoop:
;     pop intDigit
;     charDigit = intDigit + "0" (0x030)
;     string[idx] = charDigit
;     increment idx
;     decrement digitCount
;     if (digitCount > 0) goto popLoop
;     string[idx] = NULL

```

The algorithm steps are shown as program comments for convenience. The algorithm is typically started on paper and then more formally written in pseudo-code as shown above. In the unlikely event the program does not work the first time, the comments are the primary debugging checklist.

Some programmers skip the comments and will end up spending much more time debugging. The commenting represents the algorithm and the code is the implementation of that algorithm.

10.3 Implement the Program

Based on the algorithm, a program can be developed and implemented. The algorithm is expanded and the code added based on the steps outlined in the algorithm. This allows the programmer to focus on the specific issues for the current section being coded including the data types and data sizes. This example addresses only unsigned data so the unsigned divide (DIV, not IDIV) is used. Since the integer is a double-word, it must be converted into a quadword for the division. However, the result and the remainder after division will also be a double-words. Since the stack is quadwords, the entire quadword register will be pushed. The upper order portion of the register will not be accessed, so its contents are not relevant.

One possible implementation of the algorithm is as follows:

```

; Simple example program to convert an
; integer into an ASCII string.

; *****
; Data declarations

section    .data

; -----
; Define constants

NULL      equ    0
EXIT_SUCCESS equ    0           ; successful operation
SYS_exit  equ    60           ; code for terminate

; -----
; Define Data.

```

```

section    .data
intNum     dd      1498

section    .bss
strNum     resb   10

; *****

section    .text
global    _start
_start:

; Convert an integer to an ASCII string.

; -----
; Part A - Successive division

    mov     eax, dword [intNum]      ; get integer
    mov     rcx, 0                   ; digitCount = 0
    mov     ebx, 10                  ; set for dividing by 10

divideLoop:
    mov     edx, 0
    div     ebx                       ; divide number by 10

    push   rdx                       ; push remainder
    inc    rcx                       ; increment digitCount

    cmp     eax, 0                   ; if (result > 0)
    jne    divideLoop               ; goto dvideLoop

; -----
; Part B - Convert remainders and store

    mov     rbx, strNum              ; get addr of string
    mov     rdi, 0                   ; idx = 0

popLoop:
    pop    rax                       ; pop intDigit

    add    al, "0"                   ; char = int + "0"

```

```

    mov    byte [rbx+rdi], al           ; string[idx] = char
    inc   rdi                          ; increment idx
    loop  popLoop                      ; if (digitCount > 0)
                                       ; goto popLoop

    mov    byte [rbx+rdi], NULL        ; string[idx] = NULL

; -----
; Done, terminate program.

last:
    mov    rax, SYS_exit               ; call code for exit
    mov    rdi, EXIT_SUCCESS          ; exit with success
    syscall

```

There are many different valid implementations for this algorithm. The program should be assembled to address any typos or syntax errors.

10.4 Test/Debug the Program

Once the program is written, testing should be performed to ensure that the program works. The testing will be based on the specific parameters of the program.

In this case, the program can be executed using the debugger and stopped near the end of the program (e.g., at the label “last” in this example). After starting the debugger with **ddd**, the command **b last** and **run** can be entered which will run the program up to, but not executing the line referenced by the label “last”. The resulting string, **strNum** can be viewed in the debugger with **x/s &strNum** will display the string address and the contents which should be “1498”. For example;

```

(gdb) x/s &strNum
0x600104: "1498"

```

If the string is not displayed properly, it might be worth checking each character of the five (5) byte array with the **x/5cb &chrNum** debugger command. The output will show the address of the string followed by both the decimal and ASCII representation.

For example;

```

(gdb) x/5cb &strNum
0x600104: 49 '1' 52 '4' 57 '9' 56 '8' 0 '\000'

```

The format of this this output can be confusing initially.

If the correct output is not provided, the programmer will need to debug the code. For this example, there are two main steps; successive division and conversion/storing the remainders. The second step requires the first step to work, so the first step should be verified. This can be done by using the debugger to focus only on the first section. In this example, the first step should iterate exactly 4 times, so **rcx** should be 4. Additionally, 8, 9, 4, and 1 should be pushed on the stack in that order. This is easily verified in the debugger by looking at the register contents of **rdx** when it is pushed or by viewing the top 4 entries in the stack.

If that section works, the second section can be verified. Here, the values 1, 4, 9, and 8 should be coming off the stack (in that order). If so, the integer is converted into a character by adding "0" (0x30) and that stored in the string, one character at a time. The string can be viewed character by character to see if they are being entered into the string correctly.

In this manner, the problem can be narrowed down fairly quickly. Efficient debugging is a critical skill and must be honed by practice.

Refer to the Chapter 6, DDD Debugger for additional information on specific debugger commands.

10.5 Error Terminology

In case the program does not work, it helps to understand some basic terminology about where or what the error might be. Using the correct terminology ensures that you can communicate effectively about the problem with others.

10.5.1 Assembler Error

Assembler errors are generated when the program is assembled. This means that the assembler does not understand one or more of the instructions. The assembler will provide a list of errors and the line number the of each error. It is recommended to address the errors from the top down. Resolving an error at the top can clear multiple errors further down.

Typical assembler errors include misspelling an instruction and/or omitting a variable declaration.

10.5.2 Run-time Error

A run-time error is something that causes the program to crash.

10.5.3 Logic Error

A logic error is when the program executes, but does not produce the correct result. For example, coding a provided formula incorrectly or attempting to compute the average of a series of numbers before calculating the sum.

If the program has a logic error, one way to find the error is to display intermediate values. Further information will be provided in later chapters regarding advice on finding logic errors.

10.6 Exercises

Below are some quiz questions and suggested projects based on this chapter.

10.6.1 Quiz Questions

Below are some quiz questions based on this chapter.

- 1) What is an algorithm?
- 2) What are the four main steps in algorithm development?
- 3) Are the four main steps in algorithm development applicable only to assembly language programming?
- 4) What type of error, if any, occurs if the one operand multiply instruction uses an immediate value operand? Respond with assemble-time or run-time.
- 5) If an assembly language instruction is spelled incorrectly (e.g., “mv” instead of “mov”), when will the error be found? Respond with assemble-time or run-time.
- 6) If a label is referenced, but not defined, when will the error be found? Respond with assemble-time or run-time.
- 7) If a program performing a series of divides on values in an array divides by 0, when will the error be found? Respond with assemble-time or run-time.

10.6.2 Suggested Projects

Below are some suggested projects based on this chapter.

- 1) Implement the example program to convert an integer into a string. Change the original integer to a different value. Use the debugger to execute the program and display the final results. Create a debugger input file to show the results.

- 2) Update the example program to address signed integers. This will require including a preceding sign, “+” or “-” in the string. For example, -123_{10} (0xFFFFFFFF85) would be “-123” with a NULL termination (total of 5 bytes). Additionally, the signed divide (IDIV, not DIV) and signed conversions (e.g., CDQ) must be used. Use the debugger to execute the program and display the final results. Create a debugger input file to show the results.
- 3) Create a program to convert a string representing a numeric value into an integer. For example, given the NULL terminated string “41275” (a total of 6 bytes), convert the string into a double-word sized integer (0x0000A13B). You may assume the string and resulting integer is unsigned. Use the debugger to execute the program and display the final results. Create a debugger input file to show the results.
- 4) Update the previous program to address strings with a preceding sign (“+” or “-”). This will require including a sign, “+” or “-” in the string. You must ensure the final string is NULL terminated. You may assume the input strings are valid. Use the debugger to execute the program and display the final results. Create a debugger input file to show the results.
- 5) Update the previous program to convert strings into integers to include error checking on the input string. Specifically, the sign must be valid and be the first character in the string, each digit must be between “0” and “9”, and the string NULL terminated. For example, the string “-321” is valid while “+32” and “+1R3” are both invalid. Use the debugger to execute the program and display the final results. Create a debugger input file to show the results.

*Why did C++ decide not to go out with C?
Because C has no class.*

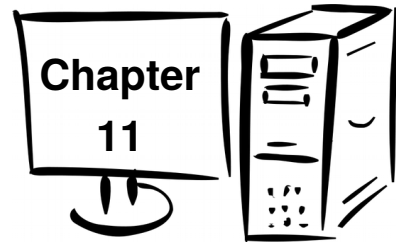

11.0 Macros

An assembly language macro is a predefined set of instructions that can easily be inserted wherever needed. Once defined, the macro can be used as many times as necessary. It is useful when the same set of code must be utilized numerous times. A macro can be useful to reduce the amount of coding, streamline programs, and reduce errors from repetitive coding.

The assembler contains a powerful macro processor, which supports conditional assembly, multi-level file inclusion, and two forms of macros (single-line and multi-line), and a 'context stack' mechanism for extra macro power.

Before using a macro, it must be defined. Macro definitions should be placed in the source file *before* the data and code sections. The macro is used in the text (code) section. The following sections will present a detailed example with the definition and use.

11.1 Single-Line Macros

There are two key types of macros; single-line macros and multi-line macros. Each of these is described in the following sections.

Single-line macros are defined using the **%define** directive. The definitions work in a similar way to C/C++; so you can do things like:

```
%define mulby4(x) shl x, 2
```

And, then use the macro by entering:

```
mulby4 (rax)
```

in the source, which will multiply the contents to the **rax** register by 4 (via shifting two bits).

11.2 Multi-Line Macros

Multi-line macros can include a varying number of lines (including one). The multi-line macros are more useful and the following sections will focus primarily on multi-line macros.

11.2.1 Macro Definition

Before using a multi-line macro, it must first be defined. The general format is as follows:

```
%macro <name> <number of arguments>  
  
    ; [body of macro]  
  
%endmacro
```

The arguments can be referenced within the macro by %<number>, with %1 being the first argument, and %2 the second argument, and so forth.

In order to use labels, the labels within the macro must be prefixing the label name with a %%.

This will ensure that calling the same macro multiple times will use a different label each time. For example, a macro definition for the absolute value function would be as follows:

```
%macro abs 1  
    cmp %1, 0  
    jge %%done  
    neg %1  
%%done:  
  
%endmacro
```

Refer to the sample macro program for a complete example.

11.2.2 Using a Macro

In order to use or “invoke” a macro, it must be placed in the code segment and referred to by name with the appropriate number of arguments.

Given a data declaration as follows:

```
qVar    dq    4
```

Then, to invoke the “abs” macro (twice):

```
mov    eax, -3
abs    eax

abs    qword [qVar]
```

The list file will display the code as follows (for the first invocation):

```
27 00000000 B8FDFFFFFF          mov    eax, -3
28                                abs    eax
29 00000005 3D00000000    <1>  cmp    %1, 0
30 0000000A 7D02          <1>  jge    %%done
31 0000000C F7D8          <1>  neg    %1
32                                <1>  %%done:
```

The macro will be copied from the definition into the code, with the appropriate arguments replaced in the body of the macro, *each* time it is used. The <1> indicates code copied from a macro definition. In both cases, the %1 argument was replaced with the given argument; **eax** in this example.

Macros use more memory, but do not require overhead for transfer of control (like functions).

11.3 Macro Example

The following example program demonstrates the definition and use of a simple macro.

```
; Example Program to demonstrate a simple macro

; *****
; Define the macro
; called with three arguments:
;     aver <1st>, <len>, <ave>

%macro    aver    3
    mov    eax, 0
    mov    ecx, dword [%2]          ; length
```

Chapter 11.0 ◀ Macros

```
    mov    r12, 0
    lea   rbx, [%1]

%%sumLoop:
    add   eax, dword [rbx+r12*4]    ; get list[n]
    inc   r12
    loop  %%sumLoop

    cdq
    idiv  dword [%2]
    mov   dword [%3], eax

%endmacro

; *****
; Data declarations

section    .data

; -----
; Define constants

EXIT_SUCCESS    equ    0                ; success code
SYS_exit        equ    60               ; code for terminate

; Define Data.

section    .data
list1     dd    4, 5, 2, -3, 1
len1      dd    5
ave1      dd    0

list2     dd    2, 6, 3, -2, 1, 8, 19
len2      dd    7
ave2      dd    0
; *****

section    .text
global _start
_start:
```

```

; -----
; Use the macro in the program

    aver    list1, len1, ave1           ; 1st, data set 1

    aver    list2, len2, ave2           ; 2nd, data set 2

; -----
; Done, terminate program.

last:
    mov rax, SYS_exit                   ; exit
    mov rdi, EXIT_SUCCESS               ; success
    syscall

```

In this example, the macro is invoked twice. Each time the macro is used, it is copied from the definition into the text section. As such, macros typically use more memory.

11.4 Debugging Macros

The code for a macro will not be displayed in the debugger source window. When a macro is working correctly, this is very convenient. However, when debugging macros, the code must be viewable.

In order to see the macro code, display the machine code window (**View** → **Machine Code Window**). In the window, the machine code for the instructions are displayed. The step and next instructions will execute the entire macro. In order to execute the macro instructions, the **stepi** and **nexti** commands must be used.

The code, when viewed, will be the expanded code (as opposed to the original macro's definition).

11.5 Exercises

Below are some quiz questions and suggested projects based on this chapter.

11.5.1 Quiz Questions

Below are some quiz questions based on this chapter.

- 1) Where is the macro definition placed in the assembly language source file?

- 2) When a macro is invoked, how many times is the code placed in the code segment?
- 3) Explain why, in a macro, labels are typically preceded by a %% (double percent sign).
- 4) Explain what might happen if the %% is not included on a label?
- 5) Is it legal to jump to a label that does not include the %%? If not legal, explain why. If legal, explain under what circumstances that might be useful.
- 6) When does the macro argument substitution occur?

11.5.2 Suggested Projects

Below are some suggested projects based on this chapter.

- 1) Implement the example program for a list average macro. Use the debugger to execute the program and display the final results. Create a debugger input file to show the results.
- 2) Update the program from the previous question to include the minimum and maximum values. Use the debugger to execute the program and display the final results. Create a debugger input file to show the results.
- 3) Create a macro to update an existing list by multiple every element by 2. Invoke the macro at least three times of three different data sets. Use the debugger to execute the program and display the final results. Create a debugger input file to show the results.
- 4) Create a macro from the integer to ASCII conversion example from the previous chapter. Invoke the macro at least three times of three different data sets. Use the debugger to execute the program and display the final results. Create a debugger input file to show the results.

*Why do programmers mix up Halloween
and Christmas?
Because 31 Oct = 25 Dec.*

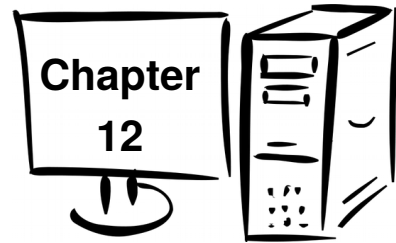

12.0 Functions

Functions and procedures (i.e., void functions), help break-up a program into smaller parts making it easier to code, debug, and maintain. Function calls involve two main actions:

- Linkage
 - Since the function can be called from multiple different places in the code, the function must be able to return to the correct place in which it was originally called.
- Argument Transmission
 - The function must be able to access parameters to operate on or to return results (i.e., access call-by-reference parameters).

The specifics of how each of these actions are accomplished is explained in the following sections.

12.1 Updated Linking Instructions

When writing and debugging functions, it is easier for the C compiler (either GCC or G++) to link the program as the C compiler is aware of the appropriate locations for the various C/C++ libraries.

For example, assuming that the source file is named *example.asm*, the commands to compile, assemble, link, and execute as follows:

```
yasm -g dwarf2 -f elf64 example.asm -l example.lst  
gcc -g -o example example.o
```

Note, Ubuntu 18 will require the **no-pie** option on the gcc command as shown:

```
gcc -g -no-pie -o example example.o
```

This will use the GCC compiler to call the linker, reading the *example.o* object file and creating the *example* executable file. The “-g” option includes the debugging information in the executable file in the usual manner. The file names can be changed as desired.

12.2 Debugger Commands

When using the debugger to debug programs with functions, a review of the *step* and *next* debugger commands may be helpful.

12.2.1 Debugger Command, *next*

With respect to a function call, the debugger *next* command will execute the entire function and go to the next line. When debugging functions, this is useful to quickly execute the entire function and then just verify the results. It will not display any of the function code.

12.2.2 Debugger Command, *step*

With respect to a function call, the debugger *step* command will step into the function and go to the first line of the function code. It will display the function code. When debugging functions, this is useful to debug the function code.

12.3 Stack Dynamic Local Variables

In a high-level language, non-static local variables declared in a function are stack dynamic local variables by default. Some C++ texts refer to such variables as automatics. This means that the local variables are created by allocating space on the stack and assigning these stack locations to the variables. When the function completes, the space is recovered and reused for other purposes. This requires a small amount of additional run-time overhead, but makes a more efficient overall use of memory. If a function with a large number of local variables is never called, the memory for the local variables is never allocated. This helps reduce the overall memory footprint of the program which generally helps the overall performance of the program.

In contrast, statically declared variables are assigned memory locations for the entire execution of the program. This uses memory even if the associated function is not being executed. However, no additional run-time overhead is required to allocate the space since the space allocation has already been performed (when the program was initially loaded into memory).

12.4 Function Declaration

A function must be written before it can be used. Functions are located in the code segment. The general format is:

```
global <procName>
<procName>:

    ; function body

ret
```

A function may be defined only once. There is no specific order required for how functions are defined. However, functions cannot be nested. A function definition should be started and ended before the next function's definition can be started.

Refer to the sample functions for examples of function declarations and usage.

12.5 Standard Calling Convention

To write assembly programs, a standard process for passing parameters, returning values, and allocating registers between functions is needed. If each function did these operations differently, things would quickly get very confusing and require programmers to attempt to remember for each function how to handle parameters and which registers were used. To address this, a standard process is defined and used which is typically referred to as a *standard calling convention*⁴⁰. There are actually a number of different standard calling conventions. The 64-bit C calling convention, called **System V AMD64 ABI**^{41 42}, is described in the remainder of this document.

This calling convention is also used for C/C++ programs by default. This means that interfacing assembly language code and C/C++ code is easily accomplished since the same calling convention is used.

It must be noted that the standard calling convention presented here applies to Linux based operating systems. The standard calling convention for Microsoft Windows is slightly different and not presented in this text.

40 For more information, refer to: http://en.wikipedia.org/wiki/Calling_convention

41 For more information, refer to:

https://en.wikipedia.org/wiki/X86_calling_conventions#System_V_AMD64_ABI

42 For complete details, refer to: <https://software.intel.com/sites/default/files/article/402129/mpx-linux64-abi.pdf>

12.6 Linkage

The linkage is about getting to and returning from a function call correctly. There are two instructions that handle the linkage, **call** `<funcName>` and **ret** instructions.

The **call** transfers control to the named function, and **ret** returns control back to the calling routine.

- The **call** works by saving the address of where to return to when the function completes (referred to as the *return address*). This is accomplished by placing contents of the **rip** register on the stack. Recall that the **rip** register points to the next instruction to be executed (which is the instruction immediately after the call).
- The **ret** instruction is used in a procedure to return. The **ret** instruction pops the current top of the stack (**rsp**) into the **rip** register. Thus, the appropriate return address is restored.

Since the stack is used to support the linkage, it is important that within the function the stack must not be corrupted. Specifically, any items pushed must be popped. Pushing a value and not popping would result in that value being popped off the stack and placed in the **rip** register. This would cause the processor to attempt to execute code at that location. Most likely the invalid location will cause the process to crash.

The function calling or linkage instruction is summarized as follows:

| Instruction | Explanation |
|---|--|
| call <code><funcName></code> | Calls a function. Push the 64-bit rip register and jump to the <code><funcName></code> . |
| Examples: | call <code>printString</code> |
| ret | Return from a function. Pop the stack into the rip register, effecting a jump to the line after the call. |
| Examples: | ret |

A more complete list of the instructions is located in Appendix B.

12.7 Argument Transmission

Argument transmission refers to sending information (variables, etc.) to a function and obtaining a result as appropriate for the specific function.

The standard terminology for transmitting values to a function is referred to as *call-by-value*. The standard terminology for transmitting addresses to a function is referred to as *call-by-reference*. This should be a familiar topic from a high-level language.

There are various ways to pass arguments to and/or from a function.

- Placing values in register
 - Easiest, but has limitations (i.e., the number of registers).
 - Used for first six integer arguments.
 - Used for system calls.
- Globally defined variables
 - Generally poor practice, potentially confusing, and will not work in many cases.
 - Occasionally useful in limited circumstances.
- Putting values and/or addresses on stack
 - No specific limit to count of arguments that can be passed.
 - Incurs higher run-time overhead.

In general, the calling routine is referred to as the *caller* and the routine being called is referred to as the *callee*.

12.8 Calling Convention

The function *prologue* is the code at the beginning of a function and the function *epilogue* is the code at the end of a function. The operations performed by the prologue and epilogue are generally specified by the standard calling convention and deal with stack, registers, passed arguments (if any), and stack dynamic local variables (if any).

The general idea is that the program state (i.e., contents of specific registers and the stack) are saved, the function executed, and then the state is restored. Of course, the function will often require extensive use of the registers and the stack. The prologue code helps save the state and the epilogue code restores the state.

12.8.1 Parameter Passing

As noted, a combination of registers and the stack is used to pass parameters to and/or from a function.

The first six integer arguments are passed in registers as follows:

| Argument Number | Argument Size | | | |
|-----------------|---------------|------------|------------|------------|
| | 64-bits | 32-bits | 16-bits | 8-bits |
| 1 | rdi | edi | di | dil |
| 2 | rsi | esi | si | sil |
| 3 | rdx | edx | dx | dI |
| 4 | rcx | ecx | cx | cI |
| 5 | r8 | r8d | r8w | r8b |
| 6 | r9 | r9d | r9w | r9b |

The seventh and any additional arguments are passed on the stack. The standard calling convention requires that, when passing arguments (values or addresses) on the stack, the arguments should be pushed in reverse order. That is “**someFunc (one, two, three, four, five, six, seven, eight, nine)**” would imply a push order of: *nine, eight*, and then *seven*.

For floating-point arguments, the floating-point registers **xmm0** to **xmm7** are used in that order for the first eight float arguments.

Additionally, when the function is completed, the calling routine is responsible for clearing the arguments from the stack. Instead of doing a series of pop instructions, the stack pointer, **rsp**, is adjusted as necessary to clear the arguments off the stack. Since each argument is 8 bytes, the adjustment would be adding [(number of arguments) * 8] to the **rsp**.

For value returning functions, the result is placed in the **A** register based on the size of the value being returned. Specifically, the values are returned as follows:

| Return Value Size | Location |
|-------------------|-----------|
| byte | al |

| Return Value Size | Location |
|-------------------|-------------|
| word | ax |
| double-word | eax |
| quadword | rax |
| floating-point | xmm0 |

The **rax** register may be used in the function as needed as long as the return value is set appropriately before returning.

12.8.2 Register Usage

The standard calling convention specifies the usage of registers when making function calls. Specifically, some registers are expected to be preserved across a function call. That means that if a value is placed in a *preserved register* or *saved register*, and the function must use that register, the original value must be preserved by placing it on the stack, altered as needed, and then restored to its original value before returning to the calling routine. This register preservation is typically performed in the prologue and the restoration is typically performed in the epilogue.

The following table summarizes the register usage.

| Register | Usage |
|------------|--------------------------|
| rax | Return Value |
| rbx | Callee Saved |
| rcx | 4 th Argument |
| rdx | 3 rd Argument |
| rsi | 2 nd Argument |
| rdi | 1 st Argument |
| rbp | Callee Saved |
| rsp | Stack Pointer |
| r8 | 5 th Argument |
| r9 | 6 th Argument |
| r10 | Temporary |

| | |
|------------|--------------|
| r11 | Temporary |
| r12 | Callee Saved |
| r13 | Callee Saved |
| r14 | Callee Saved |
| r15 | Callee Saved |

The temporary registers (**r10** and **r11**) and the argument registers (**rdi**, **rsi**, **rdx**, **rcx**, **r8**, and **r9**) are not preserved across a function call. This means that any of these registers may be used in the function without the need to preserve the original value.

Additionally, none of the floating-point registers are preserved across a function call. Refer to Chapter 18 for more information regarding floating-point operations.

12.8.3 Call Frame

The items on the stack as part of a function call are referred to as a *call frame* (also referred to as an *activation record* or *stack frame*). Based on the standard calling convention, the items on the stack, if any, will be in a specific general format.

The possible items in the call frame include:

- Return address (required).
- Preserved registers (if any).
- Passed arguments (if any).
- Stack dynamic local variables (if any).

Other items may be placed in the call frame such as static links for dynamically scoped languages. Such topics are outside the scope of this text and will not be discussed here.

For some functions, a full call frame may not be required. For example, if the function:

- Is a leaf function (i.e., does not call another function).
- Passes its arguments only in registers (i.e., does not use the stack).
- Does not alter any of the saved registers.
- Does not require stack-based local variables.

This can occur for simpler, smaller leaf functions. However, if any of these conditions is not true, a full call frame is required.

For more non-leaf or more complex functions, a more complete call frame is required.

The standard calling convention does not explicitly require use of the frame pointer register, **rbp**. Compilers are allowed to optimize the call frame and not use the frame pointer. To simplify and clarify accessing stack-based arguments (if any) and stack dynamic local variables, this text will utilize the frame pointer register. This is similar to how many other architectures use a frame pointer register.

As such, if there are any stack-based arguments or any local variables needed within a function, the frame pointer register, **rbp**, should be pushed and then set pointing to itself. As additional pushes and pops are performed (thus changing **rsp**), the **rbp** register will remain unchanged. This allows the **rbp** register to be used as a reference to access arguments passed on the stack (if any) or stack dynamic local variables (if any).

For example, assuming a function call has eight (8) arguments and assuming the function uses **rbx**, **r12**, and **r13** registers (and thus must be pushed), the call frame would be as follows:

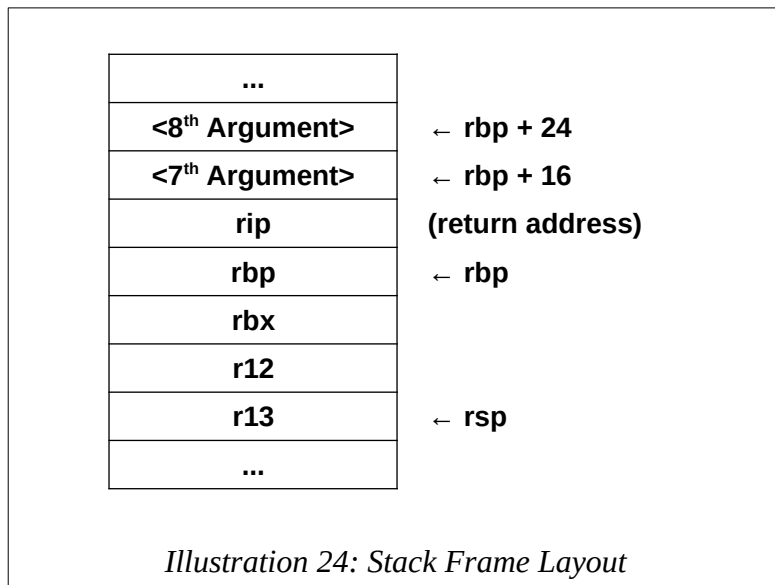

The stack-based arguments are accessed relative to the **rbp**. Each item push is a quadword which uses 8 bytes. For example, [**rbp+16**] is the location of the first passed argument (7th integer argument) and [**rbp+24**] is the location of the second passed argument (8th integer argument).

In addition, the call frame would contain the assigned locations of local variables (if

any). The section on local variables details the specifics regarding allocating and using local variables.

12.8.3.1 Red Zone

In the Linux standard calling convention, the first 128-bytes after the stack pointer, **rsp**, are reserved. For example, extending the previous example, the call frame would be as follows:

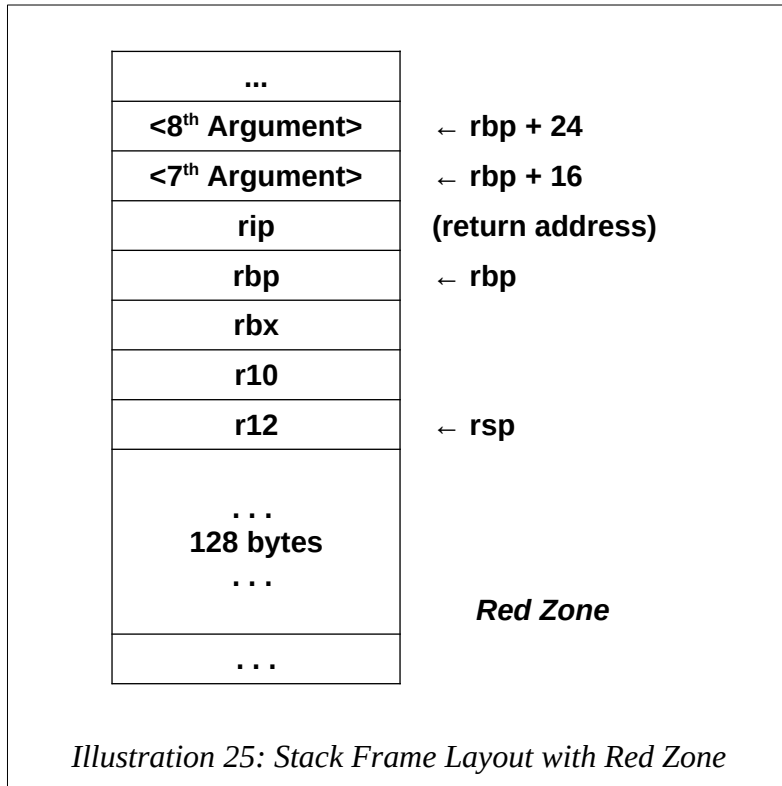

This red zone may be used by the function without any adjustment to the stack pointer. The purpose is to allow compiler optimizations for the allocation of local variables. This does not directly impact programs written directly in assembly language.

12.9 Example, Statistical Function 1 (leaf)

This simple example will demonstrate calling a simple void function to find the sum and average of an array of numbers. The High-Level Language (HLL) call for C/C++ is as

follows:

```
stats1(arr, len, sum, ave);
```

As per the C/C++ convention, the array, **arr**, is call-by-reference and the length, **len**, is call-by-value. The arguments for **sum** and **ave** are both call-by-reference (since there are no values as yet). For this example, the array **arr**, **sum**, and **ave** variables are all signed double-word integers. Of course, in context, the **len** must be unsigned.

12.9.1 Caller

In this case, there are 4 arguments, and all arguments are passed in registers in accordance with the standard calling convention. The assembly language code in the calling routine for the call to the stats function would be as follows:

```
; stats1(arr, len, sum, ave);
mov    rcx, ave                ; 4th arg, addr of ave
mov    rdx, sum                ; 3rd arg, addr of sum
mov    esi, dword [len]        ; 2nd arg, value of len
mov    rdi, arr                ; 1st arg, addr of arr
call   stats1
```

There is no specific required order for setting the argument registers. This example sets them in reverse order in preparation for the next, extended example.

Note, the setting of the **esi** register also sets the upper order double-word to zero, thus ensuring the **rsi** register is set appropriately for this specific usage since length is unsigned.

No return value is provided by this void routine. If the function was a value returning function, the value returned would be in the **A** register (of appropriate size).

12.9.2 Callee

The function being called, the callee, must perform the prologue and epilogue operations (as specified by the standard calling convention) before and after the code to perform the function goal. For this example, the function must perform the summation of values in the array, compute the integer average, return the sum and average values.

The following code implements the **stats1** example.

```
; Simple example function to find and return
; the sum and average of an array.
```

Chapter 12.0 ◀ Functions

```

; HLL call:
; stats1(arr, len, sum, ave);
; -----
; Arguments:
; arr, address - rdi
; len, dword value - esi
; sum, address - rdx
; ave, address - rcx

global stats1
stats1:
    push    r12                ; prologue

    mov     r12, 0              ; counter/index
    mov     rax, 0              ; running sum
sumLoop:
    add     eax, dword [rdi+r12*4] ; sum += arr[i]
    inc     r12
    cmp     r12, rsi
    jl     sumLoop

    mov     dword [rdx], eax     ; return sum

    cdq
    idiv   esi                  ; compute average
    mov     dword [rcx], eax     ; return ave

    pop     r12                ; epilogue
    ret

```

The choice of the **r12** register is arbitrary, however a 'saved register' was selected.

The call frame for this function would be as follows:

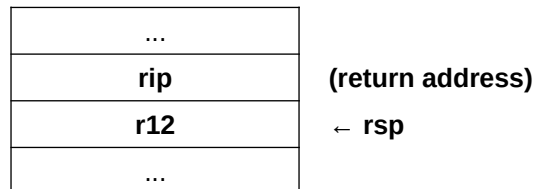

The minimal use of the stack helps reduce the function call run-time overhead.

12.10 Example, Statistical Function2 (non-leaf)

This extended example will demonstrate calling a simple void function to find the minimum, median, maximum, sum and average of an array of numbers. The High-Level Language (HLL) call for C/C++ is as follows:

```
stats2(arr, len, min, med1, med2, max, sum, ave);
```

For this example, it is assumed that the array is sorted in ascending order. Additionally, for this example, the median will be the middle value. For an even length list, there are two middle values, *med1* and *med2*, both of which are returned. For an odd length list, the single middle value is returned in both *med1* and *med2*.

As per the C/C++ convention, the array, *arr*, is call-by-reference and the length, *len*, is call-by-value. The arguments for *min*, *med1*, *med2*, *max*, *sum*, and *ave* are all call-by-reference (since there are no values as yet). For this example, the array *arr*, *min*, *med1*, *med2*, *max*, *sum*, and *ave* variables are all signed double-word integers. Of course, in context, the *len* must be unsigned.

12.10.1 Caller

In this case, there are 8 arguments and only the first six can be passed in registers. The last two arguments are passed on the stack. The assembly language code in the calling routine for the call to the stats function would be as follows:

```
    ; stats2(arr, len, min, med1, med2, max, sum, ave);
    push    ave                ; 8th arg, add of ave
    push    sum                ; 7th arg, add of sum
    mov     r9, max            ; 6th arg, add of max
    mov     r8, med2          ; 5th arg, add of med2
    mov     rcx, med1         ; 4th arg, add of med1
    mov     rdx, min          ; 3rd arg, addr of min
    mov     esi, dword [len]   ; 2nd arg, value of len
    mov     rdi, arr          ; 1st arg, addr of arr
    call   stats2
    add     rsp, 16           ; clear passed arguments
```

The 7th and 8th arguments are passed on the stack and pushed in reverse order in accordance with the standard calling convention. After the function is completed, the arguments are cleared from the stack by adjusting the stack point register (**rsp**). Since two arguments, 8 bytes each, were passed on the stack, 16 is added to the stack pointer.

Note, the setting of the **esi** register also sets the upper order double-word to zero, thus ensuring the **rsi** register is set appropriately for this specific usage since length is unsigned.

No return value is provided by this void routine. If the function was a value returning function, the value returned would be in the **A** register.

12.10.2 Callee

The function being called, the callee, must perform the prologue and epilogue operations (as specified by the standard calling convention). Of course, the function must perform the summation of values in the array, find the minimum, medians, and maximum, compute the average, return all the values.

When call-by-reference arguments are passed on the stack, two steps are required to return the value.

- Get the address from the stack.
- Use that address to return the value.

A common error is to attempt to return a value to a stack-based location in a single step, which will not change the referenced variable. For example, assuming the double-word value to be returned is in the **eax** register and the 7th argument is call-by-reference and where the **eax** value is to be returned, the appropriate code would be as follows:

```
mov    r12, qword [rbp+16]
mov    dword [r12], eax
```

These steps cannot be combined into a single step. The following code

```
mov    dword [rbp+16], eax
```

Would overwrite the address passed on the stack and not change the reference variable.

The following code implements the **stats2** example.

```
; Simple example function to find and return
; the sum and average of an array.
; -----
; HLL call:
; stats2(arr, len, min, med1, med2, max, sum, ave);
; Arguments:
```

```

; arr, address - rdi
; len, dword value - esi
; min, address - rdx
; med1, address - rcx
; med2, address - r8
; max, address - r9
; sum, address - stack (rbp+16)
; ave, address - stack (rbp+24)

global stats2
stats2:
    push    rbp                ; prologue
    mov     rbp, rsp
    push   r12

; -----
; Get min and max.

    mov     eax, dword [rdi]   ; get min
    mov     dword [rdx], eax   ; return min

    mov     r12, rsi           ; get len
    dec     r12                ; set len-1
    mov     eax, dword [rdi+r12*4] ; get max
    mov     dword [r9], eax    ; return max

; -----
; Get medians

    mov     rax, rsi
    mov     rdx, 0
    mov     r12, 2
    div     r12                ; rax = length/2

    cmp     rdx, 0             ; even/odd length?
    je     evenLength

    mov     r12d, dword [rdi+rax*4] ; get arr[len/2]
    mov     dword [rcx], r12d      ; return med1
    mov     dword [r8], r12d      ; return med2
    jmp    medDone

```

Chapter 12.0 ◀ Functions

```
evenLength:
    mov     r12d, dword [rdi+rax*4]      ; get arr[len/2]
    mov     dword [r8], r12d           ; return med2
    dec     rax
    mov     r12d, dword [rdi+rax*4]    ; get arr[len/2-1]
    mov     dword [rcx], r12d         ; return med1
medDone:

; -----
; Find sum

    mov     r12, 0                     ; counter/index
    mov     rax, 0                     ; running sum

sumLoop:
    add     eax, dword [rdi+r12*4]     ; sum += arr[i]
    inc     r12
    cmp     r12, rsi
    jl     sumLoop

    mov     r12, qword [rbp+16]        ; get sum addr
    mov     dword [r12], eax          ; return sum

; -----
; Calculate average.

    cdq
    idiv   rsi                         ; average = sum/len
    mov     r12, qword [rbp+24]        ; get ave addr
    mov     dword [r12], eax          ; return ave

    pop     r12                         ; epilogue
    pop     rbp
    ret
```

The choice of the registers is arbitrary with the bounds of the calling convention.

The call frame for this function would be as follows:

| | |
|----------------------------|-------------------------|
| ... | |
| <8 th Argument> | ← $\text{rbp} + 24$ |
| <7 th Argument> | ← $\text{rbp} + 16$ |
| rip | (return address) |
| rbp | ← rbp |
| rbx | |
| r12 | ← rsp |
| ... | |

The preserved registers, **r12** and **rbp** in this example, are pushed in arbitrary order. However, when popped, they must be popped in the exact reverse order as required to correctly restore their original values.

12.11 Stack-Based Local Variables

If local variables are required, they are allocated on the stack. By adjusting the **rsp** register, additional memory is allocated on the stack for locals. As such, when the function is completed, the memory used for the stack-based local variables is released (and no longer uses memory).

Further expanding the previous example, if we assume all array values are between 0 and 99, and we wish to find the mode (number that occurs the most often), a single double-word variable **count** and a one hundred (100) element local double-word array, **tmpArr[100]** might be used.

As before, the frame register, **rbp**, is pushed on the stack and set pointing to itself. The frame register plus an appropriate offset will allow accessing any arguments passed on the stack. For example, **rbp+16** is the location of the first stack-based argument (7th integer argument).

After the frame register is pushed, an adjustment to the stack pointer register, **rsp**, is made to allocate space for the local variables, a 100-element array in this example. Since the count variable is a one double-word, 4-bytes is needed. The temporary array is 100 double-word elements, 400 bytes is required. Thus, a total of 404 bytes is required. Since the stack is implemented growing downward in memory, the 404 bytes is subtracted from the stack pointer register.

Then any saved registers, **rbx** and **r12** in this example, are pushed on the stack.

Chapter 12.0 ◀ Functions

When leaving the function, the saved registers and then the locals must be cleared from the stack. The preferred method of doing this is to pop the saved registers and then top copy the **rbp** register into the **rsp** register, thus ensuring the **rsp** register points to the correct place on the stack.

```
mov    rsp, rbp
```

This is generally better than adding the offset back to the stack since allocated space may be altered as needed without also requiring adjustments to the epilogue code.

It should be clear that variables allocated in this manner are uninitialized. Should the function require the variables to be initialized, possibly to 0, such initializations must be explicitly performed.

For this example, the call frame would be formatted as follows:

| | |
|----------------|-------------------------|
| ... | |
| <value of len> | ← rbp + 24 |
| <addr of list> | ← rbp + 16 |
| rip | (return address) |
| rbp | ← rbp |
| | tmpArr[99] |
| | tmpArr[98] |
| ... | |
| ... | |
| | tmpArr[1] |
| | ← rbp - 400 = tmpArr[0] |
| | ← rbp - 404 = count |
| rbx | |
| r12 | ← rsp |
| ... | |

The layout and order of the local variables within the allocated 404 bytes is arbitrary.

For example, the updated prologue code for this expanded example would be:

```

push    rbp                ; prologue
mov     rbp, rsp
sub     rsp, 404          ; allocate locals
push    rbx
push    r12

```

The local variables can be accessed relative to the frame pointer register, **rbp**. For example, to initialize the count variables, now allocated to **rbp-404**, the following instruction could be used:

```
mov     dword [rbp-404], 0
```

To access the *tmpArr*, the starting address must be obtained which can be performed with the *lea* instruction. For example,

```
lea     rbx, dword [rbp-400]
```

Which will set the appropriate stack address in the **rbx** register where **rbx** was chosen arbitrarily. The **dword** qualifier in this example is not required, and may be misleading, since addresses are always 64-bits (on a 64-bit architecture). Once set as above, the *tmpArr* starting address in **rbx** is used in the usual manner.

For example, a small incomplete function code fragment demonstrating the accessing of stack-based local variables is as follows:

```

; -----
; Example function

global expFunc
expFunc:
    push    rbp                ; prologue
    mov     rbp, rsp
    sub     rsp, 404          ; allocate locals
    push    rbx
    push    r12

; -----
; Initialize count local variable to 0.

    mov     dword [rbp-404], 0

; -----

```

```

; Increment count variable (for example)...

    inc    dword [rbp-404]           ; count++

; -----
; Loop to initialize tmpArr to all 0's.

    lea   rbx, dword [rbp-400]      ; tmpArr addr
    mov   r12, 0                    ; index
zeroLoop:
    mov   dword [rbx+r12*4], 0      ; tmpArr[index]=0
    inc   r12
    cmp   r12, 100
    jl   zeroLoop

; -----
; Done, restore all and return to calling routine.

    pop   r12                       ; epilogue
    pop   rbx
    mov   rsp, rbp                  ; clear locals
    pop   rbp
    ret

```

Note, this example function focuses only on how stack-based local variables are accessed and does not perform anything useful.

12.12 Summary

This section presents a brief summary of the standard calling convention requirements which are as follows:

Caller Operations:

- The first six integer arguments are passed in registers
 - **rdi, rsi, rdx, rcx, r8, r9**
- The 7th and on arguments are passed on the stack-based
 - Pushes the arguments on the stack in reverse order (right to left, so that the first stack argument specified in the function call is pushed last).
 - Pushed arguments are passed as quadwords.

- The caller executes a **call** instruction to pass control to the function (callee).
- Stack-based arguments are cleared from the stack.
 - **add rsp, <argCount*8>**

Callee Operations:

- Function Prologue
 - If arguments are passed on the stack, the callee must save **rbp** to the stack and move the value of **rsp** into **rbp**. This allows the callee to use **rbp** as a frame pointer to access arguments on the stack in a uniform manner.
 - The callee may then access its parameters relative to **rbp**. The quadword at **[rbp]** holds the previous value of **rbp** as it was pushed; the next quadword, at **[rbp+8]**, holds the return address, pushed by the **call**. The parameters start after that, at **[rbp+16]**.
 - If local variables are needed, the callee decreases **rsp** further to allocate space on the stack for the local variables. The local variables are accessible at negative offsets from **rbp**.
 - The callee, if it wishes to return a value to the caller, should leave the value in **al**, **ax**, **eax**, **rax**, depending on the size of the value being returned.
 - A floating-point result is returned in **xmm0**.
 - If altered, registers **rbx**, **r12**, **r13**, **r14**, **r15** and **rbp** must be saved on the stack.
- Function Execution
 - The function code is executed.
- Function Epilogue
 - Restores any pushed registers.
 - If local variables were used, the callee restores **rsp** from **rbp** to clear the stack-based local variables.
 - The callee restores (i.e., pops) the previous value of **rbp**.
 - The call returns via **ret** instruction (return).

Refer to the sample functions to see specific examples of the calling convention.

12.13 Exercises

Below are some quiz questions and suggested projects based on this chapter.

12.13.1 Quiz Questions

Below are some quiz questions based on this chapter.

- 1) What are the two main actions of a function call?
- 2) What are the two instructions implement *linkage*?
- 3) When arguments are passed using *values*, it is referred to as?
- 4) When arguments are passed using *addresses*, it is referred to as?
- 5) If a function is called fifteen (15) times, how many times is the code placed in memory by the assembler?
- 6) What happens during the execution of a **call** instruction (two things)?
- 7) According to the standard calling convention, as discussed in class, what is the purpose of the initial pushes and final pop's within most procedures?
- 8) If there are six (6) 64-bit integer arguments passed to a function, where specifically should each of the arguments be passed?
- 9) If there are six (6) 32-bit integer arguments passed to a function, where specifically should each of the arguments be passed?
- 10) What does it mean when a register is designated as temporary?
- 11) Name two temporary registers?
- 12) What is the name for the set of items placed on the stack as part of a function call?
- 13) What does it mean when a function is referred to as a *leaf function*?
- 14) What is the purpose of the **add rsp, <immediate>** after the call statement?
- 15) If **three** arguments are passed on the stack, what is the value for the **<immediate>**?
- 16) If there are seven (7) arguments passed to a function, and the function itself pushes the **rbp**, **rbx**, and **r12** registers (in that order), what is the correct offset of the stack-based argument when using the standard calling convention?

- 17) What, if any, is the limiting factor for how many times a function can be called?
- 18) If a function must return a result for the variable *sum*, how should the *sum* variable be passed (call-by-reference or call-by-value)?
- 19) If there are eight (8) arguments passed to a function, and the function itself pushes the **rbp**, **rbx**, and **r12** registers (in that order), what are the correct offsets for each of the two stack-based arguments (7th and 8th) when using the standard calling convention?
- 20) What is the advantage of using stack dynamic local variables (as opposed to using all global variables)?

12.13.2 Suggested Projects

Below are some suggested projects based on this chapter.

- 1) Create a main and implement the *stats1* example function. Use the debugger to execute the program and display the final results. Create a debugger input file to show the results.
- 2) Create a main and implement the *stats2* example function. Use the debugger to execute the program and display the final results. Create a debugger input file to show the results.
- 3) Create a main program and a function that will sort a list of numbers in ascending order. Use the following selection⁴³ sort algorithm:

```

begin
  for i = 0 to len-1
    small = arr(i)
    index = i
    for j = i to len-1
      if ( arr(j) < small ) then
        small = arr(j)
        index = j
      end_if
    end_for
    arr(index) = arr(i)
    arr(i) = small
  end_for
end_begin

```

⁴³ For more information, refer to: http://en.wikipedia.org/wiki/Selection_sort

The main should call the function on at least three different data sets. Use the debugger to execute the program and display the final results. Create a debugger input file to show the results.

- 4) Update the program from the previous question to add a stats function that finds the minimum, median, maximum, sum, and average for the sorted list. The stats function should be called after the sort function to make the minimum and maximum easier to find. Use the debugger to execute the program and display the final results. Create a debugger input file to show the results.
- 5) Update the program from the previous question to add an integer square root function and a standard deviation function. To estimate the square root of a number, use the following algorithm:

$$iSqrt_{est} = iNumber$$

$$iSqrt_{est} = \frac{\left(\frac{iNumber}{iSqrt_{est}}\right) + iSqrt_{est}}{2} \quad \text{iterate 50 times}$$

The formula for standard deviation is as follows:

$$iStandardDeviation = \sqrt{\frac{\sum_{i=0}^{length-1} (list[i] - average)^2}{length}}$$

Note, perform the summation and division using integer values. Use the debugger to execute the program and display the final results. Create a debugger input file to show the results.

- 6) Convert the integer to ASCII macro from the previous chapter into a void function. The function should convert a signed integer into a right-justified string of a given length. This will require including any leading blanks, a sign (“+” or “-”), the digits, and the NULL. The function should accept the value for the integer and the address of where to place the NULL terminated string, and the value of the maximum string length - in that order. Develop a main program to call the function on a series of different integers. The main should include the appropriate data declarations. Use the debugger to execute the program and display the final results. Create a debugger input file to show the results.

- 7) Create a function to convert an ASCII string representing a number into an integer. The function should read the string and perform appropriate error checking. If there is an error, the function should return FALSE (a defined constant set to 0). If the string is valid, the function should convert the string into an integer. If the conversion is successful, the function should return TRUE (a defined constant set to 1). Develop a main program to call the function on a series of different integers. The main should include the appropriate data declarations and applicable the constants. Use the debugger to execute the program and display the final results. Create a debugger input file to show the results.

Linux is basically a simple operating system, but you have to be a genius to understand the simplicity.

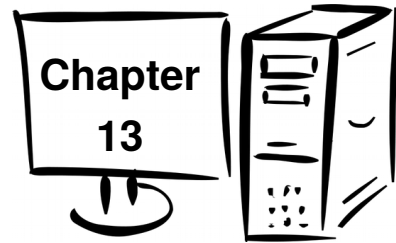

13.0 System Services

There are many operations that an application program must use the operating system to perform. Such operations include console output, keyboard input, file services (open, read, write, close, etc.), obtaining the time or date, requesting memory allocation, and many others.

Accessing system services is how the application requests that the operating system perform some specific operation (on behalf of the process). More specifically, the *system call* is the interface between an executing process and the operating system.

This section provides an explanation of how to use some basic system service calls. More information on additional system service calls is located in Appendix C, System Service Calls.

13.1 Calling System Services

A system service call is logically similar to calling a function, where the function code is located within the operating system. The function may require privileges to operate which is why control must be transferred to the operating system.

When calling system services, arguments are placed in the standard argument registers. System services do not typically use stack-based arguments. This limits the arguments of a system services to six (6), which does not present a significant limitation.

To call a system service, the first step is to determine which system service is desired. There are many system services (see Appendix C). The general process is that the system service call code is placed in the **rax** register. The call code is a number that has been assigned for the specific system service being requested. These are assigned as part of the operating system and cannot be changed by application programs. To simplify the process, this text will define a very small subset of system service call codes to a set of constants. For this text, and the associated examples, the subset of

system call code constants are defined and shown in the source file to help provide complete clarity for new assembly language programmers. For more experienced programmers, typically developing larger or more complex programs, a complete list of constants is in a file and included into the source file.

If any are needed, the arguments for system services are placed in the **rdi**, **rsi**, **rdx**, **r10**, **r8**, and **r9** registers (in that order). The following table shows the argument locations which are consistent with the standard calling convention.

| Register | Usage |
|------------|--------------------------|
| rax | Call code (see table) |
| rdi | 1st argument (if needed) |
| rsi | 2nd argument (if needed) |
| rdx | 3rd argument (if needed) |
| r10 | 4th argument (if needed) |
| r8 | 5th argument (if needed) |
| r9 | 6th argument (if needed) |

This is very similar to the standard calling convention for function calls, however the 4th argument, if needed, uses the **r10** register.

Each system call will use a different number of arguments (from none up to 6). However, the system service call code is always required.

After the call code and any arguments are set, the **syscall** instruction is executed. The **syscall** instruction will pause the current process and transfer control to the operating system which will attempt to perform the service specified in the **rax** register. When the system service returns, the process will be resumed.

13.2 Newline Character

As a refresher, in the context of output, a newline means move the cursor to the start of the next line. The many languages, including C, it is often noted as “\n” as part of a string. C++ uses **endl** in the context of a **cout** statement. For example, “Hello World 1” and “Hello\nWorld 2” would be displayed as follows:

```

Hello World 1
Hello
World 2

```

Nothing is displayed for the newline, but the cursor is moved to the start of the next line as shown.

In Unix/Linux systems, the linefeed, abbreviated LF with an ASCII value of 10 (or 0x0A), is used as the newline character. In Windows systems, the newline is carriage return, abbreviated as CR with an ASCII value 13 (or 0x0D) followed by the LF. The LF is used in the code examples in the text.

The reader may have seen instances where a text file is downloaded from a web page and displayed using Windows Notepad where all the formatting is lost and to look like all the text is one very long line. This is typically due to a Unix/Linux formatted file, which uses only LF's, being displayed with a Windows utility that expects CR/LF pairs and does not display correctly when only LF's are found. Other Windows software, like Notepad++ (open source text editor) will recognize and handle the different newline formats and display correctly.

13.3 Console Output

The system service to output characters to the console is the system write (SYS_write). Like a high-level language characters are written to standard out (STDOUT) which is the console. The STDOUT is the default file descriptor for the console. The file descriptor is already opened and available for use in programs (assembly and high-level languages).

The arguments for the write system service are as follows:

| Register | SYS_write |
|------------|----------------------------------|
| rax | Call code = SYS_write (1) |
| rdi | Output location, STDOUT (1) |
| rsi | Address of characters to output. |
| rdx | Number of characters to output. |

Assuming the following declarations:

```

STDOUT      equ    1                ; standard output
SYS_write   equ    1                ; call code for write

msg        db      "Hello World"
msgLen     dq      11

```

For example to output “Hello World” (it’s traditional) to the console, the system write (SYS_write) would be used. The code would be as follows:

```

mov    rax, SYS_write
mov    rdi, STDOUT
mov    rsi, msg                ; msg address
mov    rdx, qword [msgLen]    ; length value
syscall

```

Refer to the next section for a complete program to display the above message. It should be noted that the operating system does not check if the string is valid.

13.3.1 Example, Console Output

This example is a complete program to output some strings to the console. In this example, one string includes new line and the other does not.

```

; Example program to demonstrate console output.
; This example will send some messages to the screen.

```

```

; *****

```

```

section    .data

```

```

; -----

```

```

; Define standard constants.

```

```

LF            equ    10        ; line feed
NULL         equ    0         ; end of string
TRUE         equ    1
FALSE        equ    0

EXIT_SUCCESS equ    0         ; success code

STDIN        equ    0         ; standard input
STDOUT       equ    1         ; standard output
STDERR       equ    2         ; standard error

SYS_read     equ    0         ; read
SYS_write    equ    1         ; write
SYS_open     equ    2         ; file open
SYS_close    equ    3         ; file close
SYS_fork     equ    57        ; fork

```

```

SYS_exit      equ      60          ; terminate
SYS_creat     equ      85          ; file open/create
SYS_time      equ      201        ; get time

; -----
; Define some strings.

message1      db        "Hello World.", LF, NULL
message2      db        "Enter Answer: ", NULL
newLine       db        LF, NULL

;-----

section       .text
global _start
_start:

; -----
; Display first message.

    mov     rdi, message1
    call   printString

; -----
; Display second message and then newline

    mov     rdi, message2
    call   printString

    mov     rdi, newLine
    call   printString

; -----
; Example program done.

exampleDone:
    mov     rax, SYS_exit
    mov     rdi, EXIT_SUCCESS
    syscall

; *****
; Generic function to display a string to the screen.

```

Chapter 13.0 ◀ System Services

```
; String must be NULL terminated.
; Algorithm:
; Count characters in string (excluding NULL)
; Use syscall to output characters

; Arguments:
; 1) address, string
; Returns:
; nothing

global printString
printString:
    push    rbx

; -----
; Count characters in string.

    mov     rbx, rdi
    mov     rdx, 0
strCountLoop:
    cmp     byte [rbx], NULL
    je      strCountDone
    inc     rdx
    inc     rbx
    jmp     strCountLoop
strCountDone:

    cmp     rdx, 0
    je      prtDone

; -----
; Call OS to output string.

    mov     rax, SYS_write           ; system code for write()
    mov     rsi, rdi                ; address of char's to write
    mov     rdi, STDOUT              ; standard out
                                           ; RDX=count to write, set above
    syscall                          ; system call

; -----
; String printed, return to calling routine.
```



```
prtdone:
    pop    rbx
    ret
```

The output would be as follows:

```
    Hello World.
    Enter Answer:_
```

The newline (LF) was provided as part of the first string (*message1*) thus placing the cursor on the start of the next line. The second message would leave the cursor on the same line which would be appropriate for reading input from the user (which is not part of this example). A final newline is printed since no actual input is obtained in this example.

The additional, unused constants are included for reference.

13.4 Console Input

The system service to read characters from the console is the system read (SYS_read). Like a high-level language, for the console, characters are read from standard input (STDIN). The STDIN is the default file descriptor for reading characters from the keyboard. The file descriptor is already opened and available for use in program (assembly and high-level languages).

Reading characters interactively from the keyboard presents an additional complication. When using the system service to read from the keyboard, much like the write system service, the number of characters to read is required. Of course, we will need to declare an appropriate amount of space to store the characters being read. If we request 10 characters to read and the user types more than 10, the additional characters will be lost, which is not a significant problem. If the user types less than 10 characters, for example 5 characters, all five characters will be read plus the newline (LF) for a total of six characters.

A problem arises if input is redirected from a file. If we request 10 characters, and there are 5 characters on the first line and more on the second line, we will get the six characters from the first line (5 characters plus the newline) and the first four characters from the next line for the total of 10. This is undesirable.

To address this, for interactively reading input, we will read one character at a time until a LF (the Enter key) is read. Each character will be read and then stored, one at a time, in an appropriately sized array.

The arguments for the read system service are as follows:

| Register | SYS_read |
|------------|--|
| rax | Call code = SYS_read (0) |
| rdi | Input location, STDIN (0) |
| rsi | Address of where to store characters read. |
| rdx | Number of characters to read. |

Assuming the following declarations:

```

STDIN    equ    0                ; standard input
SYS_read equ    0                ; call code for read

inChar   db     0

```

For example to read a single character from the keyboard, the system read (SYS_read) would be used. The code would be as follows:

```

mov     rax, SYS_read
mov     rdi, STDIN
mov     rsi, inChar           ; msg address
mov     rdx, 1               ; read count
syscall

```

Refer to the next section for a complete program to read characters from the keyboard.

13.4.1 Example, Console Input

The example is a complete program to read a line of 50 characters from the keyboard. Since space for the newline (LF) along with a final NULL termination is included, an input array allowing 52 bytes would be required.

This example will read up to 50 characters from the user and then echo the input back to the console to verify that the input was read correctly.

```

; Example program to demonstrate console output.
; This example will send some messages to the screen.
; *****

```

```

section    .data

```

```

; -----
; Define standard constants.

LF          equ    10          ; line feed
NULL        equ    0          ; end of string

TRUE        equ    1
FALSE       equ    0

EXIT_SUCCESS equ    0          ; success code

STDIN       equ    0          ; standard input
STDOUT      equ    1          ; standard output
STDERR      equ    2          ; standard error

SYS_read    equ    0          ; read
SYS_write   equ    1          ; write
SYS_open    equ    2          ; file open
SYS_close   equ    3          ; file close
SYS_fork    equ    57         ; fork
SYS_exit    equ    60         ; terminate
SYS_creat   equ    85         ; file open/create
SYS_time    equ    201        ; get time

; -----
; Define some strings.

STRLEN      equ    50

pmpt        db      "Enter Text: ", NULL
newLine     db      LF, NULL

section     .bss
chr         resb    1
inLine     resb    STRLEN+2          ; total of 52

;-----
section     .text
global     _start
_start:

```

```

; -----
; Display prompt.

    mov    rdi, pmpt
    call  printString

; -----
; Read characters from user (one at a time)

    mov    rbx, inLine          ; inLine addr
    mov    r12, 0              ; char count
readCharacters:
    mov    rax, SYS_read       ; system code for read
    mov    rdi, STDIN          ; standard in
    lea   rsi, byte [chr]     ; address of chr
    mov    rdx, 1              ; count (how many to read)
    syscall                    ; do syscall

    mov    al, byte [chr]     ; get character just read
    cmp    al, LF              ; if linefeed, input done
    je     readDone

    inc    r12                 ; count++
    cmp    r12, STRLEN        ; if # chars ≥ STRLEN
    jae   readCharacters     ; stop placing in buffer

    mov    byte [rbx], al     ; inLine[i] = chr
    inc    rbx                 ; update tmpStr addr

    jmp   readCharacters
readDone:
    mov    byte [rbx], NULL   ; add NULL termination

; -----
; Output the line to verify successful read

    mov    rdi, inLine
    call  printString

; -----
; Example done.

```

```

exampleDone:
    mov     rax, SYS_exit
    mov     rdi, EXIT_SUCCESS
    syscall

; *****
; Generic procedure to display a string to the screen.
; String must be NULL terminated.
; Algorithm:
;   Count characters in string (excluding NULL)
;   Use syscall to output characters

; Arguments:
;   1) address, string
; Returns:
;   nothing

global printString
printString:
    push   rbx

; -----
; Count characters in string.

    mov     rbx, rdi
    mov     rdx, 0

strCountLoop:
    cmp     byte [rbx], NULL
    je     strCountDone
    inc     rdx
    inc     rbx
    jmp    strCountLoop
strCountDone:

    cmp     rdx, 0
    je     prtDone

; -----
; Call OS to output string.

```

```

    mov    rax, SYS_write    ; system code for write()
    mov    rsi, rdi         ; address of char's to write
    mov    rdi, STDOUT      ; standard out
                                ; RDX=count to write, set above
    syscall                 ; system call

; -----
; String printed, return to calling routine.

prtDone:
    pop    rbx
    ret

```

If we were to completely stop reading at 50 (STRLEN) characters and the user enters more characters, the characters might cause input errors for successive read operations. To address any extra characters the user might enter, the extra characters are read from the keyboard but not placed in the input buffer (*inLine* above). This ensures that the extra input is removed from the input stream and but does not overrun the array.

The additional, unused constants are included for reference.

13.5 File Open Operations

In order to perform file operations such as read and write, the file must first be opened. There are two file open operations, open and open/create. Each of the two open operations are explained in the following sections.

After the file is opened, in order to perform file read or write operations the operating system needs detailed information about the file, including the complete status and current read/write location. This is necessary to ensure that read or write operations pick up where they left off (from last time).

If the file open operation fails, an error code will be returned. If the file open operation succeeds, a file descriptor is returned. This applies to both high-level languages and assembly code.

The file descriptor is used by the operating system to access the complete information about the file. The complete set of information about an open file is stored in an operating system data structure named File Control Block (FCB). In essence, the file descriptor is used by the operating system to reference the correct FCB. It is the programmer's responsibility to ensure that the file descriptor is stored and use correctly.

13.5.1 File Open

The file open requires that the file exist in order to be opened. If the file does not exist, it is an error.

The file open operation also requires the parameter flag to specify the access mode. The access mode must include one of the following:

- Read-Only Access → `O_RDONLY`
- Write-Only Access → `O_WRONLY`
- Read/Write Access → `O_RDWR`

One of these access modes must be used. Additional access modes may be used by OR'ing with one of these. This might include modes such as append mode (which is not addressed in this text). Refer to Appendix C, System Services for additional information regarding the file access modes.

The arguments for the file open system service are as follows:

| Register | SYS_open |
|------------|---|
| rax | Call code = SYS_open (2) |
| rdi | Address of NULL terminated file name string |
| rsi | File access mode flag |

Assuming the following declarations:

```

SYS_open      equ      2           ; file open

O_RDONLY     equ      000000q     ; read only
O_WRONLY     equ      000001q     ; write only
O_RDWR      equ      000002q     ; read and write

```

After the system call, the **rax** register will contain the return value. If the file open operation fails, **rax** will contain a negative value (i.e., < 0). The specific negative value provides an indication of the type of error encountered. Refer to Appendix C, System Services for additional information on error codes. Typical errors might include invalid file descriptor, file not found, or file permissions error.

If the file open operation succeeds, **rax** contains the file descriptor. The file descriptor will be required for further file operations and should be saved.

Refer to the section on Example File Read for a complete example that opens a file.

13.5.2 File Open/Create

A file open/create operation will create a file. If the file does not exist, a new file will be created. If the file already exists, it will be erased and a new file created. Thus, the previous contents of the file will be lost.

A file access mode must be specified. Since the file is being created, the access mode must include the file permissions that will be set when the file is created. This would include specifying read, write, and/or execute permissions for the *user*, *group*, or *world* as is typical for Linux file permissions. The only permissions addressed in this example are for the user or owner of the file. As such, other users (i.e., using other accounts) will not be able to access the file our program creates. Refer to Appendix C, System Services for additional information regarding the file access modes.

The arguments for the file open/create system service are as follows:

| Register | SYS_creat |
|------------|---|
| rax | Call code = SYS_creat (85) |
| rdi | Address of NULL terminated file name string |
| rsi | File access mode flag |

Assuming the following declarations:

```

SYS_creat    equ    85           ; file open

O_CREAT     equ    0x40
O_TRUNC     equ    0x200
O_APPEND    equ    0x400

S_IRUSR     equ    00400q      ; owner, read permission
S_IWUSR     equ    00200q      ; owner, write permission
S_IXUSR     equ    00100q      ; owner, execute permission

```

The file status flags “S_IRUSR | S_IWUSR” would allow simultaneous read and write, which is typical. The “|” is a logical OR operation, thus combining the selections.

If the file open/create operation does not succeed, a negative value is returned in the **rax** register. If file open/create operation succeeds, a file descriptor is returned. The file

descriptor is used for all subsequent file operations.

Refer to the section on Example File Write for a complete example file open/create.

13.6 File Read

A file must be opened with the appropriate file access flags before it can be read.

The arguments for the file read system service are as follows:

| Register | SYS_read |
|------------|---|
| rax | Call code = SYS_read (0) |
| rdi | File descriptor (of open file) |
| rsi | Address of where to place characters read |
| rdx | Count of characters to read |

Assuming the following declarations:

```
SYS_read    equ    0                ; file read
```

If the file read operation does not succeed, a negative value is returned in the **rax** register. If the file read operation succeeds, the number of characters actually read is returned.

Refer to the next section on example file read for a complete file read example.

13.7 File Write

The arguments for the file write system service are as follows:

| Register | SYS_write |
|------------|---|
| rax | Call code = SYS_write (1) |
| rdi | File descriptor (of open file) |
| rsi | Address of where to place characters to write |
| rdx | Count of characters to write |

Assuming the following declarations:

```
SYS_write    equ    1                ; file write
```

If the file write operation does not succeed, a negative value is returned in the **rax** register. If the file write operation does succeed, the number of characters actually written is returned.

Refer to the section on Example File Read for a complete file write example.

13.8 File Operations Examples

This section contains some simple example programs to demonstrate very basic file I/O operations. The more complex issues regarding file I/O buffering are addressed in a subsequent chapter.

13.8.1 Example, File Write

This example program writes a short message to a file. The file created contains a simple message, a URL in this example. The file name and message to be written to the file are hard-coded. This helps simplify the example, but is not realistic.

Since the open/create service is used, the file will be created (even if an old version must be overwritten).

```

; Example program to demonstrate file I/O. This example
; will open/create a file, write some information to the
; file, and close the file. Note, the file name and
; write message are hard-coded for the example.
;-----

section    .data

; -----
; Define standard constants.

LF          equ    10          ; line feed
NULL        equ    0          ; end of string
TRUE        equ    1
FALSE       equ    0
EXIT_SUCCESS equ    0          ; success code
STDIN       equ    0          ; standard input
STDOUT      equ    1          ; standard output
STDERR      equ    2          ; standard error

SYS_read    equ    0          ; read

```

```

SYS_write      equ      1          ; write
SYS_open       equ      2          ; file open
SYS_close      equ      3          ; file close
SYS_fork       equ      57         ; fork
SYS_exit       equ      60         ; terminate
SYS_creat      equ      85         ; file open/create
SYS_time      equ      201        ; get time

O_CREAT       equ      0x40
O_TRUNC       equ      0x200
O_APPEND      equ      0x400

O_RDONLY      equ      000000q    ; read only
O_WRONLY      equ      000001q    ; write only
O_RDWR       equ      000002q    ; read and write

S_IRUSR       equ      00400q
S_IWUSR       equ      00200q
S_IXUSR       equ      00100q

; -----
; Variables for main.

newLine       db        LF, NULL
header        db        LF, "File Write Example."
              db        LF, LF, NULL
fileName      db        "url.txt", NULL
url           db        "http://www.google.com"
              db        LF, NULL
len           dq        $-url-1

writeDone     db        "Write Completed.", LF, NULL
fileDescrip   dq        0
errMsgOpen   db        "Error opening file.", LF, NULL
errMsgWrite   db        "Error writing to file.", LF, NULL

;-----

section      .text
global      _start
_start:

```

```

; -----
; Display header line...

    mov    rdi, header
    call  printString

; -----
; Attempt to open file.
; Use system service for file open

; System Service - Open/Create
; rax = SYS_creat (file open/create)
; rdi = address of file name string
; rsi = attributes (i.e., read only, etc.)

; Returns:
; if error -> eax < 0
; if success -> eax = file descriptor number

; The file descriptor points to the File Control
; Block (FCB). The FCB is maintained by the OS.
; The file descriptor is used for all subsequent
; file operations (read, write, close).

openInputFile:
    mov    rax, SYS_creat           ; file open/create
    mov    rdi, fileName           ; file name string
    mov    rsi, S_IRUSR | S_IWUSR  ; allow read/write
    syscall                         ; call the kernel

    cmp    rax, 0                  ; check for success
    jl    errorOnOpen

    mov    qword [fileDescrip], rax ; save descriptor

; -----
; Write to file.
; In this example, the characters to write are in a
; predefined string containing a URL.

; System Service - write
; rax = SYS_write
; rdi = file descriptor

```

```

; rsi = address of characters to write
; rdx = count of characters to write
; Returns:
; if error -> rax < 0
; if success -> rax = count of characters actually read

    mov     rax, SYS_write
    mov     rdi, qword [fileDescriptor]
    mov     rsi, url
    mov     rdx, qword [len]
    syscall

    cmp     rax, 0
    jl     errorOnWrite

    mov     rdi, writeDone
    call    printString

    jmp    exampleDone

; -----
; Close the file.
; System Service - close
; rax = SYS_close
; rdi = file descriptor

    mov     rax, SYS_close
    mov     rdi, qword [fileDescriptor]
    syscall

    jmp    exampleDone

; -----
; Error on open.
; note, rax contains an error code which is not used
;     for this example.

errorOnOpen:
    mov     rdi, errMsgOpen
    call    printString

    jmp    exampleDone

```

```

; -----
; Error on write.
; note, rax contains an error code which is not used
;     for this example.

errorOnWrite:
    mov    rdi, errMsgWrite
    call  printString

    jmp  exampleDone

; -----
; Example program done.

exampleDone:
    mov    rax, SYS_exit
    mov    rdi, EXIT_SUCCESS
    syscall

; *****
; Generic procedure to display a string to the screen.
; String must be NULL terminated.
; Algorithm:
; Count characters in string (excluding NULL)
; Use syscall to output characters

; Arguments:
;     1) address, string
; Returns:
;     nothing

global printString
printString:
    push  rbp
    mov   rbp, rsp
    push  rbx

; -----
; Count characters in string.

    mov   rbx, rdi

```

```

    mov    rdx, 0
strCountLoop:
    cmp    byte [rbx], NULL
    je     strCountDone
    inc    rdx
    inc    rbx
    jmp    strCountLoop
strCountDone:
    cmp    rdx, 0
    je     prtDone

; -----
; Call OS to output string.

    mov    eax, SYS_write           ; code for write()
    mov    rsi, rdi                 ; addr of characters
    mov    rdi, STDOUT             ; file descriptor
                                           ; count set above
    syscall                         ; system call

; -----
; String printed, return to calling routine.

prtDone:
    pop    rbx
    pop    rbp
    ret

; *****

```

This example creates the file which is read by the next example.

13.8.2 Example, File Read

This example will read a file. The file to be read contains a simple message, the URL from the previous example. The file name is hard-coded which helps simplify the example, but is not realistic. The file name used matches the previous file write example. If this example program is executed prior to the write example program being executed, it will generate an error since the file will not be found. After the file write example program is executed, this file read example program will read the file and display the contents.

```

; Example program to demonstrate file I/O.

; This example will open/create a file, write some
; information to the file, and close the file.

; Note, the file name is hard-coded for this example.

; This example program will open a file, read the
; contents, and write the contents to the screen.
; This routine also provides some very simple examples
; regarding handling various errors on system services.

; -----

section    .data

; -----
; Define standard constants.

LF          equ    10          ; line feed
NULL        equ    0          ; end of string

TRUE        equ    1
FALSE       equ    0
EXIT_SUCCESS equ    0          ; success code
STDIN       equ    0          ; standard input
STDOUT      equ    1          ; standard output
STDERR      equ    2          ; standard error

SYS_read    equ    0          ; read
SYS_write   equ    1          ; write
SYS_open    equ    2          ; file open
SYS_close   equ    3          ; file clos
SYS_fork    equ    57         ; fork
SYS_exit    equ    60         ; terminate
SYS_creat   equ    85         ; file open/create
SYS_time    equ    201        ; get time

O_CREAT     equ    0x40
O_TRUNC     equ    0x200
O_APPEND    equ    0x400

```



```

O_RDONLY      equ      000000q    ; read only
O_WRONLY      equ      000001q    ; write only
O_RDWR       equ      000002q    ; read and write

S_IRUSR       equ      00400q
S_IWUSR       equ      00200q
S_IXUSR       equ      00100q

; -----
; Variables/constants for main.

BUFF_SIZE     equ 255

newLine       db      LF, NULL
header        db      LF, "File Read Example."
              db      LF, LF, NULL

fileName      db      "url.txt", NULL
fileDescrip   dq      0

errMsgOpen    db      "Error opening the file.", LF, NULL
errMsgRead    db      "Error reading from the file.", LF, NULL

; -----

section       .bss
readBuffer   resb   BUFF_SIZE

; -----

section       .text
global _start
_start:

; -----
; Display header line...

    mov     rdi, header
    call   printString

; -----

```

```

; Attempt to open file - Use system service for file open

; System Service - Open
;   rax = SYS_open
;   rdi = address of file name string
;   rsi = attributes (i.e., read only, etc.)
; Returns:
;   if error -> eax < 0
;   if success -> eax = file descriptor number

; The file descriptor points to the File Control
; Block (FCB). The FCB is maintained by the OS.
; The file descriptor is used for all subsequent file
; operations (read, write, close).

openInputFile:
    mov     rax, SYS_open           ; file open
    mov     rdi, fileName          ; file name string
    mov     rsi, O_RDONLY          ; read only access
    syscall                               ; call the kernel

    cmp     rax, 0                 ; check for success
    jl     errorOnOpen

    mov     qword [fileDescrip], rax ; save descriptor

; -----
; Read from file.
; For this example, we know that the file has only 1 line.

; System Service - Read
;   rax = SYS_read
;   rdi = file descriptor
;   rsi = address of where to place data
;   rdx = count of characters to read
; Returns:
;   if error -> rax < 0
;   if success -> rax = count of characters actually read

    mov     rax, SYS_read
    mov     rdi, qword [fileDescrip]
    mov     rsi, readBuffer

```

```

    mov    rdx, BUFF_SIZE
    syscall

    cmp    rax, 0
    jl     errorOnRead

; -----
; Print the buffer.
; add the NULL for the print string

    mov    rsi, readBuffer
    mov    byte [rsi+rax], NULL

    mov    rdi, readBuffer
    call   printString

    printNewLine

; -----
; Close the file.
; System Service - close
;     rax = SYS_close
;     rdi = file descriptor

    mov    rax, SYS_close
    mov    rdi, qword [fileDescriptor]
    syscall

    jmp    exampleDone

; -----
; Error on open.
; note, eax contains an error code which is not used
;     for this example.

errorOnOpen:
    mov    rdi, errMsgOpen
    call   printString

    jmp    exampleDone

; -----

```

Chapter 13.0 ◀ System Services

```
; Error on read.
; note, eax contains an error code which is not used
;     for this example.

errorOnRead:
    mov     rdi, errMsgRead
    call   printString

    jmp     exampleDone

; -----
; Example program done.

exampleDone:
    mov     rax, SYS_exit
    mov     rdi, EXIT_SUCCESS
    syscall

; *****
; Generic procedure to display a string to the screen.
; String must be NULL terminated.
; Algorithm:
; Count characters in string (excluding NULL)
; Use syscall to output characters

; Arguments:
;     1) address, string
; Returns:
;     nothing

global printString
printString:
    push   rbp
    mov    rbp, rsp
    push  rbx

; -----
; Count characters in string.

    mov    rbx, rdi
    mov    rdx, 0
strCountLoop:
```

```

    cmp    byte [rbx], NULL
    je     strCountDone
    inc    rdx
    inc    rbx
    jmp    strCountLoop
strCountDone:

    cmp    rdx, 0
    je     prtDone

; -----
; Call OS to output string.

    mov    eax, SYS_write          ; code for write()
    mov    rsi, rdi                ; addr of characters
    mov    rdi, STDOUT             ; file descriptor
                                        ; count set above
    syscall                        ; system call

; -----
; String printed, return to calling routine.

prtDone:
    pop    rbx
    pop    rbp
    ret

```

The `printString()` function is the exact same in both examples and is only repeated to allow each program to be assembled and executed independently.

13.9 Exercises

Below are some quiz questions and suggested projects based on this chapter.

13.9.1 Quiz Questions

Below are some quiz questions based on this chapter.

- 1) When using a system service, where is the *call code* placed?
- 2) Where is the code located when the **syscall** instruction is executed?
- 3) What is the call code and required arguments for a system service call to perform

console output?

- 4) Why was only one character read for interactive keyboard input?
- 5) What is returned for a successful file open system service call?
- 6) What is returned for an unsuccessful file open system service call?
- 7) If a system service call requires six (6) arguments, where specifically should they be passed?

13.9.2 Suggested Projects

Below are some suggested projects based on this chapter.

- 1) Implement the *printString()* example void function and a simple main to test of a series of strings. Use the debugger to execute the program and display the final results. Execute the program without the debugger and verify the appropriate output is displayed to the console.
- 2) Convert the example program to read input from keyboard into a *readString()* function. The function should accept arguments for the string address and maximum string length (in that order). The maximum length should include space for the NULL (an extra byte), which means the function must not allow more than the maximum minus one characters to be stored in the string. If additional characters are entered by the user, they should be cleared from the input stream, but not stored. The function should not include the newline in the returned string. The function should return the number of characters in the string not including the NULL. The *printString()* function from the previous problem should be used unchanged. When done, create an appropriate main to test the function. Use the debugger as necessary to debug the program. When working correctly, execute the program from the command line which will display the final results to the console.
- 3) Based on the file write example, create a value returning *fileWrite()* function to write a password to a file. The function should arguments for the address of the file name and the address of the NULL terminated password string. The file should be created, opened, the password string written to the file, and the file closed. The function should return SUCCESS if the operations worked correctly or NOSUCCESS if there is a problem. Problems might include not being able to create the file or not being able to write to the file. Create an appropriate main to test the function. Use the debugger as necessary to debug the program. When working correctly, execute the program from the command line which will

display the final results to the console.

- 4) Based on the file read example, create a value returning *fileRead()* function to read a password from a file. The function should accept arguments for the address of file name, the address of where to store the password string, the maximum length of the password string, and the address of where to store the password length. The function should open the file, read a string representing a password, close the file, and return the number of characters in the password. The maximum length should include space for the NULL, which means the function read must not store more than the maximum minus one characters in the string. The function should return SUCCESS if the operations worked correctly or NOSUCCESS if there is a problem. Problems might include the file not existing or other read errors. Create an appropriate main to test the function. Use the debugger as necessary to debug the program. When working correctly, execute the program from the command line which will display the final results to the console.

My new computer is so fast, it executes an infinite loop in 6 seconds.

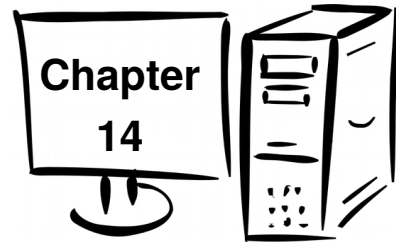

14.0 Multiple Source Files

As a program grows in size and complexity, it is common that different parts of the program are stored in different source files. This allows a programmer to ensure the source files do not become unreasonable large and would also allow multiple programmers to more easily work on different parts of the program.

The function calls, even those written by different programmers, will work together correctly due to the standard calling convention as outlined in Chapter 12, Functions. This is even true when interfacing with a high-level language.

This chapter will present a simple assembly language example to demonstrate how to create and use source code in multiple files. In addition, an example of how to interface with a C/C++ source file is provided.

14.1 Extern Statement

If a function is called from a source file and the function code is not located in the current source file, the assembler will generate an error. The same applies to variables accessed that are not located in the current file. In order to inform the assembler that the function code or variables are in another file, the **extern** statement is used. The syntax is as follows:

```
extern <symbolName>
```

The symbol name would be the name of the function or a variable that is located in a different source file. In general, using global variables accessed across multiple files is considered poor programming practice and should be used sparingly (if at all). Data is typically passed between functions as arguments for the function call.

The examples in the text focus on using external functions only with no globally declared variables.

14.2 Example, Sum and Average

The following is a simple example of a main that calls an assembly language function, *stats()*, to compute the integer sum and integer average for a list of signed integers. The main and the function are in different source files and are presented as an example of how multiple source files are used. The example itself is really too small to actually require multiple source files.

14.2.1 Assembly Main

The main is as follows:

```

; Simple example to call an external function.

; -----
; Data section

section    .data

; -----
; Define standard constants

LF          equ    10          ; line feed
NULL        equ    0          ; end of string

TRUE        equ    1
FALSE       equ    0

EXIT_SUCCESS equ    0          ; success code

; -----
; Declare the data

lst1        dd    1, -2, 3, -4, 5
            dd    7, 9, 11
len1        dd    8

lst2        dd    2, -3, 4, -5, 6
            dd    -7, 10, 12, 14, 16
len2        dd    10

```

```

section    .bss
sum1      resd    1
ave1      resd    1

sum2      resd    1
ave2      resd    1

; -----

extern stats

section .text
global _start
_start:

; ----
; Call the function
;     HLL Call:  stats(lst, len, &sum, &ave);

    mov     rdi, lst1                ; data set 1
    mov     esi, dword [len1]
    mov     rdx, sum1
    mov     rcx, ave1
    call    stats

    mov     rdi, lst2                ; data set 2
    mov     esi, dword [len2]
    mov     rdx, sum2
    mov     rcx, ave2
    call    stats

; -----
; Example program done

exampleDone:
    mov     rax, SYS_exit
    mov     rdi, EXIT_SUCCESS
    syscall

```

The above main can be assembled with the same assemble command as described in Chapter 5, Tool chain. The **extern** statement will ensure that the assembler does not generate errors.

14.2.2 Function Source

The function, in a different source file is as follows:

```

; Simple example void function.

; *****
; Data declarations
; Note, none needed for this example.
; If needed, they would be declared here as always.

section    .data

; *****

section    .text

; -----
; Function to find integer sum and integer average
; for a passed list of signed integers.

; Call:
; stats(lst, len, &sum, &ave);

; Arguments Passed:
;     1) rdi - address of array
;     2) rsi - length of passed array
;     3) rdx - address of variable for sum
;     4) rcx - address of variable for average

; Returns:
;     sum of integers (via reference)
;     average of integers (via reference)

global stats
stats:
    push    r12

; -----
; Find and return sum.

    mov     r11, 0                ; i=0
    mov     r12d, 0              ; sum=0

```

```

sumLoop:
    mov    eax, dword [rdi+r11*4]    ; get lst[i]
    add    r12d, eax                ; update sum
    inc    r11                      ; i++
    cmp    r11, rsi
    jb     sumLoop

    mov    dword [rdx], r12d        ; return sum

; -----
; Find and return average.

    mov    eax, r12d
    cdq
    idiv   esi

    mov    dword [rcx], eax         ; return average

; -----
; Done, return to calling function.

    pop    r12
    ret

```

The above source file can be assembled with the same assemble command as described in Chapter 5, Tool chain. No **extern** statement is required since no external functions are called.

14.2.3 Assemble and Link

Assuming the main source file is named *main.asm* and the functions source file is named *stats.asm*, the following command will perform the assemble and link.

```

yasm -g dwarf2 -f elf64 main.asm -l main.lst
yasm -g dwarf2 -f elf64 stats.asm -l stats.lst
ld -g -o main main.o stats.o

```

The files names can be changed as desired.

As usual, the debugger is started with the **ddd <executable>** command. It would be appropriate to noted that using the debugger **step** command will step into the

function, including showing the function source code (even if the source is in a different file). The debugger **next** command will execute the entire function and not show the source. If the function is working, the **next** command would be most useful. In order to debug the function, the **step** command would be most useful.

If the “-g” option is omitted, the debugger will not be able to display the source code.

14.3 Interfacing with a High-Level Language

This section provides information on how a high-level language can call an assembly language function and how an assembly language function can call a high-level language function. This chapter presents examples for both.

In brief, the answer of how this is accomplished is through the standard calling convention. As such, no additional or special code is needed when interfacing with a high-level language. The compiler or assembler will need to be informed about the external routines in order to avoid error messages about not being able to find the source code for the non-local routines.

The general process for linking for multiple files was described in Chapter 5, Tool Chain. The process of using multiple source files was described in Chapter 14, Multiple Source Files. It does not matter if the object files are from a high-level language or from an assembly language source.

14.3.1 Example, C++ Main / Assembly Function

When calling any functions that are in a separate source file, the compiler must be informed that the function or functions source code are external to the current source file. This is performed with an **extern** statement in C or C++. Other languages will have a similar syntax. For a high-level language, the **extern** statement will include the function prototype which will allow the compiler to verify the function parameters and associated types.

The following is a simple example using a C++ main with an assembly language function.

```
#include <iostream>
using namespace std;
extern "C" void stats(int[], int, int *, int *);

int main()
{
```

```

int lst[] = {1, -2, 3, -4, 5, 7, 9, 11};
int len = 8;
int sum, ave;

stats(lst, len, &sum, &ave);

cout << "Stats:" << endl;
cout << "  Sum = " << sum << endl;
cout << "  Ave = " << ave << endl;

return 0;
}

```

At this point, the compiler does not know the external function is written in assembly (nor does it matter).

The C compiler is pre-installed on Ubuntu. However, the C++ compiler is not installed by default.

A C version of the same program is also presented for completeness.

```

#include<stdio.h>
extern void stats(int[], int, int *, int *);

int main()
{
    int lst[] = {1, -2, 3, -4, 5, 7, 9, 11};
    int len = 8;
    int sum, ave;

    stats(lst, len, &sum, &ave);

    printf ("Stats:\n");
    printf ("  Sum = %d \n", sum);
    printf ("  Ave = %d \n", ave);

    return 0;
}

```

The `stats()` function referenced here should be used unchanged from the previous example.

14.3.2 Compile, Assemble, and Link

As noted in the Functions Chapter, the C++ compiler should be used. For example, assuming that the C++ main is named *main.cpp*, and the assembly source file is named *stats.asm*, the commands to compile, assemble, link, and execute as follows:

```
g++ -g -Wall -c main.cpp
yasm -g dwarf2 -f elf64 stats.asm -l stats.lst
g++ -g -o main main.o stats.o
```

Note, Ubuntu 18 will require the **no-pie** option on the g++ command as shown:

```
g++ -g -no-pie -o main main.o stats.o
```

The file names can be changed as desired. Upon execution, the output would be as follows:

```
./main
Stats:
  Sum = 30
  Ave = 3
```

If a C main is used, and assuming that the C main is named *main.c*, and the assembly source file is named *stats.asm*, the commands to compile, assemble, link, and execute as follows:

```
gcc -g -Wall -c main.c
yasm -g dwarf2 -f elf64 stats.asm -l stats.lst
gcc -g -o main main.o stats.o
```

Note, Ubuntu 18 will require the **no-pie** option on the gcc command as shown:

```
gcc -g -no-pie -o main main.o stats.o
```

The C compiler, **gcc**, or the C++ compiler, **g++**, is used to perform the linking as it is aware of the appropriate locations for the various C/C++ libraries.

14.4 Exercises

Below are some quiz questions and suggested projects based on this chapter.

14.4.1 Quiz Questions

Below are some quiz questions based on this chapter.

- 1) What is the statement to declare the functions, *func1()* and *func2()*, as external assuming no arguments are needed for either function?
- 2) What is the statement to declare the functions, *func1()* and *func2()*, as external if two integer arguments are used for each function?
- 3) What will happen if an external function is called but is not declared as external?
- 4) If an externally declared function is called but the programmer did not actually write the function, when would the error be flagged, assemble time, link time, or run time?
- 5) If an externally declared function is called but the programmer did not actually write the function, what might the error be?
- 6) If the “-g” option is omitted from the assemble and link commands, would the program be able to execute?

14.4.2 Suggested Projects

Below are some suggested projects based on this chapter.

- 1) Implement the assembly language example program to find the sum and average for a list of signed integers. Ensure that the main and function are in different source files. Use the debugger to execute the program and display the final results.
- 2) Based on the example function *stats()*, split it into two value returning functions, *lstSum()* and *lstAverage()*. As noted in Chapter 12, Functions, value returning functions return their result in the **A** register. Since these are double-words, the result will be returned in **eax**. Ensure that the main and both functions are in two different source files. The two functions can be in the same source file. Use the debugger to execute the program and display the final results.
- 3) Extend the previous exercise to display the sum and average to the console. The *printString()* example function (from multiple previous examples) should be placed in a third source file (which can be used on other exercises). This project will require a function to convert an integer to ASCII (as outlined in Chapter 10). Use the debugger as needed to debug the program. When working, execute the program without the debugger and verify that the correct results are displayed to the console.

- 4) Implement one of the C/C++ example main programs (either one). Additionally, implement the assembly language *stats()* function example. Develop a simple bash script to perform the compile, assemble, and link. The link should be performed with the applicable C/C++ compiler. Use the debugger as needed to debug the program. When working, execute the program without the debugger and verify that the correct results are displayed to the console.

*My new computer is so fast it requires two
HALT instructions to stop it.*

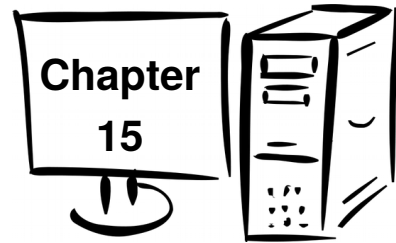

15.0 Stack Buffer Overflow

A stack buffer overflow⁴⁴ can occur when a program overflows a stack-based dynamic variable (as described in Chapter 12.9, Stack-Based Local Variables). For example, if a program allocates and uses a stack-based local array holding 50 elements and more than 50 elements are stored in the array, an overflow occurs. Such overflows are generally bad and typically cause program bugs and possibly even crash the program. The stack will contain other important information such as other variables, persevered registers, frame point, return address, and/or stack-based parameters. If such data is over-written, it will likely cause problems which can be very difficult to debug since the symptom will likely be unrelated to where the problem actually occurs.

If a stack buffer overflow is caused deliberately as part of an attack it is referred to as stack smashing. Due to the standard calling convention, the layout of the stack-based call frame or activation record is fairly predictable. Such a stack buffer overflow can be by a malicious individual to inject executable code into the currently running program to perform some inappropriate actions. Under the right circumstances, such code injection could allow a black-hat⁴⁵ hacker to perform unwanted actions potentially taking over the system.

The process of how a stack buffer overflow occurs and how it can be exploited are provided in this chapter. This is presented in order to allow developers to clearly understand the problem and thus learn how to protect themselves against such vulnerabilities. The reader must be familiar with the details of the standard calling convention as outlined in Chapter 12, Functions.

It should be noted that the stack buffer overflow problem exists in high-level languages. Working in assembly languages makes it easier to more clearly see and understand the details.

44 For more information, refer to: http://en.wikipedia.org/wiki/Stack_buffer_overflow

45 For more information, refer to: http://en.wikipedia.org/wiki/Black_hat

15.1 Understanding a Stack Buffer Overflow

When a program calls a function, the standard calling convention provides the guidance for how the parameters are passed, how the return address is saved, how and which registers must be preserved, and how stack-based local variables are to be allocated.

For example, consider the function call;

```
expFunc(arg1, arg2, arg3);
```

In addition, we will assume that the function, *expFunc()*, reads in a line of text from the user and stores it in a locally declared array. The local variables include the array of 48 bytes and one quadword local variable (8 bytes). This can be accomplished easily in a high-level language or as is done in Chapter 13, System Services, Console Input.

The resulting call frame would be as follows:

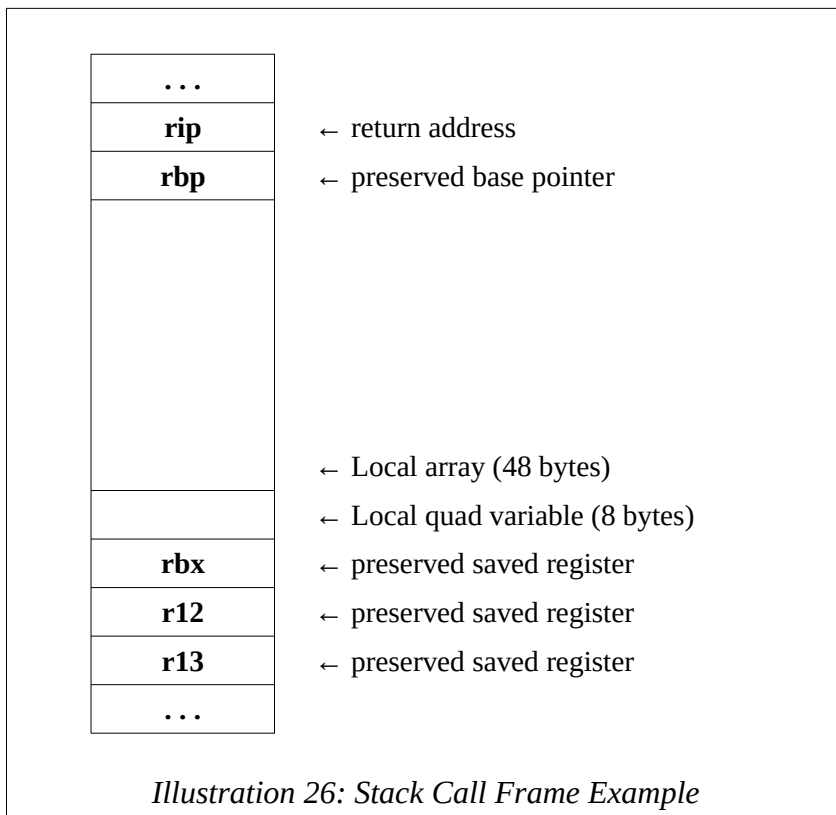

When the function completes, all elements of the call frame are removed. The preserved registers are restored to their original contents, the local variables are removed, and the return address is copied off the stack and placed in the **rip** register which effects a jump back to the original calling routine. As noted in Chapter 12, Functions, this layout supports multiple levels of function calls including recursion.

The example in Chapter 13 that reads characters from the user and entered them into an array explicitly checked the character count to ensure that the count does not exceed the buffer size. It would be easy to forget to perform this important check. Indeed, some C functions such as *strcpy()* do not perform verification of sizes and are thus considered unsafe⁴⁶ or described as an unsafe function.

In this example, overwriting the 48 character buffer will destroy the contents of the stack that contain the original values for the **rbp** register and possibly the **rip** register. If the stack contents of the original value of the **rip** register is altered or corrupted in any way, the function will not be able to return to the calling routine and would attempt to jump to some random location. If the random location is outside the program scope, which is likely, the program will generate a segment fault (i.e., “seg fault” or program crash).

Debugging this type of error can be a significant challenge. The error appears at the very end of the function (on the return). The problem is actually in the body of the function and in fact may be due to code that is not included (as opposed to wrong code that is there).

Testing if a program has this vulnerability would involve typing significantly more characters than expected when prompted. For example, if name is prompted for and 200 characters are entered (possibly by holding down a key), the program crashing would be a sign that such a vulnerability exists. An error message would indicate such a vulnerability does not exist. While straightforward, this type of testing is often not checked thoroughly or even omitted entirely.

15.2 Code to Inject

Before discussing how the stack buffer overflow might be exploited, we will review what code might be injected. The code to be injected could be many things. We will assume the program is being executed in a controlled environment with no console access for the user. The lack of console access would limit what a user could do ideally to only what the program allowed. This might be the case if the program is server-based

46 For more information, refer to:

http://en.wikipedia.org/wiki/C_standard_library#Buffer_overflow_vulnerabilities

interacting with a user through a web or application front-end. The server would be protected from direct user access for obvious security reasons.

As such, one possible attack vector might be to obtain console access to the back-end server (where such access is normally not allowed).

There is a system service that can execute another program. Using this system service, `exec`, we could execute the `sh` program (shell) which is a standard Linux program. This will create and open a shell providing console access. The newly created shell is limited to the privileges of the process that started it. In a good security environment, the process will be granted only the privileges it requires. In a poor security environment, the process may have additional, unnecessary privilege which would make it easier for an unauthorized black-hat hacker to cause problems.

Given the following data declarations:

```

NULL          equ      0
progName      db       "/bin/sh", NULL

```

An example of the `exec` system service would be as follows:

; Example, system service call for `exec`.

```

mov    rax, 59
mov    rdi, progName
syscall

```

A new console will appear. The reader is encouraged to try this code example and see it work.

The list file for this code fragment would be as follows:

```

40 00000000 48C7C03B000000          mov rax, 59
41 00000007 48C7C7[00000000]          mov rdi, progName
42 0000000E 0F05                      syscall

```

Recall that the first column is the line number, the second column is relative address in the code section and the third column is the machine language or the hex representation of the human readable instruction shown in the fourth column. The `[00000000]` represents the relative address of the string in the data section (`progName` in this example). It is zero since it is the first (and only) variable in the data section for this example.

If the machine language shown is entered into memory and executed, a shell or console would be opened. Getting the hex version of the code into memory can only be performed via the keyboard (since there is no direct access to file system). This would be done one character at a time. The 0x48 is the ASCII code for “0”, so “0” could be entered for that byte. However, the 0x0f and many of the other characters are more difficult to enter directly as ASCII.

The command shell will allow entry of hex code in hex. By typing control key and the left shift followed by a lower-case u and then four hex digits, the hex values can be entered one at a time. For example, to enter the 0x05, it would be;

CTRL SHIFT u 0 0 0 5

This can be done for most of the bytes except the 0x00. The 0x00 is a NULL which is a non-printable ASCII characters (used to mark string terminations). As such, the NULL cannot be entered from the keyboard. Additionally, the [00000000] address would not make sense if the code is injected into another program.

To address these issues, we can re-write the example code and eliminate the NULL's and change the address reference. The NULL's can be eliminated by using different instructions. For example, setting **rax** to 59 can be accomplished by xor'ing **rax** with itself and placing the 59 in **al** (having already ensured the upper 56 bits are 0 via the xor). The string can be placed on the stack and the current **rsp** used as the address of the string. The string, “\bin\sh” is 7 bytes and the stack operation will require a push of 8 bytes. Again, the NULL cannot be entered and is not counted. An extra, unnecessary “/” can be added to the string which will not impact the operation providing exactly 8 bytes in the string. Since the architecture is little-endian, in order to ensure that the starting of the string is in low memory, it must be in the least significant byte of the push. This will make the string appear backwards.

The revised program fragment would be as follows:

```

xor    rax, rax           ; clear rax
push   rax              ; place NULLs on stack
mov    rbx, 0x68732f6e69622f2f ; string -> "//bin/sh"
push   rbx              ; put string in memory
mov    al, 59           ; call code in rax
mov    rdi, rsp         ; rdi = addr of string
syscall                ; system call

```

The list file for the program fragment would be as follows:

```

52 00000013 4831C0          xor rax, rax
53 00000016 50          push rax
54 00000017 48BB2F2F62696E2F73    mov rbx, 0x68732f6e69622f2f
55 00000017 68
56 00000021 53          push rbx
57 00000022 B03B       mov al, 59
58 00000024 4889E7     mov rdi, rsp
59 00000027 0F05       syscall

```

In this revised code, there are no NULL's and the address reference is obtained from the stack pointer (**rsp**) which points to the correct string.

There is an assembly language instruction **nop** which performs no operation with a machine code of 0x90. In this example, the **nop** instruction is used simply to round out the machine code to an even multiple of 8 bytes.

The series of hex values that would need to be entered is as follows:

```

0x48 0x31 0xC0 0x50 0x48 0xBB 0x2F 0x2F
0x62 0x69 0x6E 0x2F 0x73 0x68 0x53 0xB0
0x3B 0x48 0x89 0xE7 0x0F 0x05 0x90 0x90

```

While somewhat tedious, these characters can be entered by hand.

15.3 Code Injection

If the code to inject is available and can be entered, the next step would be actually getting the code executed.

Based on the previous example call frame, the code would be entered preceded by a series of **nop**'s (0x90). The exact spot where the **rip** is stored in the stack can be determined through trial and error. When the first byte of the 8 byte address is altered, the program will not be able to return to the calling routine and will likely crash. If the bytes of the **rbp** are corrupted, the program may fail in some way, but it will be different than the immediate crash caused by the corrupted **rip**. The code entered would be extended by 1 byte on each of many successive attempts. Finding this exact location in this manner will take patience.

Once the **rip** location has been determined, the 8 bytes that are entered there will need to be the address of where the injected code is in the stack where the user input was stored. This also would be determined through trial and error. However, the exact address of

the start of the injected code is not required. Starting anywhere within the preceding **nop**'s would be sufficient. This is referred to as a NOP slide⁴⁷ which will help “slide” the CPU's instruction execution flow to the injected code.

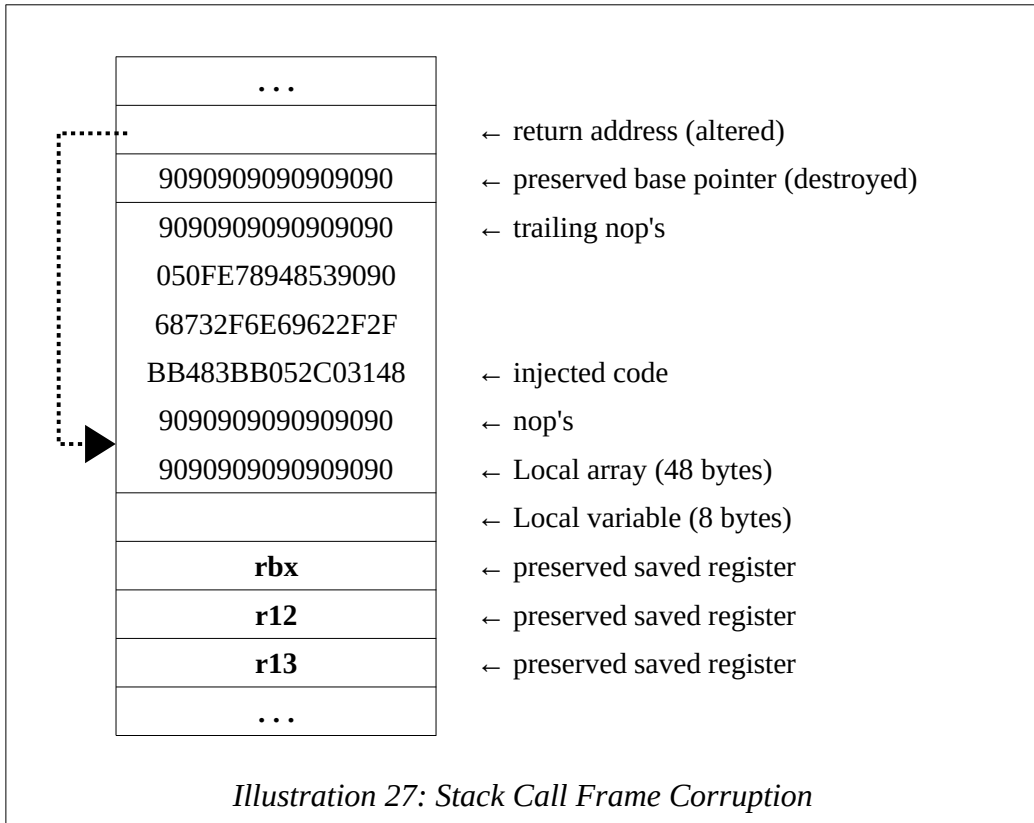

A larger local array would allow even more room for a longer NOP Slide.

15.4 Code Injection Protections

A number of methods have been developed and implemented to protect against the stack buffer overflow. Some of these methods are summarized here. It must be noted that none of these methods is completely perfect.

⁴⁷ For more information, refer to: http://en.wikipedia.org/wiki/NOP_slide

15.4.1 Data Stack Smashing Protector (or Canaries)

Data stack smashing protector, also referred to as stack canaries, is used to detect a stack buffer overflow before execution of malicious code can occur. This works by placing an integer, the value of which is randomly chosen at program start, in memory just before the return address (**rip**) in the call frame. In order to overwrite the return address, and thus execute the injected code, the canary value must also be overwritten. This canary value is checked to make sure it has not changed before a routine pops the return address.

For the GNU g++ compiler, this option (**-f-stack-protector**) is enabled by default. It can be turned off with the **-fno-stack-protector** compiler option. Turning it off would be necessary in order to perform testing using a C/C++ program of the injection techniques outlined in this chapter.

15.4.2 Data Execution Prevention

Data Execution Prevention⁴⁸ (DEP) is a security feature that marks areas of memory as either "executable" or "nonexecutable". Only code in a marked "executable" area is allowed to be executed. Code that is or injected into an area marked "nonexecutable" will not be allowed to execute. This helps prevent stack buffer overflow code injection.

15.4.3 Data Address Space Layout Randomization

Address space layout randomization (ASLR) is a technique to prevent an attacker from reliably jumping to the injected code. ASLR randomly arranges the address space positions of key data areas of a process, including the base of the executable and the positions of the stack, heap and libraries.

15.5 Exercises

Below are some quiz questions and suggested projects based on this chapter.

15.5.1 Quiz Questions

Below are some quiz questions based on this chapter.

- 1) When stack buffer overflow is caused deliberately as part of an attack it is referred as what?
- 2) What does it mean when a C function is considered unsafe?

48 For more information, refer to: http://en.wikipedia.org/wiki/Data_Execution_Prevention

- 3) Is a program that reads user input still vulnerable if the input buffer is sufficiently large (e.g., >1024 bytes)?
- 4) How might an attacker determine if an interactive program is vulnerable to a buffer overflow attack?
- 5) What is a “NOP slide”?
- 6) The text example injected code to open a new shell. Provide at least one different idea for injected code that would cause problems.
- 7) Name three techniques designed to prevent stack buffer overflow attacks.

15.5.2 Suggested Projects

Below are some suggested projects based on this chapter.

- 1) Implement the second example program fragment to open a new shell. Use the debugger to execute the program and display the final results. Execute the program without the debugger and verify that a new shell is opened.
- 2) Implement the console input program from Chapter 13. Remove the code for the buffer size check. Execute the program without the debugger and ensure the appropriate input is read and that the output is displayed to the console. Verify that entering too many characters will crash the program.
- 3) Using the program from the previous question and the program fragment to open a shell, attempt to inject the code into the running program. In order to save time, print the value of the **rsp** at an appropriate location to allow the guessing of the target address significantly easier.

The code that is the hardest to debug is the code you know can't possibly be wrong.

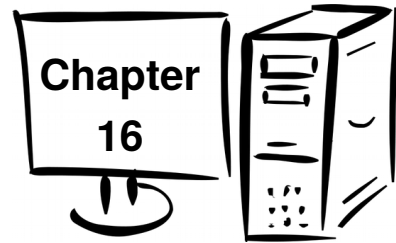

16.0 Command Line Arguments

This chapter provides a summary of how the operating system handles command line arguments and how assembly language routines can access the arguments.

The term command line arguments is used to refer to the characters, if any, entered on the command line after the program name. The command line arguments are often used by programs to provide information or parameters to the program without the need for the I/O associated with interactive prompting. Of course, if the parameters are not correct, the entire line must be re-entered.

Command line arguments were used by the assembler and linker to provide information for input files, output files, and various other options.

16.1 Parsing Command Line Arguments

The operating system is responsible for parsing, or reading, the command line arguments and deliver the information to the program. It is the responsibility of the program to determine what is considered correct and incorrect. When reading the command line, the operating system will consider an argument a set of non-space characters (i.e., a string). The space or spaces between arguments is removed or ignored by the operating system. In addition, the program name itself is considered the first, and possibly only, argument. If other arguments are entered, at least one space is required between each argument.

All arguments are delivered to the program as character strings, even number information. If needed, the program must convert the character data into the number value (float or integer) if needed.

For example, executing the program **expProg** with the following command line arguments:

```
./expProg one 42 three
```

will result four arguments as follows:

1. `./expProg`
2. `one`
3. `42`
4. `three`

The command line arguments are delivered to the program as parameters. As such, the program is like a function being called by the operating system. So, the standard calling convention is used to convey the parameters.

16.2 High-Level Language Example

In general, it is assumed that the reader is already familiar with the basic C/C++ command line handling. This section presents a brief summary of the how the C/C++ language handles the delivery of command line information to the program.

The count of arguments is passed to the main program as the first integer parameter, typically called *argc*. The second parameter, typically called *argv*, is an array of addresses for each string associated with the corresponding argument.

For example, the following C++ example program will read the command line arguments and display them to the screen.

```
#include <iomanip>
#include <iostream>
using namespace std;

int main(int argc, char* argv[])
{
    string bars;
    bars.append(50, '-');

    cout << bars << endl;
    cout << "Command Line Arguments Example"
         << endl << endl;

    cout << "Total arguments provided: " <<
         argc << endl;
    cout << "The name used to start the program: "
         << argv[0] << endl;
```

```

if (argc > 1) {
    cout << endl << "The arguments are:" << endl;
    for (int n = 1; n < argc; n++)
        cout << setw(2) << n << ": " <<
            argv[n] << endl;
}

cout << endl;
cout << bars << endl;

return 0;
}

```

Assuming the program is named `argsExp`, executing this program will produce the following output:

```

./argsExp  one 34          three
-----
Command Line Arguments Example

Total arguments provided: 4
The name used to start the program: ./args

The arguments are:
 1: one
 2: 34
 3: three
-----

```

It should be noted that the parameter '34' is a string. This example simply printed the string to the console. If a parameter is to be used as a numeric value, the program must convert as required. This includes all error checking as necessary.

16.3 Argument Count and Argument Vector Table

Since the operating system will call the main program as a function, the standard calling convention applies. The argument count and the argument vector address are passed as parameters in `rdi` and `rsi` in accordance with the standard calling convention. The first argument, in `rdi`, is the integer argument count. The second argument, in `rsi`, is the argument vector table address.

Chapter 16.0 ◀ Command Line Arguments

The argument vector table is an array containing the quadword addresses of the string for each argument. Assuming the previous examples with 4 total arguments, the basic argument vector table layout is as follows:

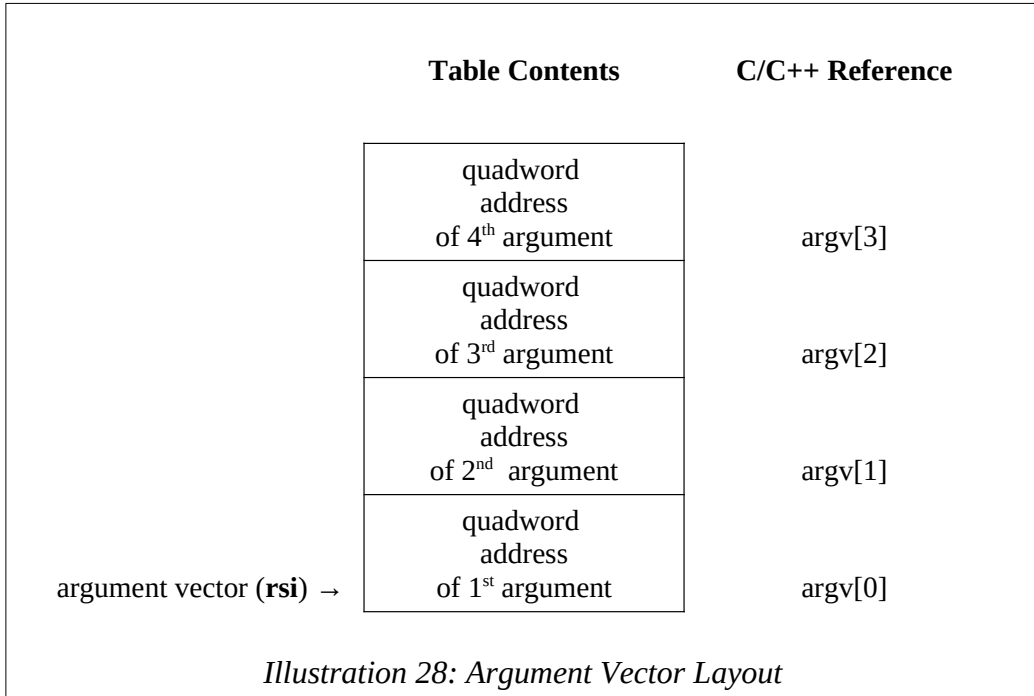

Each string is NULL terminated by the operating system and will not contain a new line character.

16.4 Assembly Language Example

An example assembly language program to read and display the command line arguments is included for reference. This example simply reads and displays the command line arguments.

```
; Command Line Arguments Example
```

```
; -----
```

```
section .data
```

```
; -----
```

```
; Define standard constants.
```



```

LF                equ    10        ; line feed
NULL              equ    0         ; end of string
TRUE              equ    1
FALSE             equ    0
EXIT_SUCCESS      equ    0         ; success code

STDIN             equ    0         ; standard input
STDOUT            equ    1         ; standard output
STDERR            equ    2         ; standard error

SYS_read          equ    0         ; read
SYS_write         equ    1         ; write
SYS_open          equ    2         ; file open
SYS_close         equ    3         ; file close
SYS_fork          equ    57        ; fork
SYS_exit          equ    60        ; terminate
SYS_creat         equ    85        ; file open/create
SYS_time          equ    201       ; get time

; -----
; Variables for main.

newLine          db      LF, NULL

; -----

section .text
global main
main:

; -----
; Get command line arguments and echo to screen.
; Based on the standard calling convention,
;     rdi = argc (argument count)
;     rsi = argv (starting address of argument vector)

    mov     r12, rdi        ; save for later use...
    mov     r13, rsi

; -----
; Simple loop to display each argument to the screen.

```

Chapter 16.0 ◀ Command Line Arguments

```
; Each argument is a NULL terminated string, so can just  
; print directly.
```

```
printArguments:
```

```
    mov    rdi, newLine  
    call  printString
```

```
    mov    rbx, 0
```

```
printLoop:
```

```
    mov    rdi, qword [r13+rbx*8]  
    call  printString
```

```
    mov    rdi, newLine  
    call  printString
```

```
    inc    rbx  
    cmp    rbx, r12  
    jl    printLoop
```

```
; -----  
; Example program done.
```

```
exampleDone:
```

```
    mov    rax, SYS_exit  
    mov    rdi, EXIT_SUCCESS  
    syscall
```

```
; *****  
; Generic procedure to display a string to the screen.  
; String must be NULL terminated.  
; Algorithm:  
; Count characters in string (excluding NULL)  
; Use syscall to output characters  
; Arguments:  
;     1) address, string  
; Returns:  
;     nothing
```

```
global printString
```

```
printString:
```

```
    push  rbp  
    mov   rbp, rsp
```

```

    push    rbx

; -----
; Count characters in string.

    mov     rbx, rdi
    mov     rdx, 0
strCountLoop:
    cmp     byte [rbx], NULL
    je      strCountDone
    inc     rdx
    inc     rbx
    jmp     strCountLoop
strCountDone:

    cmp     rdx, 0
    je      prtDone

; -----
; Call OS to output string.

    mov     eax, SYS_write           ; code for write()
    mov     rsi, rdi                ; addr of characters
    mov     edi, STDOUT             ; file descriptor
                                           ; count set above
    syscall                          ; system call

; -----
; String printed, return to calling routine.

prtDone:
    pop     rbx
    pop     rbp
    ret

; *****

```

The *printString()* function is repeated in this example and is unchanged from the previous examples.

It must be noted that in order for this to work, the program should be assembled as usual but linked with the GNU C compiler, either GCC or G++. For example, assuming this

Chapter 16.0 ◀ Command Line Arguments

example program is named `cmdLine.asm`, the assembly and linking would be as follows:

```
yasm -g dwarf2 -f elf64 cmdLine.asm -l cmdLine.lst
gcc -g -o cmdLine cmdLine.o
```

Note, Ubuntu 18 will require the **no-pie** option on the `gcc` command as shown:

```
gcc -g -no-pie -o cmdLine cmdLine.o
```

If the standard linker is used, the arguments will not be passed in the correct manner.

16.5 Exercises

Below are some quiz questions and suggested projects based on this chapter.

16.5.1 Quiz Questions

Below are some quiz questions based on this chapter.

- 1) What software entity is responsible for parsing or reading the command line arguments?
- 2) What software entity is responsible verifying or checking the command line arguments?
- 3) What is the first command line argument?
- 4) Explain what **argc** and **argv** refer to.
- 5) In an assembly language program, where is **argc** passed to the program?
- 6) In an assembly language program, where is **argv** passed to the program?
- 7) If seven spaces are entered between each of the command line arguments, how are the spaces removed when the command line arguments are checked?
- 8) If a number is expected as a command line argument, and the user enters “12x3” (an invalid value), is an error generated by the operating system (i.e., the loader)?

16.5.2 Suggested Projects

Below are some suggested projects based on this chapter.

- 1) Implement the example program to read and display the command line arguments. Use the debugger to execute the program and display the final results. Execute the program without the debugger and verify the appropriate output is displayed to the console.
- 2) Convert the command line example into a function that will display each of the command line arguments to the console. Use the debugger as necessary to debug the program. Execute the program without the debugger and verify the appropriate output is displayed to the console.
- 3) Create an assembly language program to accept a file name on the command line and open the file and display the one line message contained in the file. A series of small text file should be created each containing one of the very important messages at the start of each chapter of this text. The program should perform error checking on the file name, and if valid, open the file. If the file opens successfully, the message should be read from the file displayed to the console. Appropriate error messages should be displayed if the file cannot be opened or read. The program may assume that each message will be < 256 characters. Use the debugger as necessary to debug the program. Execute the program without the debugger and verify the appropriate output is displayed to the console.
- 4) Create an assembly language program that will accept three unsigned integers numbers from the command line, add the three numbers, and display each of the three original numbers and the sum. If too many or too few command line arguments are provided, an error message should be displayed. This program will require that each of the three ASCII strings be converted into integer. Appropriate error checking should be included. For example, “123” is correct while “12a3” is incorrect. The main program should call functions as necessary for the ASCII to integer conversion and the output. Use the debugger as necessary to debug the program. Execute the program without the debugger and verify the appropriate output is displayed to the console.

*If I had it all to do over again, I'd spell creat
with an "e".*
- Kernighan

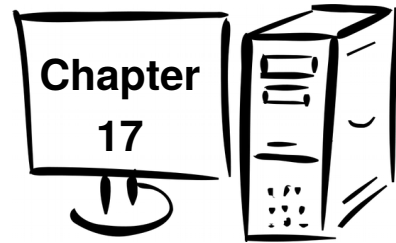

17.0 Input/Output Buffering

This chapter provides information regarding Input/Output (I/O) buffering. I/O Buffering is a process that improves the overall throughput and efficiency of I/O operations. The general topic of I/O buffering is quite broad and can encompass many things including hardware, software, and data networking. This text addresses single buffer buffering for reading information from a file. While this is a very specific application, the general concepts regarding how and why buffering is performed apply generally to many different applications.

High-level languages provide library functions that perform the I/O buffering and hide the associated complexity from the programmer. This is very desirable when programming. When working at a low-level, the buffering will need to be implemented explicitly (by us). The goal is to provide a detailed understanding of why and how buffering is performed in order to provide a more in-depth understanding of how a computer operates. This should help displace notions that such I/O is magic. And, of course, help us appreciate the compiler I/O library functions.

17.1 Why Buffer

In order to fully understand the importance of buffering, it is useful to review the memory hierarchy as outlined in Chapter 2, Architecture. As noted, accesses to secondary storage are significantly more expensive in terms of run-time than accesses to main memory. This would strongly encourage us to limit the number of secondary storage accesses by using some temporary storage, referred to as a buffer, in main memory.

Such a buffer would also help reduce the overhead associated with system calls. For example, a file read system call would involve pausing our program and turning over control to the OS. The OS would validate our request (e.g., ensure file descriptor is valid) and then pass the request to the secondary storage control via the system bus. The

controller would be whatever is necessary to obtain the requested data and place it where directly into main memory location as directed by the OS again accessing the system bus to perform the transfer. *Note*, this is referred to as Direct Memory Addressing⁴⁹ (DMA). Once the secondary storage controller has completed the transfer, it notifies the OS. The OS will then notify and resume our program. This process represents system overhead since our program is just waiting completion of the system service request. It would make sense to obtain more data rather than less data on each system service call. It should be fairly obvious that limiting the number of system service requests will help the overall performance of our program.

Additionally, as described in Chapter 13, System Services, the low-level file read and write operations require the number of characters to read. A typical operation desired by a programmer would be to read a line as is provided by high-level language functions such as the C++ `getline()` function. It is unknown ahead of time how many characters might be on that line. This makes the low-level file read operation more difficult since the exact number of characters to read is required.

We, as humans, place special meaning and significance to the LF character (end of line). In the computer, the LF is just another ASCII character, no different than any other. We see a file as a set of lines, but in the computer the file is just a collection of bytes, one after another.

The process used for reading interactive input involved reading one character at a time. This could be used to address the issue of not knowing ahead of time how many characters are on a line. As was done for interactive input, the program could just read one at a time until an LF is found and stop.

Such a process will be unduly slow for reading large volumes of information from a file. Interactive input expects the user to type characters. The computer is easily able to keep up with a human. Even the fastest typist will not be able to out-type the computer (assuming efficiently written code). Further, interactive input is generally limited to relatively small amounts. Input from a file is not awaiting user action and is generally not limited to small amounts of data. For a sufficiently large file, single character I/O would be quite slow. *Note*, testing and quantizing the performance difference is left as an exercise.

To address this, the input data will be buffered. In this context, we will read a chunk of the file, say 100,000 characters, into a large array which is referred to as a buffer or input buffer. When a “line” of text is required, the line will be obtained from the input buffer. The first time a line is requested, the file is read and the buffer is filled. After

49 For more information, refer to: http://en.wikipedia.org/wiki/Direct_memory_access

the file read completes, the line is returned from the buffer (all characters up to and including the LF). Successive calls to get the next line are satisfied by obtaining the characters from the buffer without needing to read the file again. This can keep happening until all the characters in the buffer have been returned at which point the file will need to be read again. When there are no more characters, the input is completed and the program can be terminated.

This process helps improve performance, but is more complicated. The high-level language functions, such as *getline*, hide this complexity from the user. When working at the low-level we will need to write the function to get the next line ourselves.

It is important to understand the cause of the performance degradation in order to fully understand why buffering will improve performance.

17.2 Buffering Algorithm

The first step when developing an algorithm is to understand the problem. We will assume the file is already open and available for reading. For our buffering problem, we wish to provide a *myGetLine()* function to a calling routine.

The routine might be called as follows:

```
status = myGetLine(fileDescriptor, textLine, MAXLEN);
```

The file opening and associated error checking is required but would be addressed separately and is outlined in Chapter 13, System Services. Once a file descriptor is obtained, it can be made available to the *myGetLine()* function. It is shown here as an explicit parameter for clarity.

As you may already be aware there is no special end of file code or character. We must infer the end of file based on the number of characters actually read. The file read system service will return the actual number of characters read. If the process requests 100,000 characters be read and less than 100,000 are read, the end of file has been reached and all characters have been read. Further attempts at reading the file will generate an error. While it is easy to recognize the end of file and thus the last time the file needs to be read, the remaining characters in the buffer need to be processed. So while the program may know the end of file has been found, the program must continue until the buffer is depleted.

The calling routine should not need to know any of the details regarding the buffering, buffer management, or file operations. If a line of text from the file is available, the *myGetLine()* function will return the line from the file and a TRUE status. The line is returned via the passed argument. An argument for the maximum length of the text line

is also provided to ensure that the text line array is not over-written. If a line is not available, possibly due to all lines having been already returned or an unrecoverable read error, the function should return FALSE. An unrecoverable read error might occur if the storage medium goes off-line (drive removed), the file is deleted from another console, or a hardware error occurs. Such errors will make continued reading impossible. In such an event, an error message will be displayed and a FALSE returned which will halt the program (with incomplete results).

In general, the function would read characters, up to and including the LF, from the large buffer and place them in the line buffer, named *textLine* in the above example call.

This is easily done when there are characters available in the buffer. It will require an extra step to ensure that the buffer has characters. The file must be read if the buffer is empty, either due to the very first call or when all characters in the buffer have been returned. It is possible to check if characters are available by checking the current location of the next character to read in the buffer against the buffer size. The current location cannot be allowed to exceed the buffer size (or we would be accessing a location past the end of the buffer array). This is fairly straightforward when the buffer is filled entirely. The buffer may be partially filled due to a file size smaller than the buffer size or on the last file read after a series of file reads. To address this, the end of the buffer, initially set to the buffer size, must be set based on the actual number of characters read. There is a special case when the number of characters in the file is an exact multiple of the buffer size. If this occurs, the returned number of characters read is 0. An additional check is required to address this possibility.

Now that the problem and all the associated subtle issues are understood, we can take the next step of developing an algorithm. In general this process is typically iterative. That is, a first cut is developed, reviewed and refined. This would occur multiple times until a comprehensive algorithm is obtained. While some try to rush through this step, it is a mistake. Saving minutes on the algorithm development step means extra hours of debugging.

Based on this earlier example, the passed arguments include;

```
; file descriptor → file descriptor for open file,  
; as required for read system service  
; text line → starting address of  
; max length → maximum length of the array for  
; the text line
```

Some local variables are required and defined as follows:

```

; BUFFER_SIZE → parameter for size of buffer
; currIndex → index for current location in
;   the buffer, initially set to BUFFER_SIZE
; buffMaximum → current maximum size of buffer,
;   initially set to BUFFER_SIZE
; eofFlag → boolean to mark if the end of file
;   has been found, initially set to false

```

Based on the problem understanding a number of different algorithmic approach are possible. Using the arguments and local variables, one such approach is presented for reference.

```

; myGetLine(fileDescriptor, textLine, maxLength) {
;   repeat {
;     if current index ≥ buffer maximum
;       read buffer (buffer size)
;     if error
;       handle read error
;       display error message
;       exit routine (with false)
;     reset pointers
;     if chars read < characters request read
;       set eofFlag = TRUE
;     get one character from buffer at current index
;     place character in text line buffer
;     increment current index
;     if character is LF
;       exit with true
;   }
; }

```

This algorithm outline does not verify that the text line buffer is not overwritten nor does it handle the case when the file size is an exact multiple of the buffer size. Refining, implementing, and testing the algorithm is left to the reader as an exercise.

As presented, this algorithm will require statically declared variables. Stack dynamic variables cannot be used here since the information is required to be maintained between successive calls.

The variables and algorithm are provided as program comments. The algorithm is the most important part of the program documentation and will not only help when writing the code but in the debugging process. Whatever time you think you are saving by skipping the documentation, it will cost far far more time when debugging.

17.3 Exercises

Below are some quiz questions and suggested projects based on this chapter.

17.3.1 Quiz Questions

Below are some quiz questions based on this chapter.

- 1) What is the end of line character or characters for Linux and Windows?
- 2) Based on the explanations in this chapter, what is I/O buffering?
- 3) In reference to a high-level language, where are the I/O buffering routines located?
- 4) What is the advantage of hiding the I/O buffering complexity from the programmer?
- 5) What is the key advantage of performing I/O buffering (as opposed to reading one character at a time)?
- 6) Why is it difficult to use the file read system service to read one text line from a file?
- 7) In terms of the memory hierarchy, why is buffering advantageous?
- 8) In terms of system overhead, why is buffering advantageous?
- 9) Why does the file read buffering algorithm require statically declared variables?
- 10) How is the end of file recognized by the program?
- 11) Provide one, of many, reasons that a file read request might return an error even when the file has been opened successfully.
- 12) What must be done to address the case when the file size is an exact multiple of the buffer size?
- 13) Why is the maximum length of the text line passed as an argument?
- 14) How does the presented algorithm ensure that the very first call the *myGetLine()* will read the buffer?

17.3.2 Suggested Projects

Below are some suggested projects based on this chapter.

- 1) Refine the presented algorithm to address maximum text line check and possibility that the file size is an even multiple of the buffer size. This includes formalizing the variable names and looping constructs (many possible choices).
- 2) Create a simple main program that will test the *myGetLine()* function by opening a file, calling the *myGetLine()* function, and displaying the lines to the console. Test the program with a series of different size files including ones smaller, larger, and much larger than the selected buffer size. Capture the program output and compare the captured output to the original file to ensure your program is correct.
- 3) Create a program that will read two file names from the command line, read lines from the first file, add line numbers, and write the modified line (with the line number) to the second file. For example, your add lines program might be initiated with:

```
./addLine inFile.txt newFile.txt
```

where the *inFile.txt* exists and contains standard ASCII text. If the *inFile.txt* does not exist an error should be generated and the program terminated. The program should open/create the file *newFile.txt* and write the lines, with the line numbers, to the *newFile.txt* file. The output file should be created, deleting an old version if one exists. Use a text editor to verify that the line numbers track correctly in the output file.

To err is human; to make a real mess, you need a computer.

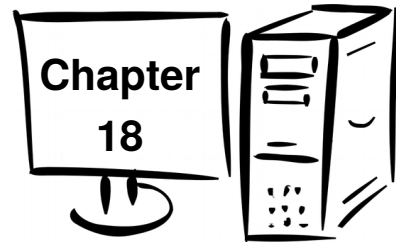

18.0 Floating-Point Instructions

This chapter provides a basic overview for a subset of the x86-64 floating-point instructions. Only the most basic instructions are covered.

The text focuses on the x86-64 floating-point operations, which are not the same as the 32-bit floating-point operations.

The instructions are presented in the following order:

- Data Movement
- Integer / Floating-point Conversion Instructions
- Arithmetic Instructions
- Floating-point Control Instructions

A complete listing of the instructions covered in this text is located in Appendix B for reference.

It should be noted that the floating-point arithmetic operations do not require the use of a specific register and do not change types (sizes). This makes the floating-point instructions easier to use.

18.1 Floating-Point Values

Floating-point values are typically represented as either single precision (32-bits) or double precision (64-bits). In C and C++ single precision floating-point variables are typically declared as ***float*** type and double precision floating-point variables are declared as ***double*** type. As noted in the following sections, assembly language instructions will use an **s** (lower-case letter S) qualifier to refer to single precision and a **d** (lower-case letter D) qualifier to refer to double precision.

18.2 Floating-Point Registers

There are a set of dedicated registers, referred to as XMM registers, used to support floating-point operations. Floating-point operations must use the floating-point registers. The XMM registers are 128-bits and 256-bits on the later processors. Initially, we will only use the lower 32 or 64-bits.

There are 16 XMM registers, named `xmm0` through `xmm15`. Refer to Chapter 2 for an explanation and summary of the CPU registers.

18.3 Data Movement

Typically, data must be moved into a CPU floating-point register in order to be operated upon. Once the calculations are completed, the result may be copied from the register and placed into a variable. There are a number of simple formulas in the example program that perform these steps. This basic data movement operations are performed with the move instruction.

The general form of the move instruction is:

```

movss    <dest>, <src>
movsd    <dest>, <src>

```

For the `movss` instruction, a single 32-bit source operand is copied into the destination operand. For the `movsd` instruction, a single 64-bit source operand is copied into the destination operand. The value of the source operand is unchanged. The destination and source operand must be of the correct size for the instruction (32 or 64-bits). Neither operand can be an immediate value. Both operands, cannot be memory, however one can be. If a memory to memory operation is required, two instructions must be used.

The move instruction loads one value, using the lower 32 or 64-bits, into or out of the register. Other move instructions are required to load multiple values.

The floating-point move instructions are summarized as follows:

| Instruction | Explanation |
|--|--|
| <code>movss <dest>, <src></code> | Copy 32-bit source operand to the 32-bit destination operand. <i>Note 1</i> , both operands cannot be memory. <i>Note 2</i> , operands cannot be an immediate. |

| Instruction | Explanation |
|----------------------------|--|
| Examples: | <pre>movss xmm0, dword [x] movss dword [fltSVar], xmm1 movss xmm3, xmm2</pre> |
| movsd <dest>, <src> | Copy 64-bit source operand to the 64-bit destination operand. <i>Note 1</i> , both operands cannot be memory. <i>Note 2</i> , operands cannot be an immediate. |
| Examples: | <pre>movsd xmm0, qword [y] movsd qword [fltDVar], xmm1 movsd xmm3, xmm2</pre> |

A more complete list of the instructions is located in Appendix B.

For example, assuming the following data declarations:

```
fsVar1    dd    3.14
fsVar2    dd    0.0
fDVar1    dq    6.28
fDVar2    dq    0.0
```

To perform, the basic operations of:

```
fsVar2 = fsVar2          ; single precision variables
fDVar2 = fDVar1         ; double precision variables
```

The following instructions could be used:

```
movss    xmm0, dword [fsVar1]
movss    dword [fsVar2], xmm0      ; fsVar2 = fsVar1

movsd    xmm1, qword [fDVar1]
movsd    qword [fDVar2], xmm1     ; fDVar2 = fDVar1

movss    xmm2, xmm0               ; xmm2 = xmm0 (32-bit)
movsd    xmm3, xmm1               ; xmm3 = xmm1 (64-bit)
```

For some instructions, including those above, the explicit type specification (e.g., *byte*, *word*, *dword*, *qword*) can be omitted as the other operand will clearly define the size. It is included for consistency and good programming practices.

18.4 Integer / Floating-Point Conversion Instructions

If integer values are required during floating-point calculations, the integers must be converted into floating-point values. If single precision and double precision floating-point values are required for a series of calculations, they must be converted to single or double so that the operations are performed on a consistent size/type.

Refer to Chapter 3 for a more detailed explanation of the representation details for floating-point values. It is assumed the reader understands the representation details and recognizes the requirement to ensure consistent formats before performing floating operations.

This basic data conversion operations are performed with the convert instruction.

The floating-point conversion instructions are summarized as follows:

| Instruction | Explanation |
|---------------------------------|--|
| cvtss2sd <RXdest>, <src> | Convert 32-bit floating-point source operand to the 64-bit floating-point destination operand. <i>Note 1</i> , destination operand must be floating-point register. <i>Note 2</i> , source operand cannot be an immediate. |
| Examples: | cvtss2sd xmm0, dword [fltSVar] cvtss2sd xmm3, eax cvtss2sd xmm3, xmm2 |
| cvtsd2ss <RXdest>, <src> | Convert 64-bit floating-point source operand to the 32-bit floating-point destination operand. <i>Note 1</i> , destination operand must be floating-point register. <i>Note 2</i> , source operand cannot be an immediate. |
| Examples: | cvtsd2ss xmm0, qword [fltDVar] cvtsd2ss xmm1, rax cvtsd2ss xmm3, xmm2 |

| Instruction | Explanation |
|---------------------------------|---|
| cvts2si <reg>, <src> | Convert 32-bit floating-point source operand to the 32-bit integer destination operand. <i>Note 1</i> , destination operand must be register. <i>Note 2</i> , source operand cannot be an immediate. |
| Examples: | cvts2si xmm1, xmm0 cvts2si eax, xmm0 cvts2si eax, dword [fltSVar] |
| cvtsd2si <reg>, <src> | Convert 64-bit floating-point source operand to the 32-bit integer destination operand. <i>Note 1</i> , destination operand must be register. <i>Note 2</i> , source operand cannot be an immediate. |
| Examples: | cvtsd2si xmm1, xmm0 cvtsd2si eax, xmm0 cvtsd2si eax, qword [fltDVar] |
| cvtsi2ss <RXdest>, <src> | Convert 32-bit integer source operand to the 32-bit floating-point destination operand. <i>Note 1</i> , destination operand must be floating-point register. <i>Note 2</i> , source operand cannot be an immediate. |
| Examples: | cvtsi2ss xmm0, eax cvtsi2ss xmm0, dword [fltDVar] |
| cvtsi2sd <RXdest>, <src> | Convert 32-bit integer source operand to the 64-bit floating-point destination operand. <i>Note 1</i> , destination operand must be floating-point register. <i>Note 2</i> , source operand cannot be an immediate. |
| Examples: | cvtsi2sd xmm0, eax cvtsi2sd xmm0, dword [fltDVar] |

A more complete list of the instructions is located in Appendix B.

18.5 Floating-Point Arithmetic Instructions

The floating-point arithmetic instructions perform arithmetic operations such as add, subtract, multiplication, and division on single or double precision floating-point values. The following sections present the basic arithmetic operations.

18.5.1 Floating-Point Addition

The general form of the floating-point addition instructions are as follows:

```
addss    <RXdest>, <src>
addsd    <RXdest>, <src>
```

Where operation is as follows:

$$\langle \text{RXdest} \rangle = \langle \text{RXdest} \rangle + \langle \text{src} \rangle$$

Specifically, the source and destination operands are added and the result is placed in the destination operand (over-writing the previous value). The destination operand must be a floating-point register. The source operand may not be an immediate value. The value of the source operand is unchanged. The destination and source operand must be of the same size (double-words or quadwords). If a memory to memory addition operation is required, two instructions must be used.

For example, assuming the following data declarations:

```
fSNum1    dd    43.75
fSNum2    dd    15.5
fSAns     dd    0.0

fDNum3    dq    200.12
fDNum4    dq    73.2134
fDAns     dq    0.0
```

To perform, the basic operations of:

```
fSAns = fSNum1 + fSNum2
fDAns = fDNum3 + fDNum4
```

The following instructions could be used:

```
; fSAns = fSNum1 + fSNum2
```

```

movss    xmm0, dword [fSNum1]
addss    xmm0, dword [fSNum2]
movss    dword [dfSAns], xmm0

; fDAns = fDNum3 + fDNum4
movsd    xmm0, qword [fDNum1]
addsd    xmm0, qword [fDNum2]
movsd    qword [fDAns], xmm0

```

For some instructions, including those above, the explicit type specification (e.g., *dword*, *qword*) can be omitted as the other operand or the instruction itself clearly defines the size. It is included for consistency and good programming practices.

The floating-point addition instructions are summarized as follows:

| Instruction | Explanation |
|------------------------------|---|
| addss <RXdest>, <src> | Add two 32-bit floating-point operands, (<RXdest> + <src>) and place the result in <RXdest> (over-writing previous value). <i>Note 1</i> , destination operands must be a floating-point register. <i>Note 2</i> , source operand cannot be an immediate. |
| Examples: | addss xmm0, xmm3 addss xmm5, dword [fSVar] |
| addsd <RXdest>, <src> | Add two 64-bit floating-point operands, (<RXdest> + <src>) and place the result in <RXdest> (over-writing previous value). <i>Note 1</i> , destination operands must be a floating-point register. <i>Note 2</i> , source operand cannot be an immediate. |
| Examples: | addsd xmm0, xmm3 addsd xmm5, qword [fDVar] |

A more complete list of the instructions is located in Appendix B.

18.5.2 Floating-Point Subtraction

The general form of the floating-point subtraction instructions are as follows:

```

subss    <RXdest>, <src>
subsd    <RXdest>, <src>

```

Where operation is as follows:

$$\langle \text{RXdest} \rangle = \langle \text{RXdest} \rangle - \langle \text{src} \rangle$$

Specifically, the source and destination operands are subtracted and the result is placed in the destination operand (over-writing the previous value). The destination operand must be a floating-point register. The source operand may not be an immediate value. The value of the source operand is unchanged. The destination and source operand must be of the same size (double-words or quadwords). If a memory to memory addition operation is required, two instructions must be used.

For example, assuming the following data declarations:

```

fSNum1    dd      43.75
fSNum2    dd      15.5
fSAns     dd      0.0

fDNum3    dq      200.12
fDNum4    dq      73.2134
fDAns     dq      0.0

```

To perform, the basic operations of:

```

fSAns = fSNum1 - fSNum2
fDAns = fDNum3 - fDNum4

```

The following instructions could be used:

```

; fSAns = fSNum1 - fSNum2
movss    xmm0, dword [fSNum1]
subss    xmm0, dword [fSNum2]
movss    dword [fSAns], xmm0

; fDAns = fDNum3 - fDNum4
movsd    xmm0, qword [fDNum1]
subsd    xmm0, qword [fDNum2]
movsd    qword [fDAns], xmm0

```

For some instructions, including those above, the explicit type specification (e.g., *dword*, *qword*) can be omitted as the other operand or the instruction itself clearly defines the size. It is included for consistency and good programming practices.

The floating-point subtraction instructions are summarized as follows:

| Instruction | Explanation |
|------------------------------|--|
| subss <RXdest>, <src> | Subtract two 32-bit floating-point operands, (<RXdest> - <src>) and place the result in <RXdest> (over-writing previous value). <i>Note 1</i> , destination operands must be a floating-point register. <i>Note 2</i> , source operand cannot be an immediate. |
| Examples: | subss xmm0, xmm3 subss xmm5, dword [fSVar] |
| subsd <RXdest>, <src> | Subtract two 64-bit floating-point operands, (<RXdest> - <src>) and place the result in <RXdest> (over-writing previous value). <i>Note 1</i> , destination operands must be a floating-point register. <i>Note 2</i> , source operand cannot be an immediate. |
| Examples: | subsd xmm0, xmm3 subsd xmm5, qword [fDVar] |

A more complete list of the instructions is located in Appendix B.

18.5.3 Floating-Point Multiplication

The general form of the floating-point multiplication instructions are as follows:

```

mulss    <RXdest>, <src>
mulsd    <RXdest>, <src>

```

Where operation is as follows:

```

<RXdest> = <RXdest> * <src>

```

Chapter 18.0 ◀ Floating-Point Instructions

Specifically, the source and destination operands are multiplied and the result is placed in the destination operand (over-writing the previous value). The destination operand must be a floating-point register. The source operand may not be an immediate value. The value of the source operand is unchanged. The destination and source operand must be of the same size (double-words or quadwords). If a memory to memory addition operation is required, two instructions must be used.

For example, assuming the following data declarations:

```
fSNum1    dd    43.75
fSNum2    dd    15.5
fSAns     dd    0.0

fDNum3    dq    200.12
fDNum4    dq    73.2134
fDAns     dq    0.0
```

To perform, the basic operations of:

```
fSAns = fSNum1 * fSNum2
fDAns = fDNum3 * fDNum4
```

The following instructions could be used:

```
; fSAns = fSNum1 * fSNum2
movss    xmm0, dword [fSNum1]
mulss    xmm0, dword [fSNum2]
movss    dword [fSAns], xmm0

; fDAns = fDNum3 * fDNum4
movsd    xmm0, qword [fDNum1]
mulsd    xmm0, qword [fDNum2]
movsd    qword [fDAns], xmm0
```

For some instructions, including those above, the explicit type specification (e.g., *dword*, *qword*) can be omitted as the other operand or the instruction itself clearly defines the size. It is included for consistency and good programming practices.

The floating-point multiplication instructions are summarized as follows:

| Instruction | Explanation |
|------------------------------|--|
| mulss <RXdest>, <src> | Multiply two 32-bit floating-point operands, (<RXdest> * <src>) and place the result in <RXdest> (over-writing previous value). <i>Note 1</i> , destination operands must be a floating-point register. <i>Note 2</i> , source operand cannot be an immediate. |
| Examples: | mulss xmm0, xmm3 mulss xmm5, dword [fSVar] |
| mulsd <RXdest>, <src> | Multiply two 64-bit floating-point operands, (<RXdest> * <src>) and place the result in <RXdest> (over-writing previous value). <i>Note 1</i> , destination operands must be a floating-point register. <i>Note 2</i> , source operand cannot be an immediate. |
| Examples: | mulsd xmm0, xmm3 mulsd xmm5, qword [fDVar] |

A more complete list of the instructions is located in Appendix B.

18.5.4 Floating-Point Division

The general form of the floating-point division instructions are as follows:

```
divss    <RXdest>, <src>
divsd    <RXdest>, <src>
```

Where operation is as follows:

$$\langle \text{RXdest} \rangle = \langle \text{RXdest} \rangle / \langle \text{src} \rangle$$

Specifically, the source and destination operands are divided and the result is placed in the destination operand (over-writing the previous value). The destination operand must be a floating-point register. The source operand may not be an immediate value. The value of the source operand is unchanged. The destination and source operand must be

Chapter 18.0 ◀ Floating-Point Instructions

of the same size (double-words or quadwords). If a memory to memory addition operation is required, two instructions must be used.

For example, assuming the following data declarations:

```
fSNum1    dd    43.75
fSNum2    dd    15.5
fSAns     dd    0.0

fDNum3    dq    200.12
fDNum4    dq    73.2134
fDAns     dq    0.0
```

To perform, the basic operations of:

```
fSAns = fSNum1 / fSNum2
fDAns = fDNum3 / fDNum4
```

The following instructions could be used:

```
; fSAns = fSNum1 / fSNum2
movss    xmm0, dword [fSNum1]
divss    xmm0, dword [fSNum2]
movss    dword [fSAns], xmm0

; fDAns = fDNum3 / fDNum4
movsd    xmm0, qword [fDNum1]
divsd    xmm0, qword [fDNum2]
movsd    qword [fDAns], xmm0
```

For some instructions, including those above, the explicit type specification (e.g., *dword*, *qword*) can be omitted as the other operand or the instruction itself clearly defines the size. It is included for consistency and good programming practices.

The floating-point division instructions are summarized as follows:

| Instruction | Explanation |
|------------------------------|--|
| divss <RXdest>, <src> | Divide two 32-bit floating-point operands, (<RXdest> / <src>) and place the result in <RXdest> (over-writing previous value). <i>Note 1</i> , destination operands must be a floating-point register. <i>Note 2</i> , source operand cannot be an immediate. |
| Examples: | divss xmm0, xmm3 divss xmm5, dword [fSVar] |
| divsd <RXdest>, <src> | Divide two 64-bit floating-point operands, (<RXdest> / <src>) and place the result in <RXdest> (over-writing previous value). <i>Note 1</i> , destination operands must be a floating-point register. <i>Note 2</i> , source operand cannot be an immediate. |
| Examples: | divsd xmm0, xmm3 divsd xmm5, qword [fDVar] |

A more complete list of the instructions is located in Appendix B.

18.5.5 Floating-Point Square Root

The general form of the floating-point square root instructions are as follows:

```
sqrtps    <RXdest>, <src>
sqrtsd    <RXdest>, <src>
```

Where operation is as follows:

$$\langle \text{dest} \rangle = \sqrt{\langle \text{src} \rangle}$$

Specifically, the square root of the source operand is placed in the destination operand (over-writing the previous value). The destination operand must be a floating-point register. The source operand may not be an immediate value. The value of the source operand is unchanged. The destination and source operand must be of the same size

(double-words or quadwords). If a memory to memory addition operation is required, two instructions must be used.

For example, assuming the following data declarations:

```
fSNum1    dd    1213.0
fSAns     dd    0.0

fDNum3    dq    172935.123
fDAns     dq    0.0
```

To perform, the basic operations of:

$$\text{fSAns} = \sqrt{\text{fSNum1}}$$

$$\text{fDAns} = \sqrt{\text{fSNum3}}$$

The following instructions could be used:

```
; fSAns = sqrt (fSNum1)
sqrtss    xmm0, dword [fSNum1]
movss     dword [fSAns], xmm0

; fDAns = sqrt(fDNum3)
sqrtsd    xmm0, qword [fDNum3]
movsd     qword [fDAns], xmm0
```

For some instructions, including those above, the explicit type specification (e.g., *dword*, *qword*) can be omitted as the other operand or the instruction itself clearly defines the size. It is included for consistency and good programming practices.

The floating-point addition instructions are summarized as follows:

| Instruction | Explanation |
|---|---|
| <pre>sqrtss <RXdest>, <src></pre> | <p>Take the square root of the 32-bit floating-point source operand and place the result in destination operand (over-writing previous value).</p> <p><i>Note 1</i>, destination operands must be a floating-point register.</p> <p><i>Note 2</i>, source operand cannot be an immediate.</p> |

| Instruction | Explanation |
|-------------------------------|---|
| Examples: | <pre>sqrtss xmm0, xmm3 sqrtss xmm7, dword [fSVar]</pre> |
| sqrtss <RXdest>, <src> | <p>Take the square root of the 64-bit floating-point source operand and place the result in destination operand (over-writing previous value).</p> <p><i>Note 1</i>, destination operands must be a floating-point register.</p> <p><i>Note 2</i>, source operand cannot be an immediate.</p> |
| Examples: | <pre>sqrtss xmm0, xmm3 sqrtss xmm7, qword [fDVar]</pre> |

A more complete list of the instructions is located in Appendix B.

18.6 Floating-Point Control Instructions

The control instructions refer to programming constructs such as IF statements and looping. The integer comparison instruction, **cmp**, as described in Chapter 7 will not work for floating-point values.

The floating-point comparison instructions compare two floating-point values. Like the integer comparisons, the result of the comparison is stored in the **rFlag** register and neither operand is changed. Immediately after the comparison, the **rFlag** register is accessed to determine the results by using a conditional jump instruction. While all floating-point comparisons are signed, an unsigned conditional jump is used (**ja/jae/jb/jbe**). Program labels (i.e., a target of a conditional jump) are the same.

There are two forms of the floating-point comparison, ordered and unordered. The ordered floating-point comparisons can cause a number of exceptions. The unordered floating-point comparisons can only cause an exception for a *S-NaN* (signaling not a number), more generically referred to as a *NaN* (not a number) as described in Chapter 3, Data Representation.

The GNU C/C++ compiler favors the unordered floating-point compare instruction. Since they are similar, this text will focus only on the unordered version.

18.6.1 Floating-Point Comparison

The general form of the floating-point comparison instructions are as follows:

```
ucomiss    <RXsrc>, <src>
ucomisd    <RXsrc>, <src>
```

Where **<RXsrc>** and **<src>** are compared as floating-point values and must be the same size. The results of the comparison are placed in the **rFlag** register. Neither operand is changed. The **<RXsrc>** operand must be one of the **xmm** registers. The **<src>** register can be a **xmm** register or a memory location, but may not be an immediate value. One of the unsigned conditional jump instructions can be used to read the **rFlag** register.

The conditional control instructions include the jump equal (**je**) and jump not equal (**jne**). The unsigned conditional control instructions include the basic set of comparison operations; jump below than (**jb**), jump below or equal (**jbe**), jump above than (**ja**), and jump above or equal (**jae**).

The general form of the signed conditional instructions along with an explanatory comment are as follows:

```
je    <label>          ; if <op1> == <op2>
jne   <label>          ; if <op1> != <op2>

jb    <label>          ; unsigned, if <op1> < <op2>
jbe   <label>          ; unsigned, if <op1> <= <op2>
ja    <label>          ; unsigned, if <op1> > <op2>
jae   <label>          ; unsigned, if <op1> >= <op2>
```

For example, given the following pseudo-code for floating-point variables:

```
if (fltNum > fltMax)
    fltMax = fltNum;
```

And, assuming the following data declarations:

```
fltNum    dq    7.5
fltMax    dq    5.25
```

Assuming that the values are updating appropriately within the program (not shown), the following instructions could be used:

```
movsd    xmm1, qword [fltNum]
ucomisd   xmm1, qword [fltMax]    ; if fltNum <= fltMax
```

```

    jbe      notNewFltMax          ; skip set new max
    movsd   qword [fltMax], xmm1
notNewFltMax:

```

As with integer comparisons, the floating-point compare and conditional jump provide functionality for jump or not jump. As such, if the condition from the original IF statement is false, the code to update the **fltMax** should not be executed. Thus, when false, in order to skip the execution, the conditional jump will jump to the target label immediately following the code to be skipped (not executed). While there is only one line in this example, there can be many lines of code.

A more complex example might be as follows:

```

    if (x != 0.0) {
        ans = x / y;
        errFlg = FALSE;
    } else {
        errFlg = TRUE;
    }

```

This basic compare and conditional jump do not provide an IF-ELSE structure. It must be created. Assuming the *x* and *y* variables are signed double-words that will be set during the program execution, and the following declarations:

```

TRUE      equ      1
FALSE     equ      0
fltZero   dq       0.0
x         dq       10.1
y         dq       3.7
ans       dq       0.0
errFlg    db       FALSE

```

The following code could be used to implement the above IF-ELSE statement.

```

movsd     xmm1, qword [x]
ucomisd   xmm1, qword [fltZero]      ; if statement
je        doElse
divsd     xmm1, qword [y]
movsd     dword [ans], eax
mov       byte [errFlg], FALSE
jmp       skpElse

```

```
doElse:
    mov     byte [errFlg], TRUE
skpElse:
```

Floating-point comparisons can be very tricky due to inexact nature of the floating-point representations and rounding errors. For example, the value 0.1 added 10 times should be 1.0. However, implementing a program to perform this summation and checking the result, will show that;

$$\sum_{i=1}^{10} 0.1 \neq 1.0$$

which can be very confusing for inexperienced programmers.

For more information regarding the details of floating-point, refer to the popular article *What Every Computer Scientist Should Know about Floating Point Arithmetic*⁵⁰.

The floating-point comparison instructions are summarized as follows:

| Instruction | Explanation |
|-------------------------------|--|
| ucomiss <RXsrc>, <src> | Compare two 32-bit floating-point operands, (<RXsrct> + <src>). Results are placed in the rFlag register. Neither operand is changed. <i>Note 1</i> , <RXsrc> operands must be a floating-point register. <i>Note 2</i> , source operand may be a floating-point register or memory, but not be an immediate. |
| Examples: | ucomiss xmm0, xmm3 ucomiss xmm5, dword [fSVar] |
| ucomisd <RXsrc>, <src> | Compare two 64-bit floating-point operands, (<RXsrct> + <src>). Results are placed in the rFlag register. Neither operand is changed. <i>Note 1</i> , <RXsrc> operands must be a floating-point register. <i>Note 2</i> , source operand may be a floating-point register or memory, but not be an immediate. |

⁵⁰ See: http://docs.oracle.com/cd/E19957-01/806-3568/ncg_goldberg.html

| Instruction | Explanation |
|-------------|---|
| Examples: | <pre>ucomisd xmm0, xmm3 ucomisd xmm5, qword [fSVar]</pre> |

A more complete list of the instructions is located in Appendix B.

18.7 Floating-Point Calling Conventions

The standard calling conventions detailed in Chapter 12, Functions still fully apply. This section addresses the usage of the floating-point registers when calling floating-point functions.

When using floating-point registers, none of the registers are preserved across a floating-point function call.

The first eight (8) floating-point arguments are passed in floating-point registers **xmm0** – **xmm7**. Any additional arguments are placed on the stack in backwards order in the manner described in Chapter 12, Functions. A value returning floating-point function will return the result in **xmm0**.

Since none of the floating-point registers are preserved, the code must be written carefully.

18.8 Example Program, Sum and Average

This example is a simple assembly language program to calculate the sum and average for a list of floating-point values.

```
; Floating-Point Example Program
; *****

section .data

; -----
; Define constants.

NULL equ 0 ; end of string
TRUE equ 1
FALSE equ 0
```

Chapter 18.0 ◀ Floating-Point Instructions

```

EXIT_SUCCESS    equ 0           ; Successful operation
SYS_exit        equ 60          ; system call code for terminate

; -----

fltLst          dq 21.34, 6.15, 9.12, 10.05, 7.75
                dq 1.44, 14.50, 3.32, 75.71, 11.87
                dq 17.23, 18.25, 13.65, 24.24, 8.88
length          dd 15
lstSum          dq 0.0
lstAve          dq 0.0

; *****
section .text
global _start
_start:

; -----
; Loop to find floating-point sum.

    mov ecx, [length]
    mov rbx, fltLst
    mov rsi, 0
    movsd xmm1, qword [lstSum]

sumLp:
    movsd xmm0, qword [rbx+rsi*8]        ; get fltLst[i]
    addsd xmm1, xmm0                    ; update sum
    inc rsi                              ; i++
    loop sumLp

    movsd qword [lstSum], xmm1          ; save sum

; -----
; Compute average of entire list.

    cvtsi2sd xmm0, dword [length]
    cvtsd2si dword [length], xmm0
    divsd xmm1, xmm0
    movsd qword [lstAve], xmm1

; -----

```

```

; Done, terminate program.

last:
    mov     eax, SYS_exit
    mov     ebx, EXIT_SUCCESS           ; exit w/success
    syscall

```

The debugger can be used to examine the results and verify correct execution of the program.

18.9 Example Program, Absolute Value

This example is a simple assembly language program to calculate the sum and average for a list of floating-point values. Recall that if a value is negative, it must be made positive and if the value is already positive, nothing should be done.

```

; Floating-Point Absolute Value Example

section     .data

; -----
; Define constants.

TRUE       equ     1
FALSE      equ     0

SUCCESS    equ     0           ; successful operation
SYS_exit   equ     60         ; call code for terminate

; -----
; Define some test variables.

dZero      dq      0.0
dNegOne    dq      -1.0

fltVal     dq      -8.25

; *****
section     .text
global     _start
_start:

```

```

; -----
; Perform absolute value function on flt1

    movsd    xmm0, qword [fltVal]
    ucomisd  xmm0, qword [dZero]
    jae      isPos
    mulsd    xmm0, qword [dNegOne]
    movsd    qword [fltVal], xmm0
isPos:

; -----
; Done, terminate program.

last:
    mov     eax, SYS_exit
    mov     ebx, EXIT_SUCCESS           ; exit w/success
    syscall

```

In this example, the final result for `|fltVal|` was saved to memory. Depending on the context, this may not be required.

18.10 Exercises

Below are some quiz questions and suggested projects based on this chapter.

18.10.1 Quiz Questions

Below are some quiz questions based on this chapter.

- 1) List the floating-point registers.
- 2) How many bytes are used by single precision floating-point values and how many bytes are used for double precision floating-point values?
- 3) Explain why 0.1 added 10 times does not equal 1.0.
- 4) Where is the result of a value returning floating-point function such as **sin(x)** return the result?
- 5) For a value returning floating-point function, which floating-point registers must be preserved across the function call?

18.10.2 Suggested Projects

Below are some suggested projects based on this chapter.

- 1) Implement the example program to find the sum and average for a list of floating-point values. Use the debugger to execute the program and verify the final results.
- 2) Implement the floating-point absolute value function as two macros, one **fAbsf** for 32-bit floating-point values and **fAbsd** for 64-bit floating-point values. Create a simple main program that uses each macro three times on various different values. Use the debugger to execute the program and verify the results.
- 3) Implement a program to perform the summation:

$$\sum_{i=1}^{10} 0.1$$

Compare the results of the summation to the value 1.0 and display a message “Are Same” if the summation result equals 1.0 and the message “Are Not Same” if the result of the summation does not equal 1.0. Use the debugger as needed to debug the program. When working, execute the program without the debugger and verify that the expected results are displayed to the console.

#define QUESTION ((bb) || !(bb))
- Shakespeare

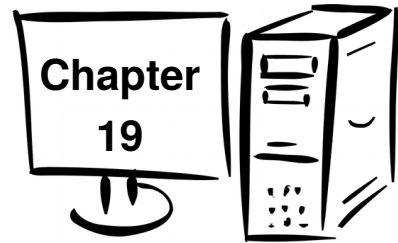

19.0 Parallel Processing

In the context of computing, parallel processing⁵¹, or more generically concurrency⁵², refers to multiple processes appearing to execute simultaneously.

In broad terms, concurrency implies multiple different (not necessarily related) processes simultaneously making progress. This can be accomplished in multiple ways. For example, process A could be executing on core 0 while process B is simultaneously executing on core 1 thus executing in parallel. Another possibility is that the execution of process A and B could be interleaved on a single core where process A might execute for a period of time and then be paused while process B is then executed for a period of time and then paused while process A is resumed. This continues until either or both are completed. If this interleaved execution is performed often and fast enough it will appear that each is executing simultaneously.

The term parallel processing implies that processes are executing simultaneously. These processes may be unrelated or working together as a coordinated unit to solve a single complex problem.

This chapter provides an overview of some basic approaches to parallel processing as applied to a single problem. Assume that a large problem can be divided into various sub-problems and those sub-problems can be executed independently. The sub-solutions would be brought together to provide a final solution for the problem. If the sub-problems can be executed simultaneously, a final solution might be found significantly faster than if the sub-problems are executed in series (one after another). The potential rewards for implementing concurrency are significant but so are the challenges. Unfortunately, not all problems can be easily divided into such sub-problems.

51 For more information, refer to: http://en.wikipedia.org/wiki/Parallel_processing

52 For more information, refer to: [http://en.wikipedia.org/wiki/Concurrency_\(computer_science\)](http://en.wikipedia.org/wiki/Concurrency_(computer_science))

The basic approaches to parallel processing are distributed computing⁵³ and multiprocessing⁵⁴ (also referred to as threaded computations). Each approach is explained with an emphasis on the technical issues associated with shared memory multiprocessing. The larger topic of learning to create parallel algorithms is outside the scope of this text.

19.1 Distributed Computing

Distributed computing or distributed processing refers to the general idea of taking a large problem, dividing it into multiple sub-problems, and executing the sub-problems on different computers connected through a network. Typically, a master or main server node will distribute the sub-problems to various available computation nodes. When completed, the computational nodes will send the intermediate results back to the master. As needed, the master may send additional sub-problems to the computational nodes. The master will also track and combine the intermediate results into a final solution. The details of how this is actually performed vary significantly and are directly related to the specifics of the problem.

There are many large scale examples of the distributed computing projects⁵⁵. One such project is Folding@home⁵⁶ which is a large distributed computing project for disease research that simulates protein folding, computational drug design, and other types of molecular dynamics. The project uses the idle processing resources of well over 100,000 different personal computers owned by volunteers who have installed the software on their systems.

This approach has the advantage of scaling to very large number of distributed computers. The disadvantages are associated with the communication limitations associated with the network.

19.2 Multiprocessing

As noted in Chapter 2, Architecture Overview, most current CPU chips include multiple cores. The CPU cores all have equal access to the main memory resource. Multiprocessing is a form of parallel processing that specifically refers to using multiple cores to perform simultaneous execution of multiple processes.

53 For more information, refer to: http://en.wikipedia.org/wiki/Distributed_computing

54 For more information, refer to: <http://en.wikipedia.org/wiki/Multiprocessing>

55 For more information, refer to: http://en.wikipedia.org/wiki/List_of_distributed_computing_projects

56 For more information, refer to: <http://en.wikipedia.org/wiki/Folding@home>

Focusing on a single large project, a main or initial process might generate subprocesses, referred to as threads⁵⁷. When the initial process is started and placed in memory by the system loader⁵⁸, the Operating System creates a new process including the required Operating System data structures, memory allocations, and page/swap file allotments. A thread is often referred to as a light-weight process since it will use the initial process's allocations and address space thus making it quicker to create. It will also be quicker to terminate as the deallocations are not performed. Since the threads share memory with the initial process and any other threads, this presents the potential for very fast communication between simultaneously executing threads. It also has the added requirement that the communications in the form of memory writes be carefully coordinated to ensure results are not corrupted. Such a problem is referred to as a race condition⁵⁹. Race conditions are addressed in the following section.

The threaded approach will not scale to the extent of the distributed approach. CPU chips have limited number of cores which places an upper bound on the number of simultaneous computations that can occur. This limit does not apply to distributed computing. The limitations regarding network communication speeds do not apply to threaded computations.

19.2.1 POSIX Threads

The POSIX Threads⁶⁰, commonly called pThreads, is a widely available thread library on Ubuntu and many other operating systems. The example in this section will use the pThreads thread library Application Programmer Interface (API) for creating and joining threads.

The initial or main process is created during the load process. The main process may create additional threads with the **pthread_create()** library function. While there is no specific limit to the number of threads that can be created, there is a limit to the number of cores available thus creating a practical limit for the number of threads.

The initial or main process can see if the thread has completed with the **pthread_join()** library function. If the thread has not completed, the join function will wait until it does. Ideally, in order to maximize the overall parallel operations, the main process would perform other computations while the thread or threads are executing and only check for thread completion when the other work has been completed.

57 For more information, refer to: [http://en.wikipedia.org/wiki/Thread_\(computing\)](http://en.wikipedia.org/wiki/Thread_(computing))

58 For more information, refer to Chapter 5, Tool Chain

59 For more information, refer to: http://en.wikipedia.org/wiki/Race_condition

60 For more information, refer to: http://en.wikipedia.org/wiki/POSIX_Threads

There are other pThread functions to address mutexes⁶¹, condition variables, and synchronization⁶² between threads which are not addressed in this very brief overview.

It should be noted that there are other approaches to threading not addressed here.

19.2.2 Race Conditions

A race condition is a generic term referring to when multiple threads simultaneously write to the same location at the same time. Threaded programming is typically done in a high-level language. However, fully understanding the specific cause of a race condition is best done at the assembly language level.

A simple example is provided to purposely create a race condition and examine the problem in detail. This example is not computationally useful.

Assuming we wish to compute the following formula MAX times, where MAX is a defined constant. For example;

$$myValue = \left(\frac{myValue}{X} \right) + Y$$

We could write a high-level language program something along the lines of:

```
for (int i=0; i < MAX; i++)
    myValue = (myValue / X) + Y;
```

If we wish to speed-up this computation, perhaps because MAX is extremely large, we might create two thread functions, each to perform MAX/2 computations. Each of the thread functions would have shared access to the variables *myValue*, *X*, and *Y*. Thus, the code might be;

```
for (int i=0; i < MAX/2; i++)
    myValue = (myValue / X) + Y;
```

This code would be repeated in each of the thread functions. It may not be obvious, but assuming both threads are simultaneously executing, this will cause a race condition on the *myValue* variable. Specifically, each of the two threads are attempting to update the variable simultaneously and some of the updates to the variable may be lost.

To further simplify this example, we will assume that *X* and *Y* are both set to 1. As such, the result of each calculation would be to increment *myValue* by 1. If *myValue* is

61 For more information, refer to: http://en.wikipedia.org/wiki/Mutual_exclusion

62 For more information, refer to: [http://en.wikipedia.org/wiki/Synchronization_\(computer_science\)](http://en.wikipedia.org/wiki/Synchronization_(computer_science))

initialized to 0, repeating the calculation MAX times, should result in *myValue* being set to MAX. This simplification will allow easy verification of the results. It is not computationally useful in any meaningful way.

Implementing this in assembly would first require a main program that creates each of the two threads. Then, each of the thread functions would need to be created. In this very simple example, each thread function would be the same (performing MAX/2 iterations and that MAX is an even number).

Assuming one of the thread functions is named *threadFunction0()* and given the below pthread thread data structure;

```
pthreadID0    dd    0, 0, 0, 0, 0
```

The following code fragment would create and start *threadFunction0()* executing.

```
; pthread_create(&pthreadID0, NULL,
;                &threadFunction0, NULL);
mov    rdi, pthreadID0
mov    rsi, NULL
mov    rdx, threadFunction0
mov    rcx, NULL
call   pthread_create
```

This would need to be performed for each thread function.

The following code fragment will check if a thread function is completed;

```
; pthread_join (pthreadID0, NULL);
mov    rdi, qword [pthreadID0]
mov    rsi, NULL
call   pthread_join
```

If the thread function is not done, the join call will wait until it is completed.

The thread function, *threadFunction0()*, itself might contain the following code;

```
; -----
global threadFunction0
threadFunction0:

; Perform MAX / 2 iterations to update myValue.

mov    rcx, MAX
```

```

shr    rcx, 1                ; divide by 2
mov    r10, qword [x]
mov    r11, qword [y]

```

```

incLoop0:
    ; myValue = (myValue / x) + y

mov    rax, qword [myValue]
cqo
div    r10
add    rax, r11
mov    qword [myValue], rax
loop  incLoop0

ret

```

The code for the second thread function would be similar.

If both threads are simultaneously executing, they are both trying to update the *myValue* variable. For example, assuming that thread function 0 is executing on core 0 and thread function 1 is executing on core 1 (arbitrarily chosen), the following execution trace is possible;

| Step | Code: Core 0, Thread 0 | Code: Core 1, Thread 1 |
|------|---------------------------------------|---------------------------------------|
| 1 | <code>mov rax, qword [myValue]</code> | |
| 2 | <code>cqo</code> | <code>mov rax, qword [myValue]</code> |
| 3 | <code>div qword [x]</code> | <code>cqo</code> |
| 4 | <code>add rax, qword [y]</code> | <code>div qword [x]</code> |
| 5 | <code>mov qword [myValue], rax</code> | <code>add rax, qword [y]</code> |
| 6 | | <code>mov qword [myValue], rax</code> |

As a reminder, each core has its own set of registers. Thus, the core 0 `rax` register is different than the core 1 `rax` register.

If the variable *myValue* is currently at 730, two thread executions should increase it to 732. On core 0 code, at step 1 the 730 is copied into core 0, `rax`. On core 2, at step 2, the 730 is copied into core 1, `rax`. As execution progresses, steps 2-4 are performed and core 0 `rax` is incremented from 730 to 731. During this time, on core 1, steps 1-3 are

completed and the 730 is also incremented to 731. As the next step, step5, is executed on core 0, the 731 is written to *myValue* variable. As the next step, step 6 is executed on core 1, the value 731 is again written to the *myValue* variable. Two executions traces should have incremented the variable twice. However, since the value was obtained in core 1 before core 0 was able to write the final value, one of the increments was lost or duplicated. The end result of this overlap is that the final value of *myValue* will not be correct. And, since the amount of overlapping execution is not predictable, the degree of incorrectness is not easily predicted and may vary between different executions.

For example, if the value of MAX is fairly small, such as 10,000, there would not likely be any overlap. Each thread would start and complete so quickly, that the chances of overlapping execution would be very small. The problem still exists but would likely appear correct on most executions, making it easy to ignore occasional anomalous output. As MAX is increased, the odds of overlapping execution increase.

Such problems can be very challenging to debug and require an understanding of the low-level operations and the technical architecture.

19.3 Exercises

Below are some quiz questions and suggested projects based on this chapter.

19.3.1 Quiz Questions

Below are some quiz questions based on this chapter.

- 1) Explain the difference between concurrency and parallel processing.
- 2) Name the two common approaches to parallel computations.
- 3) In distributed processing, where might the parallel computations take place?
- 4) Provide the names of two examples of large distributed computing projects. Include a one-sentence description of each.
- 5) In multiprocessing, where might the parallel computations take place?
- 6) Provide one advantage and one disadvantage of the distributed computing approach to parallel processing.
- 7) Provide one advantage and one disadvantage of the multiprocessing approach to parallel processing.
- 8) Explain what a race condition is?

- 9) Will a race condition occur when a shared variable is read by multiple simultaneously executing threads? Explain why or why not.
- 10) Will a race condition occur when a shared variable is written by multiple simultaneously executing threads (without any coordination)? Explain why or why not.

19.3.2 Suggested Projects

Below are some suggested projects based on this chapter.

- 1) Implement the outlined example program create two thread functions where each thread function computes the formula $MAX/2$ times. Set MAX to 1,000,000,000 (one billion).
 1. Initially, structure the main function to call the first thread function and wait until it completes until creating the second thread function and waiting until it completes. This will force the threads to execute sequentially (not in parallel). Include a function to convert the integer into a string and display the result to the console. Use the debugger as necessary to debug the program. When working, execute the program without the debugger and verify that the displayed results for results is the same as MAX .
 2. Use the Unix `time`⁶³ command to establish a base execute time. Use the total elapsed time.
 3. Restructure the program so that both threads are the created thus allowing the execution of the threads to occur in parallel. Use the debugger as necessary to debug the program. When working, execute the program without the debugger and note the final value of MAX . Ensure a fully understanding of why displayed value for MAX is incorrect. Additionally, use the Unix `time` command on the modified program verify that it uses less elapsed time.
- 2) Update the program from the previous question to resolve the race condition. Use the debugger as necessary to debug the program. One very simple way to accomplish this is to use temporary variables for each thread and combine them after both thread functions have completed and display the final combined result. When working, execute the program without the debugger and verify that the displayed results for results is the same as MAX .

63 For more information, refer to: [http://en.wikipedia.org/wiki/Time_\(Unix\)](http://en.wikipedia.org/wiki/Time_(Unix))

*If a program is useful, it must be changed.
If a program is useless, it must be
documented.*

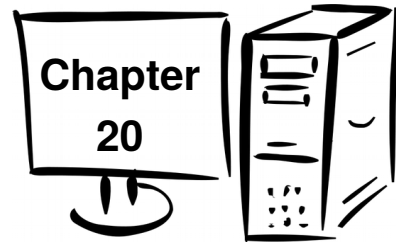

20.0 Interrupts

In a general sense, an interrupt⁶⁴ is a pause or hold in the current flow. For example, if you are talking on the phone and the door bell rings, the phone conversation is placed on hold, and the door answered. After the salesperson is sent away, the phone conversation is resumed (where the conversation left off).

In computer programming an interrupt is also a pause, or hold, of the currently executing process. Typically, the current process is interrupted so that some other work can be performed. An interrupt is usually defined as an event that alters the sequence of instructions executed by a processor. Such events correspond to signals generated by software and/or hardware. For example, most Input/Output (I/O) devices generate an interrupt in order to transmit or receive data. Software programs can also generate interrupts to initiate I/O as needed, request OS services, or handle unexpected conditions.

Handling interrupts is a sensitive task. Interrupts can occur at any time, the kernel tries to get the interrupt addressed as soon as possible. Additionally, an interrupt can be interrupted by another interrupt.

20.1 Multi-user Operating System

A modern multi-user Operating System (OS) supports multiple programs executing, or appearing to be executing, simultaneously by sharing resources as necessary. The OS is responsible for managing and sharing the resources. These resources include the CPU cores, primary memory (i.e., RAM), secondary storage (i.e., disk or SSD), display screen, keyboard, and mouse. For example, multiple programs must share the available CPU resources (core or cores as applicable).

The interrupt mechanism is the primary means that the OS uses in order to provide the resource sharing. Consequently, understanding how interrupts are processed by the

⁶⁴ For more information, refer to: <http://en.wikipedia.org/wiki/Interrupt>

computer provides insight into how the operating system is able to provide multi-processing functions. When an interrupt occurs, the current process is interrupted (i.e., placed on hold), the interrupt is handled (which depends on the specific reason for the interrupt), and then eventually the process is resumed. The OS may choose to perform other tasks or processes before the original process is resumed. The interrupt is handled by a special software routine called an Interrupt Service Routine (also called Interrupt Handler, Device Driver, etc.). By using interrupts and quickly switching between various processes, the OS is able to provide the illusion that all processes are executing simultaneously.

Not all code can be interrupted. For example, due to the nature of some operating system kernel functions, there are regions in the kernel which must not be interrupted at all. This includes updating some sensitive operating system data structures.

20.1.1 Interrupt Classification

To better understand interrupts and interrupt processing, some background on the timing and categories of interrupts is useful.

20.1.2 Interrupt Timing

The timing of interrupts may occur synchronously or asynchronously. These terms are fairly common terms in computer processing and are explained in the following sections.

20.1.2.1 Asynchronous Interrupts

In the context of computer interrupts, an asynchronously occurring interrupt means that the interrupt may occur at an arbitrary time with respect to program execution. Asynchronous interrupts are unpredictable relative to any specific location within the executing process. For example, an external hardware device might interrupt the currently executing process at an unpredictable location.

20.1.2.2 Synchronous Interrupts

Synchronously occurring interrupts typically occur while under CPU control and are caused by or on behalf of the currently executing process. The synchronous nature is related to where the interrupt occurs and not a specific clock time or CPU cycle time. Synchronous interrupts typically reoccur at the same location (assuming nothing has changed to resolve the original cause).

20.1.3 Interrupt Categories

Interrupts are typically categorized as hardware or software.

20.1.3.1 Hardware Interrupt

Hardware interrupts are typically generated by hardware. Hardware interrupts can be issued by

- I/O devices (keyboard, network adapter, etc.)
- Interval timers
- Other CPUs (on multiprocessor systems)

Hardware interrupts are asynchronously occurring. An example of a hardware interrupt is when a key is typed on the keyboard. The OS cannot know ahead of time when, or even if, the key will be pressed. To handle this situation, the keyboard support hardware will generate an interrupt. If the OS is executing an unrelated program, that program is temporarily interrupted while the key is processed. In this example, that specific processing consists of storing the key in a buffer and returning to the interrupted process. Ideally, this brief interruption will have little impact in the interrupted process.

20.1.3.1.1 Exceptions

An exception is a term for an interrupt that is caused by the current process and needs attention of the kernel. Exceptions are synchronously occurring. In this context, synchronous implies that the exception will occur in a predictable or repeatable manner.

Exceptions are typically divided into categories as follows:

- Faults
- Traps
- Abort

An example of a fault is a page fault which is a request for loading part of the program from disk storage into memory. The interrupted process restarts with no loss of continuity.

A trap is typically used for debugging. The process re-starts with no loss of continuity.

An abort is typically an indication that a serious error condition occurred and must be handled. This includes division by zero, attempt to access an invalid memory address, or attempt to execute an invalid/illegal instruction. An illegal instruction might be an instruction that is only allowed to be executed by privileged/authorized processes. An

invalid instruction might be caused by attempting to execute a data item (which will not make sense). Based on the severity of the error condition, the process is often terminated. If the process is not terminated, another routine may be executed to attempt to resolve the problem and re-execute the original routine (but not necessarily from the interrupted location). The C/C++/Java try/catch block is an example of this.

It must be noted that there is not an absolute agreed upon definition for these terms. Some texts use slightly different terminology.

20.1.3.2 Software Interrupts

A software interrupt is produced by the CPU while processing instructions. This is typically a programmed exception explicitly requested by the programmer. Such interrupts are typically synchronously occurring and often used to request system services from the OS. For example, requesting system services such as I/O.

20.2 Interrupt Types and Levels

Interrupts have various types and privileges associated with them. The following sections provide an explanation of the types and privileges. Interrupted processes may execute at a lower privilege than the interrupt processing code. In order for interrupts to be effective, the OS must securely handle this privilege escalation and deescalation securely and quickly.

20.2.1 Interrupt Types

The two different types or kinds of interrupts are:

- Maskable interrupts
- Non-maskable interrupts

Maskable interrupts are typically issued by I/O devices. As the name 'maskable' implies, maskable interrupts can be ignored, or masked, for a short time period. This allows the associated interrupt processing to be delayed.

Non-maskable interrupts (NMI's) must be handled immediately. This includes some OS functions and critical malfunctions such as hardware failures. Non-maskable interrupts are always processed by the CPU.

20.2.2 Privilege Levels

Privilege Levels refer to the privilege level at which the interrupt code executes. This may be a higher privilege level than the interrupted code is executing. The processor

executes code in one of four privilege levels as follows:

| Level | Description |
|----------------|---|
| Level 0 | Full access to all hardware resources (no restrictions). Used by only the lowest level OS functions. |
| Level 1 | Somewhat restricted access to hardware resources. Used by library routines and software that interacts with hardware. |
| Level 2 | More restricted access to hardware resources. Used by library routines and software that has limited access to some hardware. |
| Level 3 | No direct access to hardware resources. Application programs run at this level. |

Should an application program executing at level 3 be interrupted by a hardware interrupt for the keyboard, the keyboard interrupt handler must execute at level 0.

The following diagram shows the relationship of the levels.

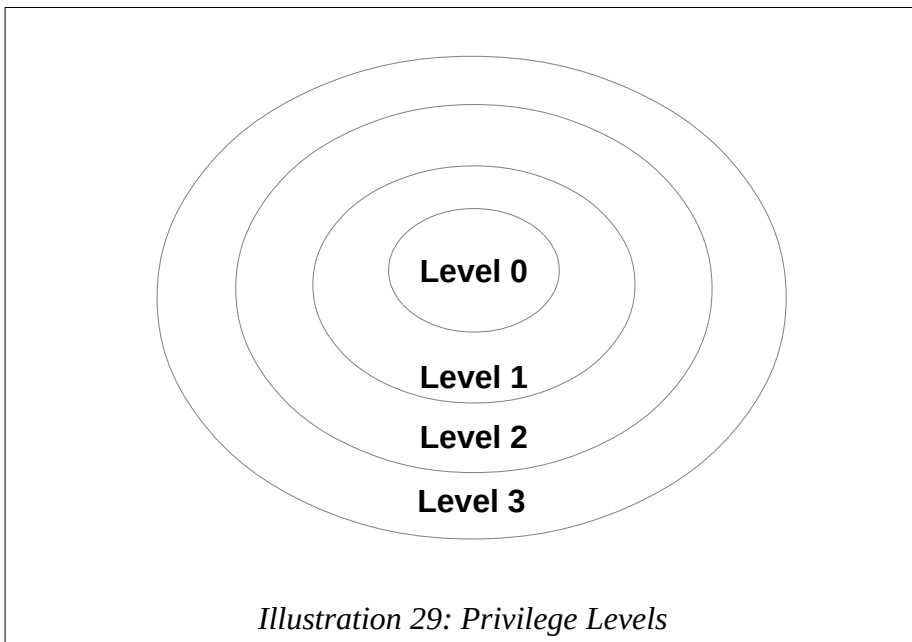

The operating system interrupt processing mechanism will handle this privilege

elevation and restoration in a secure manner. That requires that the interrupt source and privileges be verified as part of the interrupt handling mechanism.

20.3 Interrupt Processing

When an interrupt occurs, it must be handled or processed securely, quickly, and correctly. The general idea is that when the currently executing process is interrupted it must be placed on hold, and the appropriate interrupt handling code found and executed. The specific interrupt processing required depends on the cause or purpose of the interrupt. Once the interrupt is serviced, the original process execution will eventually be resumed.

20.3.1 Interrupt Service Routine (ISR)

The code that is executed in response to an interrupt is typically called an Interrupt Service Routine or ISR. The code is sometimes referred to as interrupt handler, handler, service routine, or TSR code. For consistency, this document will use the term ISR.

ISR code is challenging to develop due to the issues related to the concurrency and race conditions. Additionally, it is difficult to isolate problems and debug ISR code.

20.3.2 Processing Steps

The general steps involved in processing an interrupt are outlined in the following sections.

20.3.2.1 Suspension

The execution of current program is suspended. As a minimum, this requires saving the **rip** and **rFlags** registers to system stack. The remaining registers are likely to be preserved (as a further step), depending on the specific interrupt. The **rFlags** flag register must be preserved immediately since the interrupt may have been generated asynchronously and those registers will change as successive instructions are executed. This multi-stage process ensures that the program context can be fully restored.

20.3.2.2 Obtaining ISR Address

The ISR addresses are stored in a table referred to as an Interrupt Descriptor Table⁶⁵ (IDT). For each ISR, the IDT contains the ISR address and some additional information including task gate (priority and privilege information) for the ISR. Each entry in the IDT is a total of 8 bytes each for a total of 16 bytes per IST entry. There are a maximum

⁶⁵ *Note*, for Windows this data structure is referred to as the Interrupt Vector Table (IVT).

of 256 (0-255) possible entries in the IDT.

To obtain the starting address of an ISR, the interrupt number is multiplied by 16 (since each entry is 16 bytes) which is used as offset into the IDT where the ISR address is obtained (for that interrupt).

The start of the IDT is pointed to by a dedicated register, IDTR, which is only accessible by the OS and requires level 0 privilege to access.

The addresses of the ISR routines are specific to the OS version and the specific hardware complement of the system. The IDT is created when the system initially boots and reflects the specific system configuration. This is critical in order for the OS to work correctly and consistently on different system hardware configurations.

20.3.2.3 Jump to ISR

Once the ISR address is obtained from the IDT some validation is performed. This includes ensuring the interrupt is from a legal/valid source and if a privilege level change is required and allowed. Once the verifications have been completed successfully, the address of the ISR from the IDT is placed in the **rip** register, thus effecting a jump to the ISR routine.

20.3.2.4 Suspension Execute ISR

At this point, depending on the specific ISR, a complete process context switch may be performed. A process context switch involves saving the entire set of CPU registers for the interrupted process.

In Linux-based OS's, ISR are typically divided into two parts, referred to as the top-half and bottom-half. Other OS's refer to these as the First-Level Interrupt Handler (FLIH) and the Second-Level Interrupt Handlers (SLIH).

The top-half or FLIH is executed immediately and is where any critical activities are performed. The activities are specific to the ISR, but might include acknowledging the interrupt, resetting hardware (if necessary), and recording any information only available at the time of interrupt. The top-half may perform some blocking of other interrupts (which needs to be minimized).

The bottom-half is where any processing activities (if any) are performed. This helps ensure that the top-half is completed quickly and that any non-critical processing is deferred to a more convenient time. If a bottom-half exists, the top-half will create and schedule the execution of the bottom-half.

Once the top-half completes, the OS scheduler will select a new process.

20.3.2.5 Resumption

When the OS is ready to resume the interrupted process, the program context is restored and an **iret** instruction is executed (to pop **rFlags** and **rip** registers, thus completing the restoration).

20.4 Suspension Interrupt Processing Summary

The following diagram presents an overview of the general flow used for processing interrupts by the system.

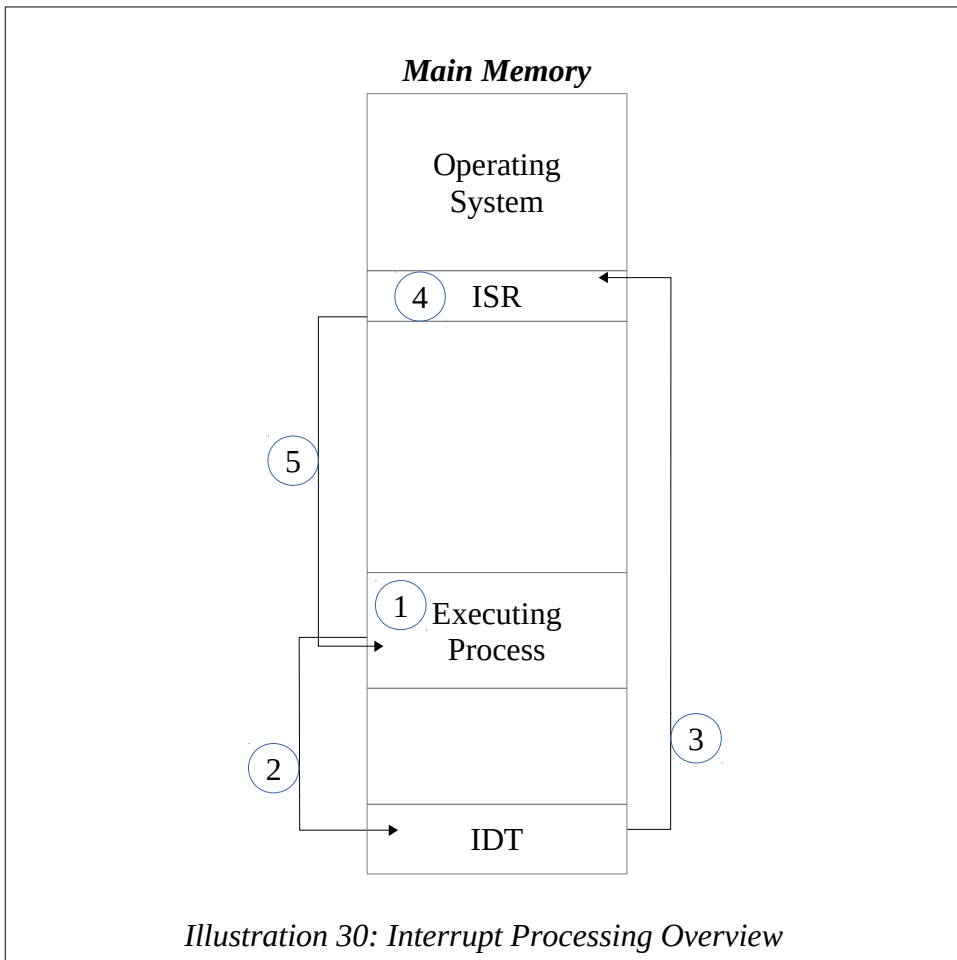

The steps are details as follows:

1. Execution of current program is suspended
 - save **rip** and **rFlags** registers to stack
2. Obtain starting address of Interrupt Service Routine (ISR)
 - interrupt number multiplied by 16
 - used as offset into Interrupt Descriptor Table (IDT)
 - obtains ISR address (for that interrupt) from IDT
3. Jump to Interrupt Service Routine
 - set **rip** to address from IDT
4. Interrupt Service Routine Executes
 - save context (i.e., any additional registers altered)
 - process interrupt (specific to interrupt generated)
 - schedule any later data processing activities
5. Interrupted Process Resumption
 - resume scheduling based on OS scheduler
 - restore context
 - perform **iret** (to pop **rFlags** and **rip** registers)

This interrupt processing mechanism allows a dynamic, run-time lookup for the ISR address.

20.5 Exercises

Below are some quiz questions and suggested projects based on this chapter.

20.5.1 Quiz Questions

Below are some quiz questions based on this chapter.

- 1) What is the operating system responsible for? Name some of the resources.
- 2) What is an interrupt?
- 3) What is an exception?

- 4) What is an ISR and what is it for?
- 5) Where (name of the data structure) does the operating system obtain the address when an interrupt occurs and what is contained in it?
- 6) When an interrupt occurs, how the appropriate offset into the IDT calculated?
- 7) What is the difference between the **iret** and **ret** instructions?
- 8) Why does the OS use the interrupt mechanism instead of just performing a standard call.
- 9) What is meant by asynchronously occurring interrupts?
- 10) What is meant by synchronously occurring interrupts?
- 11) When an interrupt occurs, the **rip** and **rFlags** registers are pushed on the stack. Much like the call statement, the **rip** register is pushed to save the return address. Explain why is the **rFlag** register pushed on the stack.
- 12) Name two hardware interrupts.
- 13) List one way for a program to generate an exception.
- 14) What is the difference between a maskable and non-maskable interrupt?

20.5.2 Suggested Projects

Below are some suggested projects based on this chapter.

- 1) Write a program to obtain and list the contents of the IDT. This will require an integer to ASCII/Hex program in order to display the applicable addresses in hex. Use the debugger as necessary to debug the program. When working, execute the program without the debugger to displayed results.

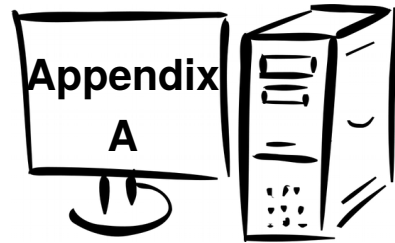

21.0 Appendix A – ASCII Table

This appendix provides a copy of the ASCII Table for reference.

| Char | Dec | Hex |
|------|-----|------|
| NUL | 0 | 0x00 |
| SOH | 1 | 0x01 |
| STX | 2 | 0x02 |
| ETX | 3 | 0x03 |
| EOT | 4 | 0x04 |
| ENQ | 5 | 0x05 |
| ACK | 6 | 0x06 |
| BEL | 7 | 0x07 |
| BS | 8 | 0x08 |
| TAB | 9 | 0x09 |
| LF | 10 | 0x0A |
| VT | 11 | 0x0B |
| FF | 12 | 0x0C |
| CR | 13 | 0x0D |
| SO | 14 | 0x0E |
| SI | 15 | 0x0F |
| DLE | 16 | 0x10 |
| DC1 | 17 | 0x11 |
| DC2 | 18 | 0x12 |
| DC3 | 19 | 0x13 |

| Char | Dec | Hex |
|------|-----|------|
| spc | 32 | 0x20 |
| ! | 33 | 0x21 |
| " | 34 | 0x22 |
| # | 35 | 0x23 |
| \$ | 36 | 0x24 |
| % | 37 | 0x25 |
| & | 38 | 0x26 |
| ' | 39 | 0x27 |
| (| 40 | 0x28 |
|) | 41 | 0x29 |
| * | 42 | 0x2A |
| + | 43 | 0x2B |
| , | 44 | 0x2C |
| - | 45 | 0x2D |
| . | 46 | 0x2E |
| / | 47 | 0x2F |
| 0 | 48 | 0x30 |
| 1 | 49 | 0x31 |
| 2 | 50 | 0x32 |
| 3 | 51 | 0x33 |

| Char | Dec | Hex |
|------|-----|------|
| @ | 64 | 0x40 |
| A | 65 | 0x41 |
| B | 66 | 0x42 |
| C | 67 | 0x43 |
| D | 68 | 0x44 |
| E | 69 | 0x45 |
| F | 70 | 0x46 |
| G | 71 | 0x47 |
| H | 72 | 0x48 |
| I | 73 | 0x49 |
| J | 74 | 0x4A |
| K | 75 | 0x4B |
| L | 76 | 0x4C |
| M | 77 | 0x4D |
| N | 78 | 0x4E |
| O | 79 | 0x4F |
| P | 80 | 0x50 |
| Q | 81 | 0x51 |
| R | 82 | 0x52 |
| S | 83 | 0x53 |

| Char | Dec | Hex |
|------|-----|------|
| ` | 96 | 0x60 |
| a | 97 | 0x61 |
| b | 98 | 0x62 |
| c | 99 | 0x63 |
| d | 100 | 0x64 |
| e | 101 | 0x65 |
| f | 102 | 0x66 |
| g | 103 | 0x67 |
| h | 104 | 0x68 |
| i | 105 | 0x69 |
| j | 106 | 0x6A |
| k | 107 | 0x6B |
| l | 108 | 0x6C |
| m | 109 | 0x6D |
| n | 110 | 0x6E |
| o | 111 | 0x6F |
| p | 112 | 0x70 |
| q | 113 | 0x71 |
| r | 114 | 0x72 |
| s | 115 | 0x73 |

Appendix A – ASCII Table

| | | |
|------------|-----------|-------------|
| DC4 | 20 | 0x14 |
| NAK | 21 | 0x15 |
| SYN | 22 | 0x16 |
| ETB | 23 | 0x17 |
| CAN | 24 | 0x18 |
| EM | 25 | 0x19 |
| SUB | 26 | 0x1A |
| ESC | 27 | 0x1B |
| FS | 28 | 0x1C |
| GS | 29 | 0x1D |
| RS | 30 | 0x1E |
| US | 31 | 0x1F |

| | | |
|-------------|-----------|-------------|
| 4 | 52 | 0x34 |
| 5 | 53 | 0x35 |
| 6 | 54 | 0x36 |
| 7 | 55 | 0x37 |
| 8 | 56 | 0x38 |
| 9 | 57 | 0x39 |
| : | 58 | 0x3A |
| ; | 59 | 0x3B |
| < | 60 | 0x3C |
| = | 61 | 0x3D |
| > | 62 | 0x3E |
| ? | 63 | 0x3F |

| | | |
|----------|-----------|-------------|
| T | 84 | 0x54 |
| U | 85 | 0x55 |
| V | 86 | 0x56 |
| W | 87 | 0x57 |
| X | 88 | 0x58 |
| Y | 89 | 0x59 |
| Z | 90 | 0x5A |
| [| 91 | 0x5B |
| \ | 92 | 0x5C |
|] | 93 | 0x5D |
| ^ | 94 | 0x5E |
| _ | 95 | 0x5F |

| | | |
|------------|------------|-------------|
| t | 116 | 0x74 |
| u | 117 | 0x75 |
| v | 118 | 0x76 |
| w | 119 | 0x77 |
| x | 120 | 0x78 |
| y | 121 | 0x79 |
| z | 122 | 0x7A |
| { | 123 | 0x7B |
| | 124 | 0x7C |
| } | 125 | 0x7D |
| ~ | 126 | 0x7E |
| DEL | 127 | 0x7F |

For additional information and a more complete listing of the ASCII codes (including the extended ASCII characters), refer to <http://www.asciitable.com/>

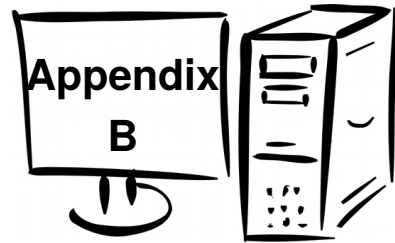

22.0 Appendix B – Instruction Set Summary

This appendix provides a listing and brief description of the instructions covered in this text. This set of instructions is a subset of the complete instruction set. For a complete listing of the instructions, refer to the references noted in chapter 1.

22.1 Notation

The following table summarizes the notational conventions used.

| Operand Notation | Description |
|---|--|
| <reg> | Register operand. The operand must be a register. |
| <reg8> , <reg16> , <reg32> , <reg64> | Register operand with specific size requirement. For example, reg8 means a byte sized register (e.g., al , bl , etc.) only and reg32 means a double-word sized register (e.g., eax , ebx , etc.) only. |
| <dest> | Destination operand. The operand may be a register or memory. Since it is a destination operand, the contents will be overwritten with the new result (based on the specific instruction). |
| <RXdest> | Floating-point destination register operand. The operand must be a floating-point register. Since it is a destination operand, the contents will be overwritten with the new result (based on the specific instruction). |
| <src> | Source operand. Operand value is unchanged after the instruction. |
| <imm> | Immediate value. May be specified in decimal, hex, octal, or binary. |

Appendix B – Instruction Set Summary

| Operand Notation | Description |
|--|---|
| <mem> | Memory location. May be a variable name or an indirect reference (i.e., a memory address). |
| <op> or <operand> | Operand, register or memory. |
| <op8>, <op16>, <op32>, <op64> | Operand, register or memory, with specific size requirement. For example, op8 means a byte sized operand only and reg32 means a double-word sized operand only. |
| <label> | Program label. |

22.2 Data Movement Instructions

Below is a summary of the basic data movement and addressing instructions.

| Instruction | Explanation |
|---------------------------------------|--|
| mov <dest>, <src> | Copy source operand to the destination operand. <i>Note 1</i> , both operands cannot be memory. <i>Note 2</i> , destination operands cannot be an immediate. |
| lea <reg64>, <mem> | Place address of <mem> into reg64 . |

22.3 Data Conversion instructions

Below is a summary of the basic data conversion instructions.

| Instruction | Explanation |
|--|---|
| movzx <dest>, <src> | Unsigned widening conversion. |
| movzx <reg16>, <op8> | <i>Note 1</i> , both operands cannot be memory. |
| movzx <reg32>, <op8> | <i>Note 2</i> , destination operands cannot be an immediate. |
| movzx <reg32>, <op16> | <i>Note 3</i> , immediate values not allowed. |
| movzx <reg64>, <op8> | |
| movzx <reg64>, <op16> | |
| cbw | Convert byte in al into word in ax . <i>Note</i> , only works for al to ax register. |

| Instruction | Explanation |
|--|--|
| cwd | Convert word in ax into double-word in dx:ax . <i>Note</i> , only works for ax to dx:ax registers. |
| cwde | Convert word in ax into double-word in eax . <i>Note</i> , only works for ax to eax register. |
| cdq | Convert double-word in eax into quadword in edx:eax . <i>Note</i> , only works for eax to edx:eax registers. |
| cdqe | Convert double-word in eax into quadword in rax . <i>Note</i> , only works for rax register. |
| cqo | Convert quadword in rax into word in double-quadword in rdx:rax . <i>Note</i> , only works for rax to rdx:rax registers. |
| movsx <dest>, <src> movsx <reg16>, <op8> movsx <reg32>, <op8> movsx <reg32>, <op16> movsx <reg64>, <op8> movsx <reg64>, <op16> movsxd <reg64>, <op32> | Signed widening conversion (via sign extension). <i>Note 1</i> , both operands cannot be memory. <i>Note 2</i> , destination operands cannot be an immediate. <i>Note 3</i> , immediate values not allowed. |

22.4 Integer Arithmetic Instructions

Below is a summary of the basic integer arithmetic instructions.

| Instruction | Explanation |
|--------------------------|--|
| add <dest>, <src> | Add two operands, (<dest> + <src>) and place the result in <dest> (over-writing previous value). <i>Note 1</i> , both operands cannot be memory. <i>Note 2</i> , destination operand cannot be an immediate. |
| inc <operand> | Increment <operand> by 1. <i>Note</i> , <operand> cannot be an immediate. |
| adc <dest>, <src> | Add two operands, (<dest> + <src>) and any |

Appendix B – Instruction Set Summary

| Instruction | Explanation |
|--|--|
| | <p>previous carry (stored in the carry bit in the rFlag register) and place the result in <dest> (over-writing previous value).</p> <p><i>Note 1</i>, both operands cannot be memory. <i>Note 2</i>, destination operand cannot be an immediate.</p> |
| <p style="text-align: center;">Examples:</p> | <pre>adc rcx, qword [dVvar1] adc rax, 42</pre> |
| <pre>sub <dest>, <src></pre> | <p>Subtract two operands, (<dest> - <src>) and place the result in <dest> (over-writing previous value).</p> <p><i>Note 1</i>, both operands cannot be memory. <i>Note 2</i>, destination operand cannot be an immediate.</p> |
| <pre>dec <operand></pre> | <p>Decrement <operand> by 1. <i>Note</i>, <operand> cannot be an immediate.</p> |
| <pre>mul <src> mul <op8> mul <op16> mul <op32> mul <op64></pre> | <p>Multiply A register (al, ax, eax, or rax) times the <src> operand.</p> <p>Byte: ax = al * <src> Word: dx:ax = ax * <src> Double: edx:eax = eax * <src> Quad: rdx:rax = rax * <src></p> <p><i>Note</i>, <src> operand cannot be an immediate.</p> |
| <pre>imul <src> imul <dest>, <src/imm32> imul <dest>, <src>, <imm32> imul <op8> imul <op16> imul <op32> imul <op64> imul <reg16>, <op16/imm> imul <reg32>, <op32/imm> imul <reg64>, <op64/imm> imul <reg16>, <op16>, <imm> imul <reg32>, <op32>, <imm> imul <reg64>, <op64>, <imm></pre> | <p>Signed multiply instruction.</p> <p>For single operand: Byte: ax = al * <src> Word: dx:ax = ax * <src> Double: edx:eax = eax * <src> Quad: rdx:rax = rax * <src></p> <p><i>Note</i>, <src> operand cannot be an immediate.</p> <p>For two operands: <reg16> = <reg16> * <op16/imm> <reg32> = <reg32> * <op32/imm> <reg64> = <reg64> * <op64/imm></p> |

| Instruction | Explanation |
|---|--|
| | For three operands: $\langle \text{reg16} \rangle = \langle \text{op16} \rangle * \langle \text{imm} \rangle$ $\langle \text{reg32} \rangle = \langle \text{op32} \rangle * \langle \text{imm} \rangle$ $\langle \text{reg64} \rangle = \langle \text{op64} \rangle * \langle \text{imm} \rangle$ |
| div $\langle \text{src} \rangle$ div $\langle \text{op8} \rangle$ div $\langle \text{op16} \rangle$ div $\langle \text{op32} \rangle$ div $\langle \text{op64} \rangle$ | Unsigned divide A/D register (ax , dx:ax , edx:eax , or rdx:rax) by the $\langle \text{src} \rangle$ operand. Byte: al = ax / $\langle \text{src} \rangle$, rem in ah Word: ax = dx:ax / $\langle \text{src} \rangle$, rem in dx Double: eax = eax / $\langle \text{src} \rangle$, rem in edx Quad: rax = rax / $\langle \text{src} \rangle$, rem in rdx <i>Note</i> , $\langle \text{src} \rangle$ operand cannot be an immediate. |
| idiv $\langle \text{src} \rangle$ idiv $\langle \text{op8} \rangle$ idiv $\langle \text{op16} \rangle$ idiv $\langle \text{op32} \rangle$ idiv $\langle \text{op64} \rangle$ | Signed divide A/D register (ax , dx:ax , edx:eax , or rdx:rax) by the $\langle \text{src} \rangle$ operand. Byte: al = ax / $\langle \text{src} \rangle$, rem in ah Word: ax = dx:ax / $\langle \text{src} \rangle$, rem in dx Double: eax = eax / $\langle \text{src} \rangle$, rem in edx Quad: rax = rax / $\langle \text{src} \rangle$, rem in rdx <i>Note</i> , $\langle \text{src} \rangle$ operand cannot be an immediate. |

22.5 Logical, Shift, and Rotate Instructions

Below is a summary of the basic logical, shift, arithmetic shift, and rotate instructions.

| Instruction | Explanation |
|--|--|
| and $\langle \text{dest} \rangle, \langle \text{src} \rangle$ | Perform logical AND operation on two operands, ($\langle \text{dest} \rangle$ and $\langle \text{src} \rangle$) and place the result in $\langle \text{dest} \rangle$ (over-writing previous value). <i>Note 1</i> , both operands cannot be memory. <i>Note 2</i> , destination operand cannot be an immediate. |
| or $\langle \text{dest} \rangle, \langle \text{src} \rangle$ | Perform logical OR operation on two operands, ($\langle \text{dest} \rangle$ $\langle \text{src} \rangle$) and place the result in $\langle \text{dest} \rangle$ (over-writing previous value). <i>Note 1</i> , both operands cannot be memory. <i>Note 2</i> , destination operand cannot be an immediate. |

Appendix B – Instruction Set Summary

| Instruction | Explanation |
|---|---|
| xor <dest>, <src> | Perform logical XOR operation on two operands, (<dest> ^ <src>) and place the result in <dest> (over-writing previous value). <i>Note 1</i> , both operands cannot be memory. <i>Note 2</i> , destination operand ca not be an immediate. |
| not <op> | Perform a logical not operation (one's complement on the operand 1's → 0's and 0's → 1's). <i>Note</i> , operand cannot be an immediate. |
| shl <dest>, <imm> shl <dest>, cl | Perform logical shift left operation on destination operand. Zero fills from left (as needed). The <imm> or the value in cl register must be between 1 and 64. <i>Note</i> , destination operand cannot be an immediate. |
| shr <dest>, <imm> shr <dest>, cl | Perform logical shift right operation on destination operand. Zero fills from right (as needed). The <imm> or the value in cl register must be between 1 and 64. <i>Note</i> , destination operand cannot be an immediate. |
| sal <dest>, <imm> sal <dest>, cl | Perform arithmetic shift left operation on destination operand. Zero fills from left (as needed). The <imm> or the value in cl register must be between 1 and 64. <i>Note</i> , destination operand cannot be an immediate. |
| sar <dest>, <imm> sar <dest>, cl | Perform arithmetic shift right operation on destination operand. Sign fills from right (as needed). The <imm> or the value in cl register must be between 1 and 64. <i>Note</i> , destination operand cannot be an immediate. |

| Instruction | Explanation |
|--|---|
| rol <dest>, <imm> rol <dest>, cl | Perform rotate left operation on destination operand. The <imm> or the value in cl register must be between 1 and 64. <i>Note</i> , destination operand cannot be an immediate. |
| ror <dest>, <imm> ror <dest>, cl | Perform rotate right operation on destination operand. The <imm> or the value in cl register must be between 1 and 64. <i>Note</i> , destination operand cannot be an immediate. |

22.6 Control Instructions

Below is a summary of the basic control instructions.

| Instruction | Explanation |
|-------------------------|--|
| cmp <op1>, <op2> | Compare <op1> with <op2>. Results are stored in the rFlag register. <i>Note 1</i> , operands are not changed. <i>Note 2</i> , both operands cannot be memory. <i>Note 3</i> , <op1> operand cannot be an immediate. |
| je <label> | Based on preceding comparison instruction, jump to <label> if <op1> == <op2>. Label must be defined exactly once. |
| jne <label> | Based on preceding comparison instruction, jump to <label> if <op1> != <op2>. Label must be defined exactly once. |
| jlt <label> | For signed data, based on preceding comparison instruction, jump to <label> if <op1> < <op2>. Label must be defined exactly once. |
| jle <label> | For signed data, based on preceding comparison instruction, jump to <label> if |

Appendix B – Instruction Set Summary

| Instruction | Explanation |
|----------------------------------|---|
| | <p><op1> ≤ <op2>. Label must be defined exactly once.</p> |
| <p>jg <label></p> | <p>For signed data, based on preceding comparison instruction, jump to <label> if <op1> < <op2>. Label must be defined exactly once.</p> |
| <p>jge <label></p> | <p>For signed data, based on preceding comparison instruction, jump to <label> if <op1> ≥ <op2>. Label must be defined exactly once.</p> |
| <p>jb <label></p> | <p>For unsigned data, based on preceding comparison instruction, jump to <label> if <op1> < <op2>. Label must be defined exactly once.</p> |
| <p>jbe <label></p> | <p>For unsigned data, based on preceding comparison instruction, jump to <label> if <op1> ≤ <op2>. Label must be defined exactly once.</p> |
| <p>ja <label></p> | <p>For unsigned data, based on preceding comparison instruction, jump to <label> if <op1> < <op2>. Label must be defined exactly once.</p> |
| <p>jae <label></p> | <p>For unsigned data, based on preceding comparison instruction, jump to <label> if <op1> ≥ <op2>. Label must be defined exactly once.</p> |
| <p>loop <label></p> | <p>Decrement rcx register and jump to <label> if rcx is ≠ 0. <i>Note</i>, label must be defined exactly once.</p> |

22.7 Stack Instructions

Below is a summary of the basic stack instructions.

| Instruction | Explanation |
|--------------------|--|
| push <op64> | Push the 64-bit operand on the stack. Adjusts rsp accordingly. Operand is unaltered. |
| pop <op64> | Pop the 64-bit operand from the stack. Adjusts rsp accordingly. The operand may not be an immediate value. Operand is over-written. |

22.8 Function Instructions

Below is a summary of the basic instructions for implementing function calls.

| Instruction | Explanation |
|------------------------|--|
| call <funcName> | Calls a function. Push the 64-bit rip register and jump to the <funcName>. |
| ret | Return from a function. Pop the stack into the rip register, effecting a jump to the line after the call. |

22.9 Floating-Point Data Movement Instructions

Below is a summary of the basic instructions for floating-point data movement instructions.

| Instruction | Explanation |
|----------------------------|--|
| movss <dest>, <src> | Copy 32-bit source operand to the 32-bit destination operand. <i>Note 1</i> , both operands cannot be memory. <i>Note 2</i> , operands cannot be an immediate. |
| Examples: | movss xmm0, dword [x] movss dword [fltVar], xmm1 movss xmm3, xmm2 |

Appendix B – Instruction Set Summary

| Instruction | Explanation |
|---|--|
| movsd <dest>, <src> | Copy 64-bit source operand to the 64-bit destination operand. <i>Note 1</i> , both operands cannot be memory. <i>Note 2</i> , operands cannot be an immediate. |
| Examples: | movsd xmm0, qword [y] movsd qword [fltDVar], xmm1 movsd xmm3, xmm2 |

22.10 Floating-Point Data Conversion Instructions

Below is a summary of the basic instructions for floating-point data conversion instructions.

| Instruction | Explanation |
|--|--|
| cvtss2sd <RXdest>, <src> | Convert 32-bit floating-point source operand to the 64-bit floating-point destination operand. <i>Note 1</i> , destination operand must be floating-point register. <i>Note 2</i> , source operand cannot be an immediate. |
| Examples: | cvtss2sd xmm0, dword [fltSVar] cvtss2sd xmm3, eax cvtss2sd xmm3, xmm2 |
| cvtSD2SS <RXdest>, <src> | Convert 64-bit floating-point source operand to the 32-bit floating-point destination operand. <i>Note 1</i> , destination operand must be floating-point register. <i>Note 2</i> , source operand cannot be an immediate. |
| Examples: | cvtSD2SS xmm0, qword [fltDVar] cvtSD2SS xmm1, rax cvtSD2SS xmm3, xmm2 |

Appendix B – Instruction Set Summary

| Instruction | Explanation |
|---------------------------------|---|
| cvtss2si <reg>, <src> | Convert 32-bit floating-point source operand to the 32-bit integer destination operand. <i>Note 1</i> , destination operand must be register. <i>Note 2</i> , source operand cannot be an immediate. |
| Examples: | cvtss2si xmm1, xmm0 cvtss2si eax, xmm0 cvtss2si eax, dword [fltSVar] |
| cvtsd2si <reg>, <src> | Convert 64-bit floating-point source operand to the 32-bit integer destination operand. <i>Note 1</i> , destination operand must be register. <i>Note 2</i> , source operand cannot be an immediate. |
| Examples: | cvtss2si xmm1, xmm0 cvtss2si eax, xmm0 cvtss2si eax, qword [fltDVar] |
| cvtsi2ss <RXdest>, <src> | Convert 32-bit integer source operand to the 32-bit floating-point destination operand. <i>Note 1</i> , destination operand must be floating-point register. <i>Note 2</i> , source operand cannot be an immediate. |
| Examples: | cvtsi2ss xmm0, eax cvtsi2ss xmm0, dword [fltDVar] |
| cvtsi2sd <RXdest>, <src> | Convert 32-bit integer source operand to the 64-bit floating-point destination operand. <i>Note 1</i> , destination operand must be floating-point register. <i>Note 2</i> , source operand cannot be an immediate. |
| Examples: | cvtsi2sd xmm0, eax cvtsi2sd xmm0, dword [fltDVar] |

22.11 Floating-Point Arithmetic Instructions

Below is a summary of the basic instructions for floating-point arithmetic instructions.

| Instruction | Explanation |
|---|---|
| addss <RXdest>, <src> | Add two 32-bit floating-point operands, (<RXdest> + <src>) and place the result in <RXdest> (over-writing previous value). <i>Note 1</i> , destination operands must be a floating-point register. <i>Note 2</i> , source operand cannot be an immediate. |
| Examples: | addss xmm0, xmm3 addss xmm5, dword [fSVar] |
| addsd <RXdest>, <src> | Add two 64-bit floating-point operands, (<RXdest> + <src>) and place the result in <RXdest> (over-writing previous value). <i>Note 1</i> , destination operands must be a floating-point register. <i>Note 2</i> , source operand cannot be an immediate. |
| Examples: | addsd xmm0, xmm3 addsd xmm5, qword [fDVar] |
| subss <RXdest>, <src> | Subtract two 32-bit floating-point operands, (<RXdest> - <src>) and place the result in <RXdest> (over-writing previous value). <i>Note 1</i> , destination operands must be a floating-point register. <i>Note 2</i> , source operand cannot be an immediate. |
| Examples: | subss xmm0, xmm3 subss xmm5, dword [fSVar] |

| Instruction | Explanation |
|---|--|
| subsd <RXdest>, <src> | Subtract two 64-bit floating-point operands, (<RXdest> - <src>) and place the result in <RXdest> (over-writing previous value). <i>Note 1</i> , destination operands must be a floating-point register. <i>Note 2</i> , source operand cannot be an immediate. |
| Examples: | subsd xmm0, xmm3 subsd xmm5, qword [fDVar] |
| mulss <RXdest>, <src> | Multiply two 32-bit floating-point operands, (<RXdest> * <src>) and place the result in <RXdest> (over-writing previous value). <i>Note 1</i> , destination operands must be a floating-point register. <i>Note 2</i> , source operand cannot be an immediate. |
| Examples: | mulss xmm0, xmm3 mulss xmm5, dword [fSVar] |
| mulsd <RXdest>, <src> | Multiply two 64-bit floating-point operands, (<RXdest> * <src>) and place the result in <RXdest> (over-writing previous value). <i>Note 1</i> , destination operands must be a floating-point register. <i>Note 2</i> , source operand cannot be an immediate. |
| Examples: | mulsd xmm0, xmm3 mulsd xmm5, qword [fDVar] |
| divss <RXdest>, <src> | Divide two 32-bit floating-point operands, (<RXdest> / <src>) and place the result in <RXdest> (over-writing previous value). <i>Note 1</i> , destination operands must be a floating-point register. <i>Note 2</i> , source operand cannot be an immediate. |

Appendix B – Instruction Set Summary

| Instruction | Explanation |
|-------------------------------|--|
| Examples: | <pre>divss xmm0, xmm3 divss xmm5, dword [fSVar]</pre> |
| divsd <RXdest>, <src> | Divide two 64-bit floating-point operands, (<RXdest> / <src>) and place the result in <RXdest> (over-writing previous value). <i>Note 1</i> , destination operands must be a floating-point register. <i>Note 2</i> , source operand cannot be an immediate. |
| Examples: | <pre>divsd xmm0, xmm3 divsd xmm5, qword [fDVar]</pre> |
| sqrtd <RXdest>, <src> | Take the square root of the 32-bit floating-point source operand and place the result in destination operand (over-writing previous value). <i>Note 1</i> , destination operands must be a floating-point register. <i>Note 2</i> , source operand cannot be an immediate. |
| Examples: | <pre>sqrtd xmm0, xmm3 sqrtd xmm7, dword [fSVar]</pre> |
| sqrtsd <RXdest>, <src> | Take the square root of the 64-bit floating-point source operand and place the result in destination operand (over-writing previous value). <i>Note 1</i> , destination operands must be a floating-point register. <i>Note 2</i> , source operand cannot be an immediate. |
| Examples: | <pre>sqrtsd xmm0, xmm3 sqrtsd xmm7, qword [fDVar]</pre> |

22.12 Floating-Point Control Instructions

Below is a summary of the basic instructions for floating-point control instructions.

| Instruction | Explanation |
|--|--|
| ucomiss <RXsrc>, <src> | Compare two 32-bit floating-point operands, (<RXsrc> + <src>). Results are placed in the rFlag register. Neither operand is changed. <i>Note 1</i> , <RXsrc> operands must be a floating-point register. <i>Note 2</i> , source operand may be a floating-point register or memory, but not be an immediate. |
| Examples: | ucomiss xmm0, xmm3 ucomiss xmm5, dword [fSVar] |
| ucomisd <RXsrc>, <src> | Compare two 64-bit floating-point operands, (<RXsrc> + <src>). Results are placed in the rFlag register. Neither operand is changed. <i>Note 1</i> , <RXsrc> operands must be a floating-point register. <i>Note 2</i> , source operand may be a floating-point register or memory, but not be an immediate. |
| Examples: | ucomiss xmm0, xmm3 ucomiss xmm5, dword [fSVar] |

Appendix B – Instruction Set Summary

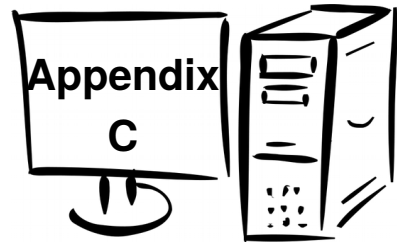

23.0 Appendix C – System Services

This appendix provides a listing and brief description of a subset of the system service calls. This list is for 64-bit Ubuntu systems. A more complete list can be obtained from multiple web sources.

23.1 Return Codes

The system call will return a code in the **rax** register. If the value returned is less than 0, that is an indication that an error has occurred. If the operation is successful, the value returned will depend on the specific system service. Refer to the Error Codes section for additional information regarding the values of the error codes.

23.2 Basic System Services

The following table summarizes the more common system services.

| Call Code (rax) | System Service | Description |
|-----------------|------------------|--|
| 0 | SYS_read | Read characters |
| | | rdi = file descriptor (of where to read from) |
| | | rsi = address of where to store characters |
| | | rdx = count of characters to read |
| | | If unsuccessful, returns negative value. If successful, returns count of characters actually read. |
| 1 | SYS_write | Write characters |
| | | rdi = file descriptor (of where to write to) |

Appendix C – System Services

| Call Code (rax) | System Service | Description |
|----------------------------|-----------------------|---|
| | | rsi = address of characters to write |
| | | rdx = count of characters to write |
| | | If unsuccessful, returns negative value. If successful, returns count of characters actually written. |
| 2 | SYS_open | Open a file |
| | | rdi = address of NULL terminated file name |
| | | rsi = file status flags (typically O_RDONLY) |
| | | If unsuccessful, returns negative value. If successful, returns file descriptor. |
| 3 | SYS_close | Close an open file |
| | | rdi = file descriptor of open file to close |
| | | If unsuccessful, returns negative value. |
| 8 | SYS_lseek | Reposition the file read/write file offset. |
| | | rdi = file descriptor (of where to write to) |
| | | rsi = offset |
| | | rdx = origin |
| | | If unsuccessful, returns negative value. |
| | | |
| 57 | SYS_fork | Fork current process. |
| 59 | SYS_execve | Execute a program |
| | | rdi = Address of NULL terminated string for name of program to execute. |
| | | |
| 60 | SYS_exit | Terminate executing process. |
| | | rdi = exit status (typically 0) |

| Call Code (rax) | System Service | Description |
|-----------------|---|---|
| 85 | SYS_creat | Open/Create a file. |
| | | rdi = address of NULL terminated file name |
| | | rsi = file mode flags |
| | If unsuccessful, returns negative value. If successful, returns file descriptor. | |
| 96 | SYS_gettimeofday | Get date and time of day |
| | | rdi = address of time value structure |
| | | rsi = address of time zone structure |
| | If unsuccessful, returns negative value. If successful, returns information in the passed structures. | |
| | | |

23.3 File Modes

When performing file operations, the file mode provides information to the operating system regarding the file access permissions that will be allowed.

When opening an existing file, one of the following file modes must be specified.

| Mode | Value | Description |
|----------|-------|--|
| O_RDONLY | 0 | Read only. Allow reading from the file, but to not allow writing to the file. Most common operation. |
| O_WRONLY | 1 | Write only. Typically used if information is to be appended to a file. |
| O_RDWR | 2 | Allow simultaneous reading and writing. |

When creating a new file, the file permissions must be specified. Below are the complete set of file permissions. As is standard for Linux file systems, the permission values are specified in Octal.

Appendix C – System Services

| Mode | Value | Description |
|---------|--------|--|
| S_IRWXU | 00700q | User (file owner) has read, write, and execute permission. |
| S_IRUSR | 00400q | User (file owner) has read permission. |
| S_IWUSR | 00200q | User (file owner) has write permission. |
| S_IXUSR | 00100q | User (file owner) has execute permission. |
| S_IRWXG | 00070q | Group has read, write, and execute permission. |
| S_IRGRP | 00040q | Group has read permission. |
| S_IWGRP | 00020q | Group has write permission. |
| S_IXGRP | 00010q | Group has execute permission. |
| S_IRWXO | 00007q | Others have read, write, and execute permission. |
| S_IROTH | 00004q | Others have read permission. |
| S_IWOTH | 00002q | Others have write permission. |
| S_IXOTH | 00001q | Others have execute permission. |

The text examples only address permissions for the user or owner of the file.

23.4 Error Codes

If a system service returns an error, the value of the return code will be negative. The following is a list of the error code. The code value is provided along with the Linux symbolic name. High-level languages typically use the name which is not used at the assembly level and is only provided for reference.

| Error Code | Symbolic Name | Description |
|------------|---------------|----------------------------|
| -1 | EPERM | Operation not permitted. |
| -2 | ENOENT | No such file or directory. |
| -3 | ESRCH | No such process. |

| | | |
|-----|---------|----------------------------|
| -4 | EINTR | Interrupted system call. |
| -5 | EIO | I/O Error. |
| -6 | ENXIO | No such device or address. |
| -7 | E2BIG | Argument list too long. |
| -8 | ENOEXEC | Exec format error. |
| -9 | EBADF | Bad file number. |
| -10 | ECHILD | No child process. |
| -11 | EAGAIN | Try again. |
| -12 | ENOMEM | Out of memory. |
| -13 | EACCES | Permission denied. |
| -14 | EFAULT | Bad address. |
| -15 | ENOTBLK | Block device required. |
| -16 | EBUSY | Device or resource busy. |
| -17 | EEXIST | File exists. |
| -18 | EXDEV | Cross-device link. |
| -19 | ENODEV | No such device. |
| -20 | ENOTDIR | Not a directory. |
| -21 | EISDIR | Is a directory. |
| -22 | EINVAL | Invalid argument. |
| -23 | ENFILE | File table overflow. |
| -24 | EMFILE | Too many open files. |
| -25 | ENOTTY | Not a typewriter. |
| -26 | ETXTBSY | Text file busy. |
| -27 | EFBIG | File too large. |
| -28 | ENOSPC | No space left on device. |
| -29 | ESPIPE | Illegal seek. |
| -30 | EROFS | Read-only file system. |
| -31 | EMLINK | Too many links. |
| -32 | EPIPE | Broken pipe. |

Appendix C – System Services

| | | |
|-----|--------|--|
| -33 | EDOM | Math argument out of domain of function. |
| -34 | ERANGE | Math result not representable. |

Only the most common error codes are shown. A complete list can be found via the Internet or by looking on the current system includes files. For Ubuntu, this is typically located in **`/usr/include/asm-generic/errno-base.h`**.

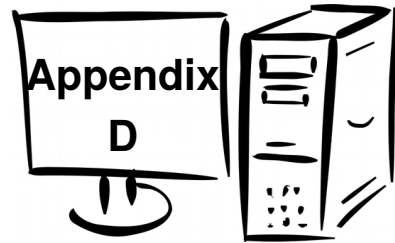

24.0 Appendix D – Quiz Question Answers

This appendix provides answers for the quiz questions in each chapter.

24.1 Quiz Question Answers, Chapter 1

There are no quiz questions for Chapter 1.

24.2 Quiz Question Answers, Chapter 2

- 1) See Section 2.1, Illustration 1, Computer Architecture.
- 2) Bus or Interconnection.
- 3) Secondary storage.
- 4) Primary storage or main memory (RAM).
- 5) Keeps a copy of the data closer to the CPU, eliminating the extra time required to access the RAM via the Bus.
- 6) 4 bytes.
- 7) 1 byte.
- 8) The LSB is 40_{16} and the MSB is 00_{16} .
- 9) The answer is as follows:

| | |
|-------------|-----------|
| High memory | 00_{16} |
| | $4C_{16}$ |
| | $4B_{16}$ |
| Low memory | 40_{16} |

Appendix D – Quiz Question Answers

10) The layout is:

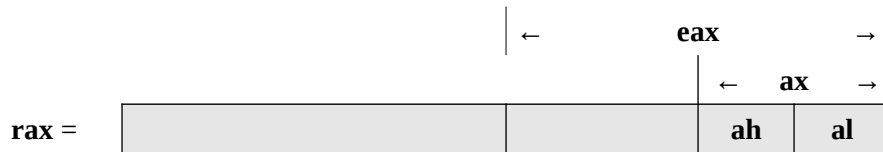

11) The answers are as follows:

1. 8
2. 64
3. 16
4. 32
5. 64
6. 8
7. 8
8. 16

12) The **rip** register.

13) The **rsp** register.

14) The **rax** register is: 0000000000000000_{16} .

15) The answers are as follows:

1. EF_{16}
2. $CDEF_{16}$
3. $89ABCDEF_{16}$
4. $0123456789ABCDEF_{16}$

24.3 Quiz Question Answers, Chapter 3

1) The answers are as follows:

1. -128 to +127
2. 0 to 255

3. -32,768 to +32,767
 4. 0 to 65,535
 5. -2,147,483,648 to +2,147,483,647
 6. 0 to 4,294,967,295
- 2) The answers are as follows:
1. 5
 2. 9
 3. 13
 4. 21
- 3) The answers are as follows:
1. 0xFD
 2. 0x0B
 3. 0xF7
 4. 0xEB
- 4) The answers are as follows:
1. 0xFFEF
 2. 0x0011
 3. 0xFFE1
 4. 0xFF76
- 5) The answers are as follows:
1. 0xFFFFFFFF5
 2. 0xFFFFFFFFE5
 3. 0x00000007
 4. 0xFFFFFFFFFB
- 6) The answers are as follows:
1. -5
 2. -22

Appendix D – Quiz Question Answers

3. -13
4. -8
- 7) 0.5_{10} is represented as 0.1_2
- 8) The answers are as follows:
 1. -12.25
 2. +12.25
 3. -6.5
 4. -7.5
- 9) The answers are as follows:
 1. 0x41340000
 2. 0xC1890000
 3. 0x41AF0000
 4. 0xBF400000
- 10) The answers are as follows:
 1. 0x41
 2. 0x61
 3. 0x30
 4. 0x38
 5. 0x09
- 11) The answers are as follows:
 1. “World” = 0x57 0x6F 0x72 0x6C 0x64
 2. “123” = 0x31 0x32 0x33
 3. “Yes!?” = 0x59 0x65 0x73 0x21 0x 3F

24.4 Quiz Question Answers, Chapter 4

- 1) yasm
- 2) With the ; (semicolon).

- 3) Section **data**.
- 4) Section **bss**.
- 5) Section **text**.
- 6) The answers are as follows:
 1. bNum db 10
 2. wNum dw 10291
 3. dwNum dd 2126010
 4. qwNum dq 10000000000
- 7) The answers are as follows:
 1. bArr resb 100
 2. wArr resw 3000
 3. dwArr resd 200
 4. qArr resq 5000
- 8) The declarations are:

```
global _start
_start:
```

24.5 Quiz Question Answers, Chapter 5

- 1) The relationship is 1:1 (one to one).
- 2) Creation of symbol table, macro expansion, and evaluation of constant expressions.
- 3) Final generation of code, create list file if requested, create object file.
- 4) Combine one or more object files into a single executable, update all relocatable addresses, search user and system libraries, create cross reference file if requested, and create final executable file.
- 5) Attempt to open executable file (verifying existence and permissions), read header information, ask operating system to create new process, if successful, read rest of executable file and load into memory (where specified by operating system), and inform operating system when load is completed. *Note*, the loader does not run the process.

Appendix D – Quiz Question Answers

6) Examples might include:

1. `BUFSIZE + 1`
2. `MAX + OFFSET`

Note, assumes that upper case implies defined constant. Many examples possible.

7) See Section 5.1, Illustration 4, Overview: Assemble, Link, Load.

8) At run-time.

9) The symbol name and the symbol address.

24.6 Quiz Question Answers, Chapter 6

1) By typing: `ddd <progName>`

2) The “-g” option.

3) Executes the program, always starting from the beginning.

4) The continue command continues to the next breakpoint.

5) Via the menu option Status → Registers.

6) The first is the register name, the second is the hex representation of the value, and the third is the decimal representation of the value (excluding some registers such as **rip** and **rsp** which are always shown in hex).

7) There are multiple ways to exit the debugger including typing **exit** in the command window, clicking the **x** (upper left corner), or using the menu options File → Exit.

8) There are multiple ways to set a breakpoint including double-clicking on the line, typing `b <lineNumber>`, or typing `b <labelName>` (if a label exists on the desired line).

9) The debugger command to read commands from a file is; `source <fileName>`.

10) The green arrow points to the next instruction to be executed.

11) The answers are as follows:

1. `x/db &bVar1`
2. `x/dh &wVar1`
3. `x/dw &dVar1`

4. x/dg &qVar1
5. x/30db &bArr1
6. x/50dh &wArr1
7. x/75dw &dArr1

12) The answers are as follows:

1. x/xb &bVar1
2. x/xh &wVar1
3. x/xw &dVar1
4. x/xg &qVar1
5. x/30xb &bArr1
6. x/50xh &wArr1
7. x/75xw &dArr1

13) The command is: x/ug \$rsp

14) The command is: x/5ug \$rsp

24.7 Quiz Question Answers, Chapter 7

1) The answers are as follows:

1. Legal
2. Legal
3. Illegal, 354 does not fit into a byte
4. Legal
5. Legal
6. Illegal, cannot change the value 54
7. Legal
8. Legal, while legal it would probably result in an incorrect value.
9. Legal
10. Legal

Appendix D – Quiz Question Answers

11. Legal, while legal it would probably result in an incorrect value.
 12. Illegal, cannot move memory to memory
 13. Illegal, cannot move memory to memory
 14. Legal
 15. Legal
 16. Legal
- 2) The answers are as follows:
1. Copies the byte value at **bVar1** into the **rsi** register treating as an unsigned value thus setting the upper 56 bits to 0.
 2. Copies the byte value at **bVar1** into the **rsi** register treating as a signed value, thus sign extending the upper 56-bits (1's for negative, 0's for positive).
- 3) The answers are as follows:
1. `mov ah, 0`
 2. `cbw`
- 4) The answers are as follows:
1. `movzx eax, ax`
 2. `cwde`
- 5) The answers are as follows:
1. `mov dx, 0`
 2. `cwd`
- 6) The **cwd** instruction only converts the signed value in **ax** into a sign value in **dx:ax** (and nothing else). The **movsx** instruction copies the word source operand into the double-word destination operand.
- 7) On the first instruction, the destination operand size can be determined from the source operand (as double-word). On the second instruction, the destination operand size must be explicitly specified since the source operand, value of 1, does not have an inherent size associated with it.
- 8) The answers are as follows (grouped in sets of 4 for clarity):
1. **rax** = 0x0000 0000 0000 0009

2. **rbx** = 0x0000 0000 0000 000B
- 9) The answers are as follows (grouped in sets of 4 for clarity):
 1. **rax** = 0x0000 0000 0000 0007
 2. **rbx** = 0x0000 0000 0000 0002
- 10) The answers are as follows (grouped in sets of 4 for clarity):
 1. **rax** = 0x0000 0000 0000 0009
 2. **rbx** = 0x0000 0000 FFFF FFF9
- 11) The answers are as follows (grouped in sets of 4 for clarity):
 1. **rax** = 0x0000 0000 0000 000C
 2. **rdx** = 0x0000 0000 0000 0000
- 12) The answers are as follows (grouped in sets of 4 for clarity):
 1. **rax** = 0x0000 0000 0000 0001
 2. **rdx** = 0x0000 0000 0000 0002
- 13) The answers are as follows (grouped in sets of 4 for clarity):
 1. **rax** = 0x0000 0000 0000 0002
 2. **rdx** = 0x0000 0000 0000 0003
- 14) The answers are as follows:
 1. The destination operand cannot be an immediate value (42).
 2. An immediate operand is not allowed since the size/type cannot be determined.
 3. The **mov** instruction does not allow a memory to memory operation.
 4. An address requires 64-bits which will not fit into the **ax** register.
- 15) The **idiv** instruction will divide by **edx:eax** and **edx** was not set.
- 16) The operands for the divide a signed (-500), but an unsigned divide is used.
- 17) The word divide used will place the result in the **dx:ax** registers, but the **eax** register is used to obtain the result.
- 18) The three-operand multiply instructions are only allowed for a limited set of signed multiplication operations.

24.8 Quiz Question Answers, Chapter 8

- 1) The first instruction places the value from qVar1 into the **rdx** register. The second instruction places the address of qVar1 into the **rdx** register.
- 2) The answers are as follows:
 1. Immediate
 2. Memory
 3. Immediate
 4. Illegal, destination operand cannot be an immediate value
 5. Register
 6. Memory
 7. Memory
 8. Illegal, source and destination operands not the same size.
- 3) The answers are as follows (grouped in sets of 4 for clarity):
 1. **eax** = 0x0000 000A
- 4) The answers are as follows (grouped in sets of 4 for clarity):
 1. **eax** = 0x0000 0003
 2. **edx** = 0x0000 0002
- 5) The answers are as follows (grouped in sets of 4 for clarity):
 1. **eax** = 0x0000 0009
 2. **ebx** = 0x0000 0002
 3. **rcx** = 0x0000 0000 0000 0000
 4. **rsi** = 0x0000 0000 0000 000C
- 6) The answers are as follows (grouped in sets of 4 for clarity):
 1. **rax** = 0x0000 0010
 2. **rcx** = 0x0000 0000 0000 0000
 3. **edx** = 0x0000 0000
 4. **rsi** = 0x0000 0000 0000 0004

7) The answers are as follows (grouped in sets of 4 for clarity):

1. **eax** = 0x0000 0002
2. **rcx** = 0x0000 0000 0000 0000
3. **edx** = 0x0000 0005
4. **rsi** = 0x0000 0000 0000 0003

8) The answers are as follows (grouped in sets of 4 for clarity):

1. **eax** = 0x0000 0018
2. **edx** = 0x0000 0000
3. **rcx** = 0x0000 0000 0000 0000
4. **rsi** = 0x0000 0000 0000 0005

24.9 Quiz Question Answers, Chapter 9

- 1) The **rsp** register.
- 2) First, **rsp = rsp - 8** and then **rax** register is copied to **[rsp]** (in that order).
- 3) 8 bytes.
- 4) The answers are as follows (grouped in sets of 4 for clarity):
 1. **r10** = 0x0000 0000 0000 0003
 2. **r11** = 0x0000 0000 0000 0002
 3. **r12** = 0x0000 0000 0000 0001
- 5) The array is reversed in memory.
- 6) Memory is used more efficiently.

24.10 Quiz Question Answers, Chapter 10

- 1) An unambiguous, ordered sequence of steps involved in solving a problem.
- 2) The answer is as follows:
 1. Understand the Problem
 2. Create the Algorithm
 3. Implement the Program

Appendix D – Quiz Question Answers

4. Test/Debug the Program
- 3) No, the steps are applicable to any language or complex problem (even beyond programming).
- 4) An assemble-time error.
- 5) An assemble-time error.
- 6) An assemble-time error.
- 7) A run-time error.

24.11 Quiz Question Answers, Chapter 11

- 1) At the top (above the data, BSS, and text sections).
- 2) Once for each time the macro is invoked.
- 3) The %% will ensure that a unique label name is generated each time the macro is used.
- 4) If the %% is omitted on a label, the label will be copied, as is, and thus appear to be duplicated.
- 5) Yes. This might be used to exit a macro to an error handling code block (not within the macro).
- 6) The macro argument substitution occurs at assemble-time.

24.12 Quiz Question Answers, Chapter 12

- 1) Linkage and Argument Transmission.
- 2) The **call** and the **ret** instructions.
- 3) Call-by-value.
- 4) Call-by-reference.
- 5) Once, regardless of how many times it is called.
- 6) The current **rip** is placed on the stack and the **rip** is changed to the address of called function.
- 7) Save and restore the contents of the callee preserved registers.
- 8) In: **rdi, rsi, rdx, rcx, r8, and r9**.
- 9) In: **edi, esi, edx, ecx, r8d, and r9d**.

- 10) That a function may change the value in the register without needing to save and restore it.
- 11) Two of: **rax**, **rcx**, **rdx**, **rsi**, **rdi**, **r8**, **r9**, **r10**, and **r11**.
- 12) Call frame, function call frame, or activation record.
- 13) A leaf function does not call other functions.
- 14) Clear the passed arguments off the stack.
- 15) Twenty-four (24) since three arguments at 8 bytes each (8 x 3).
- 16) The offset is [**rbp**+16] regardless of which saved registers are pushed.
- 17) Available memory.
- 18) Call-by-reference.
- 19) The 7th argument is at [**rbp**+16] and the 8th argument is at [**rbp**+24].
- 20) Memory efficiency since stack dynamic local variables only use memory when needed (when the function is being executed).

24.13 Quiz Question Answers, Chapter 13

- 1) The **rax** register.
- 2) The operating system.
- 3) The call code is SYS_write (1). The 1st argument in **rdi** is the output location STDOUT, the 2nd argument in **rsi** is the starting address of the characters to output, and the 3rd argument in **rdx** is the number of characters to write.
- 4) It is unknown how many characters will be entered.
- 5) The **rax** register will contain the file descriptor.
- 6) The **rax** register will contain an error code.
- 7) In: **rdi**, **rsi**, **rdx**, **r10**, **r8**, and **r9**.

24.14 Quiz Question Answers, Chapter 14

- 1) The statement is: **extern func1, func2**
- 2) The statement is: **extern func1, func2**
- 3) The assembler will generate an error.

Appendix D – Quiz Question Answers

- 4) Link-time.
- 5) The linker will generate an unsatisfied external reference error.
- 6) Yes. However, in the debugger, the code would not be displayed.

24.15 Quiz Question Answers, Chapter 15

- 1) The buffer overflow exploit is typically called *stack smashing*.
- 2) The C function does not check the array bounds of the input arguments.
- 3) Yes.
- 4) Typing a very large number of characters when input is requested and, if the program crashes.
- 5) A series of **nop** instructions designed to make the target of a buffer overflow exploit easier to hit.
- 6) Many possible answers. Delete a file, open a network connection, kill a process, etc.
- 7) Use of canaries, implementation of Data Execution Prevention (DEP), and use of Data Address Space Layout Randomization.

24.16 Quiz Question Answers, Chapter 16

- 1) The operating system. Specifically, the loader.
- 2) The program being executed.
- 3) The name of the executable file.
- 4) The **argc** refers to argument count and **argv** refers to the argument vector (starting address of the table of addresses for the string representing each argument).
- 5) In the **rdi** register.
- 6) In the **rsi** register.
- 7) The spaces are removed by the operating system so the program does not have to do anything.
- 8) No. The program is required to check and determine if that is an error.

24.17 Quiz Question Answers, Chapter 17

- 1) The end of line character for Linux is linefeed (LF) and the end of line character for Windows is carriage return, line feed (CR, LF).
- 2) Store a subset of the information for quick access.
- 3) They are in the language I/O library functions (i.e., cout, cin, etc.).
- 4) Simplify the programming.
- 5) I/O performance improvement.
- 6) The system service functions require a specific number of characters to read which is not known ahead of time for “one line” of text.
- 7) Keeps a subset of the information at the next higher level in the hierarchy (which is faster than the next lower level).
- 8) Reduces the overhead associated bus contention and memory latency for excessive system reads.
- 9) The variable values must be retained between function calls.
- 10) The end of file must be inferred from the number of characters actually read.
- 11) Many reasons possible, including file being deleted in another Window after the open or the drive (USB) being removed after the open.
- 12) The actual number of characters read will be 0 which must be checked explicitly.
- 13) To ensure the passed line buffer array is not overwritten.
- 14) By initializing the variables to indicate that all buffer characters have been read.

24.18 Quiz Question Answers, Chapter 18

- 1) The registers are: **xmm0**, **xmm1**, **xmm2**, . . . , **xmm15**.
- 2) Single precision is 32-bit and double precision is 64-bits.
- 3) Cumulative rounding error associated with the inexact representation of 0.1 in binary.
- 4) Float functions return the value in **xmm0**.
- 5) None of the floating-point registers are preserved.

24.19 Quiz Question Answers, Chapter 19

- 1) Concurrency implies multiple different (not necessarily related) processes simultaneously making progress. Parallel processing implies that processes are executing simultaneously.
- 2) Distributed computing and multiprocessing.
- 3) On different computers connected via a network.
- 4) Many possible answers, including Folding@Home and SETI@Home. An Internet search can provide a more complete listing.
- 5) On different cores in the CPU.
- 6) Distributed computing allows a very large number of compute nodes but requires communications over a network which has inherent communication delays.
- 7) Multiprocessing allows very fast communications between processes via shared memory but supports only a limited amount of simultaneous executing threads related to the number of cores available.
- 8) Multiple threads simultaneously writing to a shared variable with no control or coordination.
- 9) No. No problem exists since the variable is not being changed.
- 10) Yes. Since the variable is being changed, one thread may alter the value after the other has obtained the value.

24.20 Quiz Question Answers, Chapter 20

- 1) The operating system is responsible for managing the resources. The resources include CPU cores, primary memory, secondary storage, display screen, keyboard, and mouse.
- 2) An event that alters the sequence of instructions executed by a processor.
- 3) An interrupt that is caused by the current process and needs attention of the kernel.
- 4) An ISR is an Interrupt Service Routine which is executed when an interrupt occurs to service (perform required actions) that interrupt.
- 5) Interrupt Descriptor Table (IDT) which contains the addresses of the Interrupt Service Routines (ISRs) and the gate information.

- 6) The interrupt number is multiplied by 16.
- 7) The **ret** instruction will pop the return address from the stack and place it in the **rip** register. The **iret** instruction will pop the return address and the preserved flag register contents from the stack and place it in the **rip** register and **rFlag** registers.
- 8) The call requires the target address. Since the ISR addresses may change due to hardware changes or software updates, the interrupt mechanism performs a run-time look up for the ISR address.
- 9) That the interrupt timing, when or even if the interrupt might occur, cannot be predicted in the context of the executing code.
- 10) That the interrupt timing can be predicted in the context of the executing code. This is typical of system service calls or exceptions such as division by 0.
- 11) Each instruction changes the **rFlag** register. After the interrupt is completed, the flag register must be restored to its original value to ensure that the interrupted process is able to resume.
- 12) Many possible answers, including I/O devices such as keyboard and mouse, network adapter, secondary storage devices, or other peripherals.
- 13) Many possible answers, including dividing by 0.
- 14) A maskable interrupt may be ignored briefly where a non-maskable interrupt must be handled immediately.

Appendix D – Quiz Question Answers



25.0 Alphabetical Index

| | | | |
|--|---------|------------------------------|----------|
| 0x..... | 72 | automatics..... | 172 |
| 53..... | 290 | base address..... | 132 |
| activation record..... | 178 | Base Pointer Register..... | 12 |
| add with carry..... | 83 | Basic System Services..... | 325 |
| Addresses and Values..... | 75, 129 | biased exponent..... | 25 |
| Addressing Modes..... | 129 | BSS..... | 17 |
| American Standard Code for Information Interchange..... | 28 | BSS Section..... | 35 |
| Architecture Overview..... | 7 | buffer..... | 258 |
| argc..... | 248 | Buffering Algorithm..... | 259 |
| Argument Count..... | 249 | byte addressable..... | 15, 132 |
| Argument Transmission..... | 175 | cache memory..... | 9 |
| Argument Vector Table..... | 249 | Cache Memory..... | 14, 19 |
| argv..... | 248 | call code..... | 197 |
| Arithmetic Logic Unit..... | 9 | call frame..... | 178 |
| ASCII..... | 28 | Call Frame..... | 178 |
| Assemble and Link..... | 231 | call-by-reference..... | 175 |
| Assemble Commands..... | 43 | call-by-value..... | 175 |
| Assemble/Link Script..... | 50 | callee..... | 175 |
| Assemble/Link/Load Overview..... | 41 | Callee..... | 181, 184 |
| Assembler..... | 43 | caller..... | 175 |
| Assembler Directives..... | 47 | Caller..... | 181, 183 |
| Assembler Error..... | 161 | Calling Convention..... | 175 |
| Assembly Main..... | 228 | Calling System Services..... | 197 |
| assembly source file..... | 33 | Central Processing Unit..... | 9 |
| Asynchronous Interrupts..... | 298 | character..... | 28 |
| | | code generation..... | 47 |

Alphabetical Index

| | | | |
|---|---------|--|---------|
| Code Injection..... | 242 | Destination operand..... | 72, 309 |
| Code Injection Protections..... | 243 | Direct Memory Addressing..... | 258 |
| Code to Inject..... | 239 | Displaying Register Contents..... | 60 |
| Command Line Arguments..... | 247 | Displaying Stack Contents..... | 65 |
| Comments..... | 33 | distributed computing..... | 290 |
| Compile, Assemble, and Link..... | 234 | Distributed Computing..... | 290 |
| concurrency..... | 289 | distributed processing..... | 290 |
| Conditional Control Instructions..... | 112 | DMA..... | 258 |
| Console Input..... | 203 | dq..... | 35 |
| Console Output..... | 199 | dt..... | 35 |
| constant expression..... | 46 | dw..... | 34 |
| Conversion Instructions..... | 76 | dynamic linking..... | 50 |
| CPU register..... | 10 | Dynamic Linking..... | 50 |
| Data Address Space Layout Randomization..... | 244 | epilogue..... | 175 |
| Data Execution Prevention..... | 244 | Error Codes..... | 328 |
| Data Movement..... | 73, 266 | Error Terminology..... | 161 |
| Data representation..... | 21 | Example Program..... | 37 |
| Data Section..... | 34 | Example Program, Absolute Value..... | 285 |
| Data Stack Smashing Protector (or Canaries)..... | 244 | Example Program, List Summation.... | 133 |
| db..... | 34 | Example Program, Pyramid Areas and Volumes..... | 135 |
| dd..... | 35 | Example Program, Sum and Average. . | 283 |
| DDD Configuration Settings..... | 57 | Example, C++ Main / Assembly Function | 232 |
| DDD Debugger..... | 55 | Example, Console Input..... | 204 |
| DDD/GDB Commands Summary..... | 62 | Example, Console Output..... | 200 |
| DDD/GDB Commands, Examples..... | 64 | Example, File Read..... | 217 |
| ddq..... | 35 | Example, File Write..... | 212 |
| Debugger..... | 52 | Example, Statistical Function 1 (leaf). . | 180 |
| Debugger Command, <i>next</i> | 172 | Example, Statistical Function2 (non-leaf) | 183 |
| Debugger Command, <i>step</i> | 172 | Example, Sum and Average..... | 228 |
| Debugger Commands..... | 172 | Exceptions..... | 299 |
| Debugger Commands File (interactive). . | 65 | Executing Programs..... | 58 |
| Debugger Commands File (non- interactive)..... | 66p. | extern..... | 227 |
| Debugging Macros..... | 169 | Extern Statement..... | 227 |
| Defining Constants..... | 34 | external reference..... | 48 |
| dereferencing..... | 130 | File Control Block..... | 208 |

| | | | |
|---|--------------------|--|----------------|
| file descriptor..... | 199, 203, 208, 210 | Immediate Mode Addressing..... | 130 |
| File Modes..... | 327 | Immediate value..... | 72, 309 |
| File Open..... | 209 | index..... | 132 |
| File Open Operations..... | 208 | indirection..... | 130 |
| File Open/Create..... | 210 | input buffer..... | 258 |
| File Operations Examples..... | 212 | Input/Output Buffering..... | 257 |
| File Read..... | 211 | Instruction Pointer Register..... | 12 |
| File Write..... | 211 | Instruction Set Overview..... | 71 |
| First Pass..... | 46 | Integer / Floating-Point Conversion | |
| Flag Register..... | 12 | Instructions..... | 268 |
| Floating-Point Addition..... | 270 | Integer Arithmetic Instructions..... | 80 |
| Floating-Point Arithmetic Instructions..... | 270 | integer numbers..... | 21 |
| Floating-Point Calling Conventions..... | 283 | Interfacing with a High-Level Language | |
| Floating-Point Comparison..... | 280 | | 232 |
| Floating-Point Control Instructions..... | 279 | Interrupt Categories..... | 299 |
| Floating-point destination register operand | | Interrupt Classification..... | 298 |
| | 72, 309 | Interrupt Processing..... | 302 |
| Floating-Point Division..... | 275 | Interrupt Service Routine (ISR)..... | 302 |
| Floating-Point Instructions..... | 265 | Interrupt Timing..... | 298 |
| Floating-Point Multiplication..... | 273 | Interrupt Types..... | 300 |
| Floating-Point Registers..... | 266 | Interrupt Types and Levels..... | 300 |
| Floating-point Representation..... | 24 | Interrupts..... | 297 |
| Floating-Point Square Root..... | 277 | Iteration..... | 118 |
| Floating-Point Subtraction..... | 272 | Jump Out Of Range..... | 115 |
| Floating-Point Values..... | 265 | Jump to ISR..... | 303 |
| forward reference..... | 46 | Labels..... | 112 |
| Function Declaration..... | 173 | leaf function..... | 178 |
| Function Source..... | 230 | Least Significant Byte..... | 15 |
| Functions..... | 171 | light-weight process..... | 291 |
| General Purpose Registers..... | 10 | Linkage..... | 174 |
| GPRs..... | 10 | Linker..... | 47 |
| Hardware Interrupt..... | 299 | Linking Multiple Files..... | 48 |
| heap..... | 17, 148 | Linking Process..... | 48 |
| I/O Buffering..... | 257 | list file..... | 43 |
| IEEE 32-bit Representation..... | 25 | List File..... | 43 |
| IEEE 64-bit Representation..... | 27 | List Summation..... | 133 |
| IEEE 754 32-bit floating-point standard | 24 | little-endian..... | 15p., 151, 241 |
| IF statement..... | 112 | Loader..... | 52 |

Alphabetical Index

| | | | |
|-------------------------------------|-----------------|---|---------|
| Logic Error..... | 162 | operation..... | 71 |
| logical AND operation..... | 106 | ordered floating-point comparisons..... | 279 |
| logical NOT operation..... | 106 | parallel processing..... | 289 |
| logical OR operation..... | 106 | Parallel Processing..... | 289 |
| logical XOR operation..... | 106 | Parameter Passing..... | 176 |
| machine language..... | 17, 43, 45, 240 | Parsing Command Line Arguments..... | 247 |
| Macro Definition..... | 166 | pop operation..... | 145 |
| Macros..... | 165 | POSIX Threads..... | 291 |
| Main Memory..... | 15 | preserved register..... | 177 |
| memory hierarchy..... | 17, 257 | Primary Storage..... | 7, 19 |
| Memory Hierarchy..... | 17 | Privilege Levels..... | 300 |
| memory layout..... | 16, 148 | Process Stack..... | 145 |
| Memory Mode Addressing..... | 130 | Processing Steps..... | 302 |
| Most Significant Byte..... | 15 | processor registers..... | 9 |
| Multi-Line Macros..... | 166 | Program Development..... | 155 |
| Multi-user Operating System..... | 297 | Program Format..... | 33 |
| Multiple Source Files..... | 227 | prologue..... | 175 |
| multiprocessing..... | 290 | push operation..... | 145 |
| Multiprocessing..... | 290 | race condition..... | 291 |
| NaN..... | 27, 279 | Race Conditions..... | 292 |
| Narrowing conversions..... | 76 | Random Access Memory (RAM)..... | 7 |
| Narrowing Conversions..... | 76 | RBP..... | 12 |
| Newline Character..... | 198 | Red Zone..... | 180 |
| Next / Step..... | 60 | register..... | 10 |
| nexti..... | 169 | Register Mode Addressing..... | 130 |
| non-volatile memory..... | 8 | Register operand..... | 72, 309 |
| NOP slide..... | 243 | Register Usage..... | 177 |
| normalized scientific notation..... | 25 | resb..... | 36 |
| not a number..... | 27, 279 | resd..... | 36 |
| Not a Number (NaN)..... | 27 | resdq..... | 36 |
| Notation..... | 309 | resq..... | 36 |
| Notational Conventions..... | 71 | Resumption..... | 304 |
| Numeric Values..... | 33 | resw..... | 36 |
| object file..... | 43 | Return Codes..... | 325 |
| Obtaining ISR Address..... | 302 | rFlags..... | 12 |
| offset..... | 132 | RIP..... | 12 |
| Operand Notation..... | 72, 309 | RSP..... | 12 |
| operands..... | 71 | Run / Continue..... | 60 |

| | | | |
|---------------------------------------|---------|--|---------|
| Run-time Error..... | 161 | Starting DDD..... | 55 |
| S-NaN..... | 279 | stepi..... | 169 |
| saved register..... | 177 | string..... | 29 |
| Second Pass..... | 46 | Summary..... | 190 |
| secondary storage..... | 8 | Suspension..... | 302 |
| Secondary Storage..... | 7, 19 | Suspension Execute ISR..... | 303 |
| section .bss..... | 35 | Suspension Interrupt Processing Summary | 304 |
| section .data..... | 34 | symbol table..... | 46 |
| section .text..... | 36 | Synchronous Interrupts..... | 298 |
| segment fault..... | 239 | system call..... | 197 |
| Setting Breakpoints..... | 57 | System Services..... | 197 |
| short-jump..... | 115 | Text Section..... | 36 |
| sign extension..... | 109 | thread..... | 291 |
| sign-extend..... | 78 | Tool Chain..... | 41 |
| signed..... | 21 | Two-Pass Assembler..... | 45 |
| Signed Conversions..... | 78 | two's complement..... | 22p. |
| Single Instruction Multiple Data..... | 13 | Unconditional Control Instructions..... | 112 |
| Single-Line Macros..... | 165 | Understanding a Stack Buffer Overflow | 238 |
| Software Interrupts..... | 300 | Unicode..... | 29 |
| source file..... | 43 | uninitialized data..... | 17, 148 |
| Source operand..... | 72, 309 | unordered floating-point comparisons.. | 279 |
| stack buffer overflow..... | 237 | unsafe function..... | 239 |
| Stack Buffer Overflow..... | 237 | unsigned..... | 21 |
| Stack Dynamic Local Variables..... | 172 | Unsigned Conversions..... | 77 |
| Stack Example..... | 151 | Updated Linking Instructions..... | 171 |
| stack frame..... | 178 | Using a Macro..... | 166 |
| Stack Implementation..... | 147 | volatile memory..... | 8 |
| Stack Instructions..... | 146 | Why Buffer..... | 257 |
| Stack Layout..... | 148 | Widening conversions..... | 76 |
| Stack Operations..... | 149 | Widening Conversions..... | 76 |
| Stack Pointer Register..... | 12 | %define..... | 165 |
| stack smashing..... | 237 | | |
| Stack-Based Local Variables..... | 187 | | |
| Standard Calling Convention..... | 173 | | |